



**Aladin A1
User Manual**

deep down you want the best

scubapro.com

ALADIN A1 USER MANUAL

The A1 diving computer watch – designed for everyday life and diving.

Welcome to SCUBAPRO dive computers and thank you for purchasing the A1. You are now the owner of an extraordinary partner for your dives and everyday life. This manual provides you with easy access to SCUBAPRO state-of-the-art technology and the A1's key features and functions. Should you wish to know more about SCUBAPRO diving equipment, please visit our website www.scubapro.com



▲ IMPORTANT

Before using your SCUBAPRO A1, please carefully read and understand the Read First booklet that is included in the package.

▲ WARNING

- The A1 has a depth rating of 120m/394ft.
- At depths between 115m/377ft and 120m/394ft in Dive mode the A1 provides alerts about the maximum depth, and at depths over 120m/394ft the A1 automatically switches to Gauge mode and cannot be used as a decompression computer for the remaining time of the dive.
- Diving at oxygen partial pressures higher than 1.6bar (corresponding to a depth of 67m/220ft when breathing compressed air) is extremely dangerous and could lead to serious injury or death.
- Never risk your life on only one source of information. Eventually, every computer has the potential to fail, so do not depend exclusively upon it and always have a plan for how to handle failures. Use a redundant dive computer, carry backup tables and depth/time instrumentation.

▲ WARNING

The A1 is delivered in deep sleep mode where the display is off. You must activate the A1 with a press-and-hold of the SEL/ESC button before the first dive.



The A1 dive instrument is compliant with the European Union directive 2014/30/EU.

Standard EN 13319: 2000

The A1 dive instrument is also compliant with the European standard EN 13319: 2000 (EN 13319: 2000 – Depth gauges and combined depth and time measuring devices – Functional and safety requirements, tests methods).

TABLE OF CONTENTS

1. INTRODUCTION TO THE A1	8
1.1 Switching on the A1	8
1.2 The watch screen	8
1.3 A1 buttons	9
1.4 Button lock	9
1.5 Bezel markings and symbols	10
1.6 Battery	11
1.7 Operation modes	11
1.8 Basic settings	13
1.8.1 Time and date settings	13
1.8.2 User settings	14
2. A1 AS AN EVERYDAY WATCH	14
2.1 Clock setting functions	14
2.1.1 Setting the alarm clock	15
2.1.2 Setting UTC 1	15
2.1.3 Setting UTC 2	15
2.1.4 Setting the time	15
2.1.5 Setting the date	16
2.1.6 Display design	16
2.1.7 Time format	17
2.2 Sport mode	17
2.2.1 Stopwatch	18
2.2.2 Swim mode	18
2.2.3 Apnea mode	19
2.3 Reading the altitude, barometric and temperature values	19
3. A1 SETTINGS AND MENUS ON THE SURFACE	20
3.1 General settings	20
3.1.1 User settings	20
3.1.1.1 Backlight	20
3.1.1.2 Contrast	20
3.1.1.3 Units	21
3.1.1.4 Owner information	21
3.1.1.5 Desaturation reset	21
3.1.1.6 Service Information	22
3.1.2 Swim settings	22
3.1.3 Sound settings	23
3.1.3.1 Buzzer	24
3.1.3.2 Button beeps	24
3.1.3.3 Dive warnings	24
3.1.4 Checking the battery status	24
3.2 Dive settings on surface	25
3.2.1 Dive mode selection	25
3.2.2 Scuba mode settings	25
3.2.2.1 Water type selection	26
3.2.2.2 Microbubble level selection	26
3.2.2.3 Dive display type	26
3.2.3 Apnea mode settings	27
3.2.3.1 Total Apnea exercise depth	27
3.2.3.2 Surface interval factor	27
3.2.3.3 Dual depth alarm	28

3.2.3.4	Dive depth incremental alarm.....	29
3.2.3.5	Dive time interval alarm.....	29
3.2.3.6	Surface interval alarm.....	29
3.2.3.7	Ascent speed alarm.....	30
3.2.4	Warning settings.....	30
3.2.4.1	Dive time warning.....	30
3.2.4.2	Dive depth warning.....	31
3.2.4.3	MOD alarm.....	31
3.3	Gas settings.....	31
3.3.1	Setting gas oxygen content.....	31
3.3.2	Nitrox reset time.....	32
3.4	Planning a dive.....	32
3.4.1	No-stop plan.....	33
3.4.2	Decompression plan.....	33
3.5	Reading the logbook.....	34
4.	DIVING WITH THE A1.....	35
4.1	Display information.....	35
4.1.1	Dive ready mode.....	36
4.1.2	Display configuration during the dive.....	36
4.1.2.1	SCUBA mode display selection.....	36
4.1.2.1.1	Light version.....	37
4.1.2.1.2	Classic version.....	37
4.1.2.2	GAUGE mode display selection.....	38
4.1.2.2.1	Light version.....	38
4.1.2.2.2	Classic version.....	39
4.1.2.3	APNEA mode.....	39
4.2	Safety stop timer.....	40
4.3	Activating the backlight.....	40
4.4	Alarms and warnings during diving.....	40
4.4.1	Maximum depth warning.....	40
4.4.2	MOD (ppO ₂) alarm.....	41
4.4.3	Dive time warning.....	41
4.4.4	Turning time.....	41
4.4.5	No-stop time = 2 minute warning.....	41
4.4.6	No-stop time warning.....	41
4.4.7	CNS O ₂ warning (over 75%).....	41
4.4.8	CNS O ₂ alarm (100%).....	42
4.4.9	LO no-stop time = 2 minute warning.....	42
4.4.10	Entering decompression warning.....	42
4.4.11	Missed decompression stop alarm.....	42
4.4.12	MB level stop ignored.....	42
4.4.13	MB level reduction warning.....	42
4.4.14	Ascent rate alarm.....	43
4.4.15	SOS.....	43
4.4.16	Low battery alarm.....	44
4.5	No-Dive warning.....	44
4.6	No-Fly time.....	44
4.7	Diving with MB-levels.....	45
4.8	PDIS (Profile Dependent Intermediate Stop).....	46
4.8.1	Introduction to PDIS.....	46
4.8.2	How does PDIS work?.....	47
4.8.3	Diving with PDIS.....	48

4.9	Altitude diving	48
4.9.1	Altitude warning after a dive	48
4.9.2	Altitude and the decompression algorithm	49
4.9.3	Prohibited altitude	49
4.9.4	Decompression dives in mountain lakes	50
4.10	Diving with Nitrox	50
4.11	Diving in GAUGE mode	51
4.12	Diving in APNEA mode	52
5.	INTERFACES FOR THE A1 AND AN INTRODUCTION TO LOGTRAK	53
5.1	Establishing Bluetooth communication	53
5.2	LogTRAK	54
5.2.1	Connecting the A1 with LogTRAK	54
5.2.2	Download dive profiles	54
5.2.3	Reading computer information	55
5.2.4	Writing owner information with LogTRAK	55
5.2.5	Setting units in LogTRAK	55
5.2.6	Updating your A1	56
6.	TAKING CARE OF YOUR A1	57
6.1	Changing the watch strap	57
6.2	Display protection foil	58
6.3	Technical information	58
6.4	Maintenance	59
6.5	Warranty	59
6.6	Compliance	60
6.6.1	EU Radio directive	60
6.6.2	Diving	60
6.6.3	FCC & ISED regulatory notices	60
6.6.3.1	Modification Statement	60
6.6.3.2	Interference Statement	60
6.6.3.3	Wireless Notice	60
6.6.3.4	FCC Class B Digital Device Notice	60
6.6.3.5	CAN ICES-3 (B) / NMB-3 (B)	60
6.7	Manufacturer	61
7.	GLOSSARY	62
8.	INDEX	63

1. INTRODUCTION TO THE A1

Your A1 user manual is divided into the following main chapters:

Introduction to the A1. This chapter provides an overview of the A1 dive computer and describes its operating modes and main functions when on the surface.

A1 as an everyday watch. This chapter describes the A1's operation when it is used as a watch.

A1 settings and menus on the surface. This section goes through the settings of your A1.

Diving with the A1. This section takes you underwater with the A1 and describes all settings and functions of the A1 as a dive computer. It outlines everything the A1 can—and will—do to enhance your safety and fun underwater.

Interfaces for the A1 and an introduction to LogTRAK. This section describes how to download data, change settings, and manage your logbook.

Taking care of your A1. This chapter describes how you should take care of your A1 after underwater adventures, and also summarizes the main technical information of this instrument.

The A1 is a technologically-advanced instrument that can accompany you during your underwater adventures while providing you with accurate depth, time and decompression information. On the surface its size makes it your ideal everyday companion. With features such as wake-up alarm, dual time, stopwatch, barometer, altimeter and swim mode, the A1 can tackle almost every possible task. The buttons allow you to initiate operating functions, make setting changes and access menus while on the surface. During the dive they show additional information on the computer screen and activate the backlight.

Now it is time to dive into the details. We hope you will enjoy getting to know your new computer and we wish you many happy dives with the A1.

1.1 Switching on the A1

The A1 is delivered to you in a deep sleep mode. This is done to preserve battery life and ensure your A1 arrives with a fresh battery.

In order to switch on the A1 for the first time you need to press-and-hold the SEL/ESC button (lower left). After this initial activation, the A1 will never again return to deep sleep mode.

1.2 The watch screen

When the A1 is switched on the first time the display screen shows the time and date as follows:



The time and date values, along with the format, can be changed to your liking. This is described in chapters **2.1.6 Display design** and **2.1.7 Time format**.

1.3 A1 buttons

The functions of the buttons **on the surface** are summarized in the table below and explained in detail in the following sections.



1.4 Button lock

A simultaneous press-and-hold of the SEL/ESC and -/DOWN buttons will lock the main time and date display. Once locked, by pressing just the SEL/ESC button the following screen will be displayed:

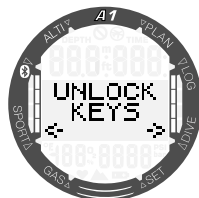

Unlock the display by simultaneously pressing-and-holding the SEL/ESC and -/DOWN buttons again.

“LIGHT” button, Top Left:	Press = backlight
“SEL/ESC” button, Bottom Left:	Press = select (access main menu and submenus or confirm selection/setting) Press-and-hold = escape (return to previous menu or cancel the setting); from the main time and date display shows the current gas settings
“+/UP” button, Top Right:	Press = adds numerical values, toggles up to the previous menu Press-and-hold = from the main time and date display shows the selected dive mode; from the selected dive mode display activates the swim mode
“-/DOWN” button, Bottom Right:	Press = subtracts numerical values, toggles down to the next menu Press-and-hold = from the main time and date display: shortcut to dive ready mode which shows the main dive settings

1.5 Bezel markings and symbols

In this section the markings and symbols on the A1's outer and inner bezel as well as on its display are explained in detail.

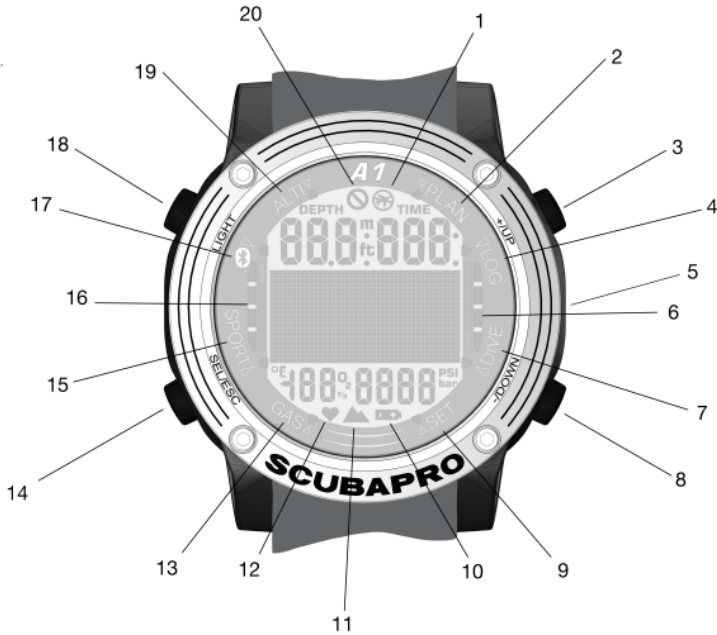

1	No Fly symbol
2	Planner menu indicator
3	+ / UP button
4	Logbook menu indicator
5	Water contact
6	Not used in the A1
7	Dive menu indicator
8	- / DOWN button
9	Settings menu indicator
10	Low battery symbol

11	Altitude symbol
12	Not used in the A1
13	Gas menu indicator
14	SEL / ESC button
15	Sport menu indicator
16	Ascent speed / N2 bar
17	Bluetooth menu indicator
18	Light button
19	Altimeter menu indicator
20	No-dive symbol

1.6 Battery

The A1 uses a CR2450 battery type. The A1 will alert you when the battery is approaching a critical discharge level by displaying the battery symbol.

A steady symbol means that the battery is low, with some reserve left. At this point the backlight cannot be activated. If the symbol blinks, the battery level is dangerously low and the backlight and alarm tones cannot be activated; diving is not recommended before the battery is replaced by an authorized SCUBAPRO service center.

WARNING

Starting a dive when the battery symbol is blinking can cause the computer to fail during the dive! Have an authorized SCUBAPRO service center replace the battery before any diving activity if the blinking battery symbol appears. When the 'do not dive' symbol appears with the battery symbol, the A1 cannot be used for diving until a fresh battery is installed.



Please refer to chapter **3.1.4 Checking the battery** status for details on how to manually trigger the battery level check.

WARNING

The A1 will not start a dive if the battery has reached the critical level indicated by the battery symbol. In this state the A1 cannot be used for diving.

WARNING

When your A1's battery reaches the end of its lifetime, it is recommended that it be replaced by an authorized SCUBAPRO service center.

 WARNING	
<ul style="list-style-type: none"> • INGESTION HAZARD: This product contains a button cell or coin battery. • DEATH or serious injury can occur if ingested. • A swallowed button cell or coin battery can cause Internal Chemical Burns in as little as 2 hours. • KEEP new and used batteries OUT OF REACH OF CHILDREN • Seek immediate medical attention if a battery is suspected to be swallowed or inserted inside any part of the body. 	

WARNING

- Remove and immediately recycle or dispose of used batteries according to local regulations and keep away from children. Do NOT dispose of batteries in household trash or incinerate.
- Even used batteries may cause severe injury or death.
- Non-rechargeable batteries are not to be recharged.
- Do not force discharge, recharge, disassemble, heat above 50°C or 122°F or incinerate. Doing so may result in injury due to venting, leakage or explosion resulting in chemical burns.

WARNING

- Ensure the batteries are installed correctly according to polarity (+ and -)
- Remove and immediately recycle or dispose of batteries from equipment not used for an extended period of time according to local regulations.
- Always completely secure the battery compartment. If the battery compartment does not close securely, stop using the product, remove the batteries, and keep them away from children.

1.7 Operation modes

The A1's different modes are shown on the dial ring of the computer and the current function mode is indicated with an arrow. Each mode may have sub functions and menus. By pressing the SEL/ESC button you activate the mode and as an indication the arrow starts blinking.

The modes are grouped and described in this manual in four chapters:

1. A1 as an everyday watch.
2. A1 settings and menus.
3. A1 as a dive computer.
4. Bluetooth interface of the A1 and an introduction to LogTRAK.

The A1 has two main operation modes:

1. **Watch mode.** The display is on and shows the time and date (in various formats). From this mode other surface operation modes can be selected:
 - a. Sport mode
 - b. Bluetooth communication mode
 - c. Altimeter
 - d. Planner
 - e. Logbook

As well as settings can be changed:

- a. Dive settings
- b. Custom settings
- c. Gas settings
2. **Dive mode.** This mode is activated when the computer reaches a depth of 0.8m/3ft or more. In this mode the A1 monitors depth, time, temperature and decompression.

The following chart describes the main menu structure:

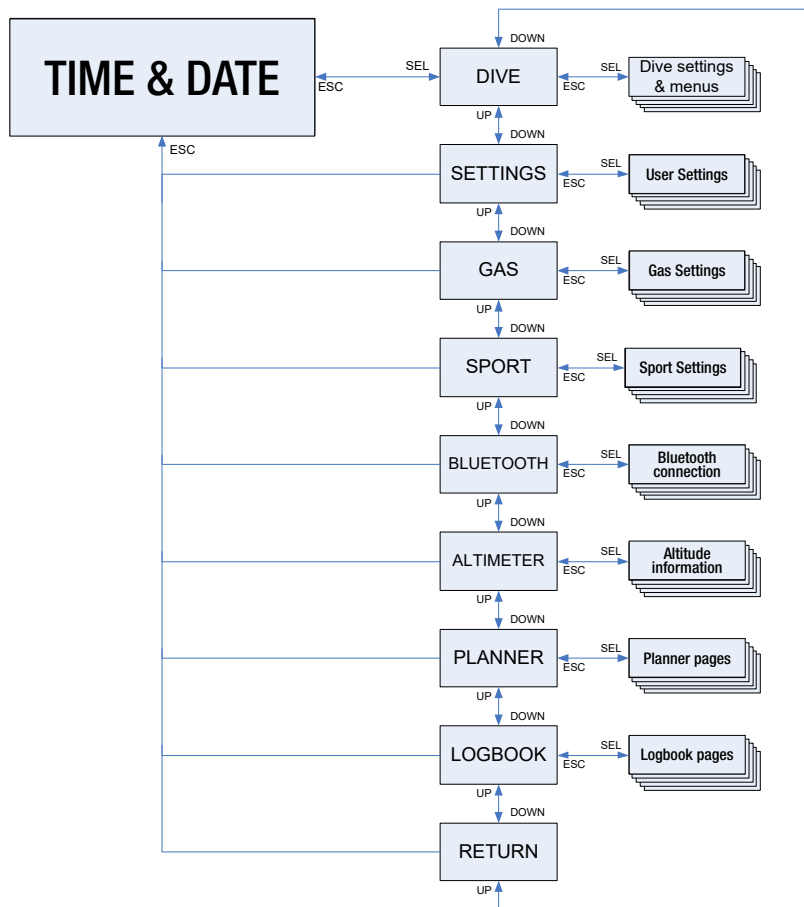

1.8 Basic settings

The initial activation of your A1 requires some basic set-up (setting time and date, units, etc.).

1.8.1 Time and date settings

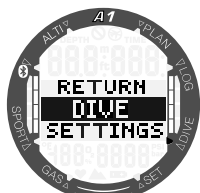

Starting from the main time and date display, pressing the SEL/ESC button takes you to the main menu.

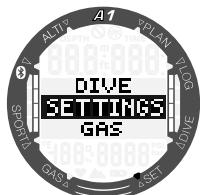

From the main menu toggle down to **Settings** with the -/DOWN button then press SEL/ESC.

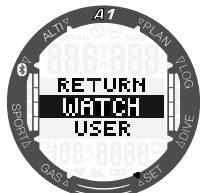

From the **Settings** menu toggle down to **Watch** then press SEL/ESC.

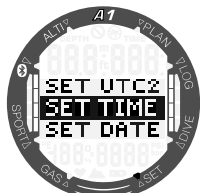

From the **Watch** menu toggle down to **Set Time** then press SEL/ESC.

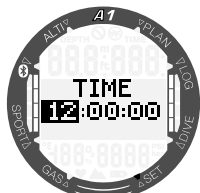

By pressing +/UP or -/DOWN you can select the hours and confirm them by pressing SEL/ESC. The minutes can be set the same way.

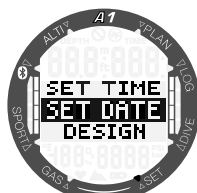

After the minutes are confirmed the date can be adjusted the same way.

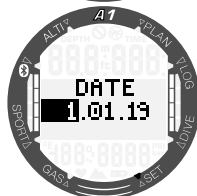

There are additional watch settings that you can adjust to your liking. These are described in chapter **2.1 Clock setting functions**.

1.8.2 User settings

The user-related settings (backlight duration, display contrast, units, etc.) can be selected with a press-and-hold of the SEL/ESC button which returns you to the previous submenu.

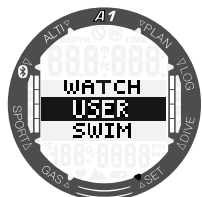

For example, from the **Settings** menu, toggle down to **User**, then press SEL/ESC.



From the **User** menu, toggle down to **Units**, then press SEL/ESC.

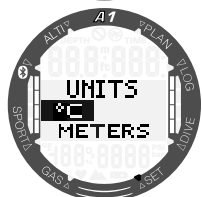

Now the various units can be selected. These selections are effective in all operating modes; for example, during diving your depth can be shown in meters or in feet.

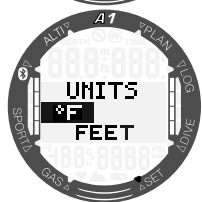

2. A1 AS AN EVERYDAY WATCH

The A1 is more than just a watch. It features:

- Stopwatch with lap time and 72 hours of run time.
- Swim stroke and distance counter.
- Altimeter for tracking your excursions to the mountains.
- Thermometer and barometer for current weather conditions.
- Wake-up alarm function.
- Dual time.

2.1 Clock setting functions

Starting from the main time and date display, press the SEL/ESC button to enter the main menu.

From the main menu, toggle down to **Settings** with the -/DOWN button, then press SEL/ESC. From the **Settings** menu select **Watch** to enter the clock settings.

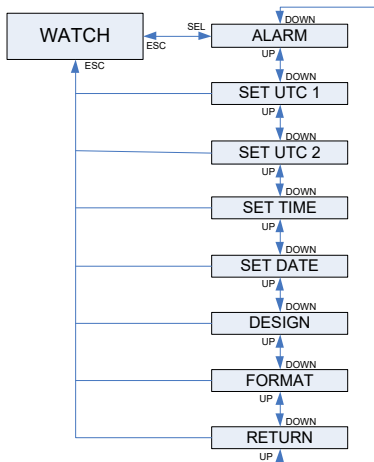

2.1.1 Setting the alarm clock

From the **Watch** menu press the SEL/ESC button to enter the **Alarm** submenu. Here you can activate or deactivate the alarm clock by pressing the +/UP or -/DOWN buttons. Selecting **ALARM ON** will allow you to set the time of the alarm. You can scroll the hours by pressing +/UP or -/DOWN buttons. Pressing the SEL/ESC button will confirm the hour setting and switch to minutes. You can scroll the minutes by pressing +/UP or -/DOWN buttons. Pressing the SEL/ESC button will confirm the minutes setting and activate the alarm.

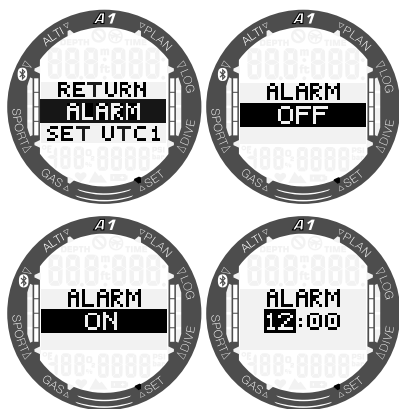

2.1.2 Setting UTC 1

The UTC setting will change the displayed time compared to Greenwich 0-Meridian. This feature is practical when traveling through different time zones. By pressing SEL/ESC you may edit the hours with +/UP or -/DOWN buttons in a range of +14h to -13h. By pressing SEL/ESC the minutes will be highlighted and you may edit them with +/UP or -/DOWN buttons in 15-minute increments. The UTC 1 setting will be confirmed by pressing the SEL/ESC button.

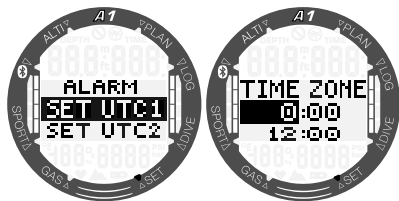

2.1.3 Setting UTC 2

Dual time uses the same “base time” as the main clock. Therefore, adjusting the time as described in section ‘Setting the time’ will also influence the dual time. The dual time zone selection will define the difference to the main clock time. When the time zone selection is OFF, then the dual time is disabled. When pressing the SEL/ESC button the UTC 2 time hours will be highlighted. You may change the setting by pressing the +/UP or -/DOWN buttons in a range of +14h to -13h or by selecting OFF. By pressing the SEL/ESC button, the minutes will be highlighted and you may edit them using the +/UP or -/DOWN buttons in 15-minute increments. The UTC 2 setting will be confirmed by pressing the SEL/ESC button.

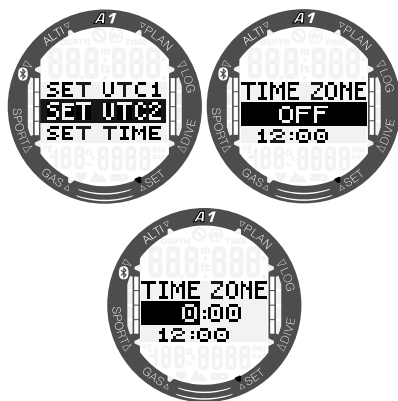

2.1.4 Setting the time

By pressing the SEL/ESC button in the **Set Time** submenu the time setting will be activated. You may change the hours with +/UP or -/DOWN buttons. By pressing the SEL/ESC button the selection will change to minutes and can be edited. The new time setting will be confirmed by pressing the SEL/ESC button.

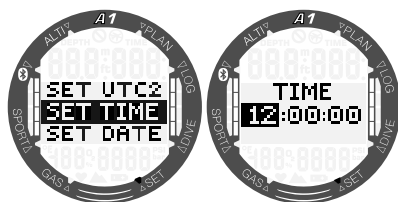

NOTE: seconds cannot be edited; they always start counting from 0.

2.1.5 Setting the date

By pressing the SEL/ESC button in the **Set Date** submenu the first two digits will be highlighted. You may change them by pressing the +/ UP or -/DOWN buttons. Change the selection to the next two digits by pressing the SEL/ESC button. Finally, set the year by pressing +/ UP or -/DOWN button. In 24h time format the first digits in the date are days, in AM/PM time format the month is first. You can toggle between 24h and AM/PM in the **Format** submenu.

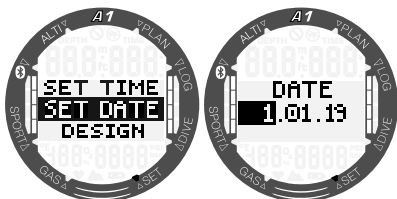

2.1.6 Display design

In this menu you may select the design of the main time and date display to suit your personal preferences by scrolling through the options with the +/ UP or -/DOWN buttons. Confirm your selection by pressing the SEL/ESC button. In the following screens the display design selection is shown next to how the layout is presented on the main watch display screen.



2.1.7 Time format

Choose your preferred time format by scrolling with the +/- UP or -/DOWN buttons, press the SEL/ESC button to save your settings. You can choose between AM/PM or 24h format.

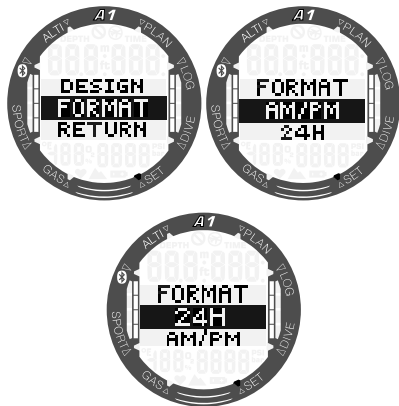

NOTE: Time format will also change the date format: MM/DD/YY in AM/PM mode and DD/MM/YY in 24h mode. This change will take place, for example, in watch mode, logbook, etc.

2.2 Sport mode

Starting from the main time and date display, press the SEL/ESC button to enter the main menu, then toggle down to enter the **Sport** menu, and press the SEL/ESC button again to enter the **Sport** menu. In this menu sport-related functions like swim stroke counter and stopwatch can be activated.

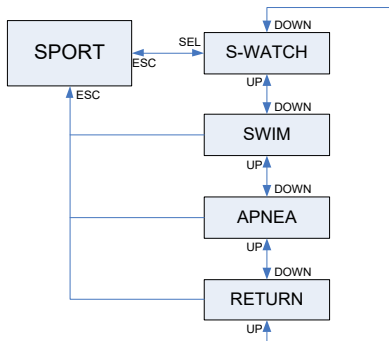

The functions of the buttons in **Sport mode** are summarized in the table below and explained in detail in the following sections.

“LIGHT”	Press = backlight Press-and-hold in Stopwatch mode = returns to the main time and date display (stopwatch will still be running in the background)
“SEL/ESC”	Press in Swim mode = stops/restarts timer Press-and-hold in Swim mode = ends swim exercise Press in Stopwatch mode = returns to Sport menu Press-and-hold in Stopwatch mode = returns to Sport menu
“+ /UP”	Press in Swim mode = scrolls through the alternative displays Press-and-hold in Swim mode = ends swim exercise Press in Stopwatch mode = manually start/stop timer Press-and-hold in Stopwatch mode when timer stopped = reset timer to zero
“- /DOWN”	Press in Swim mode = scrolls through the alternative displays Press in Stopwatch mode when timer stopped = scrolls through laps

2.2.1 Stopwatch

From the **Sport** menu press SEL/ESC to enter the **Stopwatch** submenu.

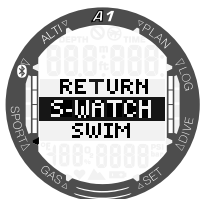

The stopwatch will start measuring the time by pressing the +/UP button.

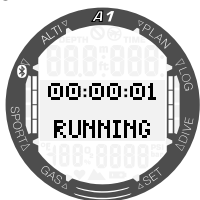

To pause the time on the stopwatch press the +/UP button once again. To reset the time to 0 press-and-hold the +/UP button while the stopwatch display shows the status STOPPED.

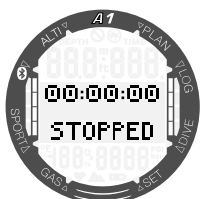

In addition to time, laps can be marked by pressing the -/DOWN button while the stopwatch is running. By doing so the lower part of the screen will show the number of the lap while the lap time will be displayed in the upper part of the screen. While the stopwatch is stopped you can review your lap times from the memory by repeatedly pressing the -/DOWN button.

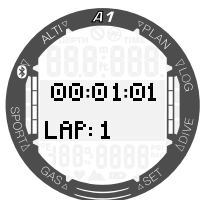

By pressing-and-holding the SEL/ESC button you can exit the stopwatch and return to the **Sport** menu.

NOTE: You can leave the stopwatch actively counting or you can leave the stopped time on the display. The status will be stored in memory, allowing you to continue from the same display at a future time.

2.2.2 Swim mode

Swim mode combines a stopwatch with a stroke and distance counter. For proper counter operation the user's pending values can be adjusted. These are described in chapter **3.1.2 Swim settings**.

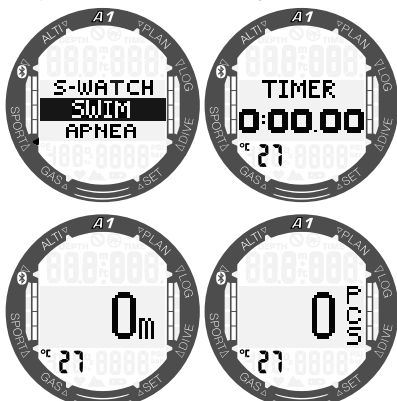

When the swim mode is activated, the duration of your swim will be shown on the second screen. The distance will be displayed on the third screen and the last screen will show the number of swim strokes. The water temperature is shown in the bottom left of the display. Switch between displays by pressing the +/UP or -/DOWN buttons. A press of the SEL/ESC returns you to the **Sport** menu.

 **NOTE:** Swim mode stays active in shallow water down to 3 meters. This allows flip turns in pool and horizontal dives. An immersion deeper than 3 meters will start a dive in the mode which is selected in the A1 (SCUBA, APNEA or GAUGE).

2.2.3 Apnea mode

Apnea exercise mode can be activated from this next menu. The session starts with a surface interval.

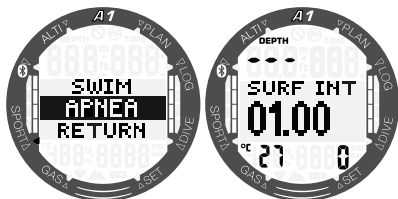

Apnea mode settings are described in chapter **3.2.3 Apnea mode settings**. Display information and diving with this mode is described in chapter **4.1.2.3 APNEA mode**.

2.3 Reading the altitude, barometric and temperature values

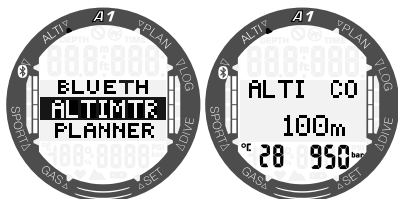

From the main menu toggle to the **Altimeter (Altimtr)** menu, and press the SEL/ESC button to enter. In the **Altimtr** menu, on the first display the current altitude (in meter or feet) is calculated from the barometric pressure and shown in the middle of the screen. The temperature (in Celsius or Fahrenheit) and air pressure (in mbar) at your current altitude are displayed in the bottom left and bottom right of the screen, respectively.

 **NOTE:** barometric pressure is a variable, changing with weather and atmospheric pressure at a particular elevation. The Dive algorithm uses Altitude Classes which are directly derived from the barometric pressure. Altitude is counted from the current barometric pressure and is therefore a relative value.



By pressing the +/UP or -/DOWN buttons you can switch to an additional display where the atmospheric pressure at sea level is shown.

The altitude can be adjusted when current elevation is known by pressing the SEL/ESC button. The new altitude value will be highlighted in the center of the screen. By pressing +/UP or -/DOWN buttons the value can be adjusted in 10m/50ft increments.

This Barometer feature allows you to foresee approaching weather in the upcoming hours if your altitude remains the same.

3. A1 SETTINGS AND MENUS ON THE SURFACE

In this chapter the settings that can be completed on the surface are described. These settings will allow you to personalize your A1 as desired.

3.1 General settings

In the **Settings** menu the following functions can be set:

- Watch settings – please refer to chapter **2.1 Clock setting functions**.
- User settings – backlight, display contrast, units, owner info, desaturation reset, service check, current software version.
- Swim settings – swim stroke depth and length.
- Sound settings – enable or disable button beeps, dive warnings.
- Battery – check battery status.

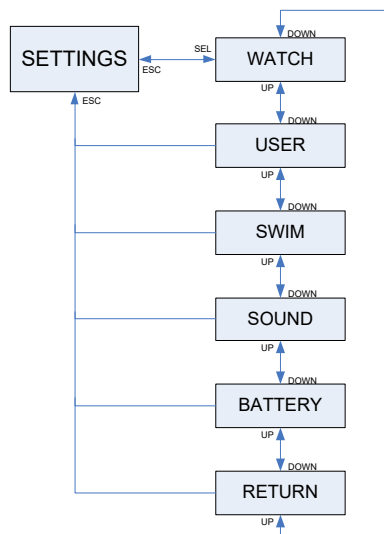

3.1.1 User settings

This section allows you to customize your A1 to your liking. Settings like backlight duration, display contrast and units can be changed here.

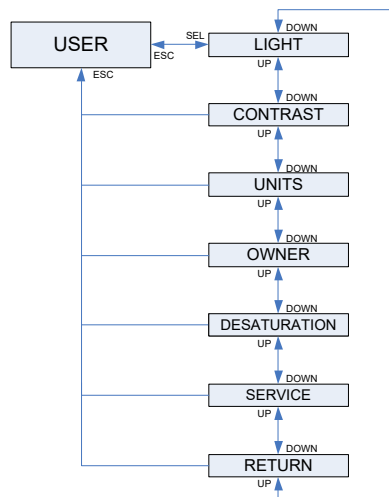

3.1.1.1 Backlight

In the **User** submenu press SEL/ESC to access the backlight settings. The duration of the backlight can be set from 5 up to 30 seconds using +/UP or -/DOWN buttons and saved with another press of the SEL/ESC button.

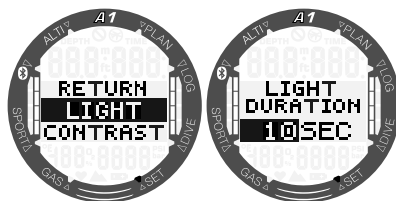

3.1.1.2 Contrast

In the **User** submenu toggle down to **Contrast** and press SEL/ESC to access display contrast settings. Contrast can be set from 0 up to 15 using +/UP or -/DOWN buttons and saved with another press of the SEL/ESC button.

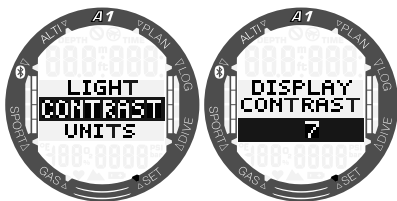

3.1.1.3 Units

Different combinations of temperature and height or depth measurement units can be selected in the Units submenu.

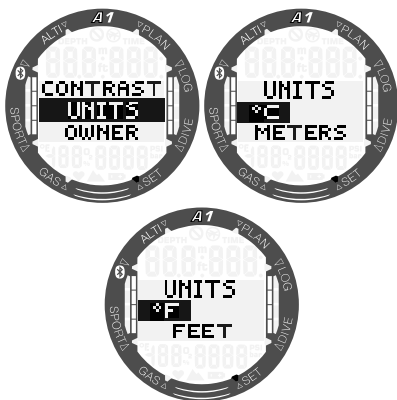

3.1.1.4 Owner information

You can input owner's information using the LogTRAK program. This function is described in detail in chapter 5.2.4 Writing owner information with LogTRAK.

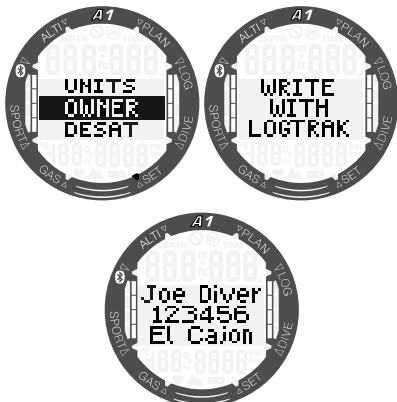

3.1.1.5 Desaturation reset

When the A1 is still counting down the desaturation, some menu changes are not possible. In the event you decide to reset the desaturation, the safety code **313** must be entered. This procedure prevents unwanted resetting and stores the desaturation reset in memory (in the next dive log the desaturation symbol will be shown).

By pressing the SEL/ESC button in the **Desat** submenu, the code page appears. The first digit will be highlighted, and can be edited by pressing the +/UP or -/DOWN buttons. By pressing the SEL/ESC button the number is confirmed and the next number will be highlighted. When the code is entered correctly and then confirmed by pressing the SEL/ESC button, the desaturation reset is complete.

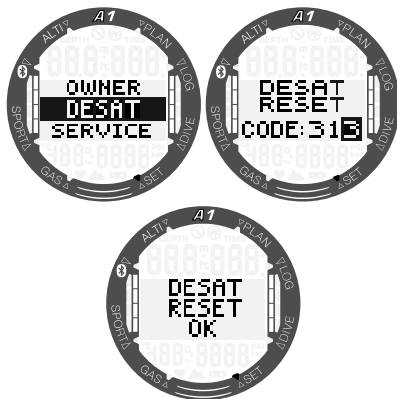

⚠ WARNING

Resetting desaturation will affect calculations of the algorithm which may lead to serious injury or fatal issue. Do not reset desaturation without having a very good reason.

3.1.1.6 Service Information

The date of the last service by an authorized SCUBAPRO dealer is shown in this submenu.

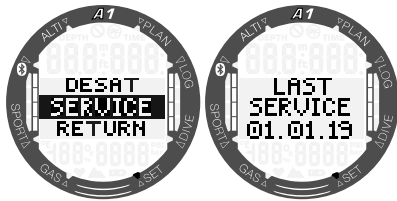

NOTE: Only an authorized SCUBAPRO service center, which has the proper tools and instruments, can reset the service date. The service date is only set after the A1's seals are checked and verified.

Pressing +/UP button from the “last service” screen shows the current software version of the A1. You can download the latest version from the SCUBAPRO website, see chapter **5.2.6 Updating your A1.**

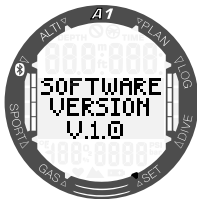

3.1.2 Swim settings

Next on the **Settings** menu listing is **Swim**. Press the SEL/ESC button to enter.

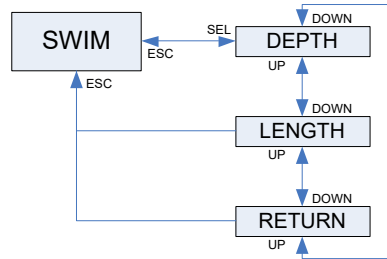

For the swim stroke counter you must set the cycle threshold—how much depth difference is counted as a stroke cycle, as well as the distance per cycle (stroke length)—to achieve the proper result.

The following illustration shows the parameters:

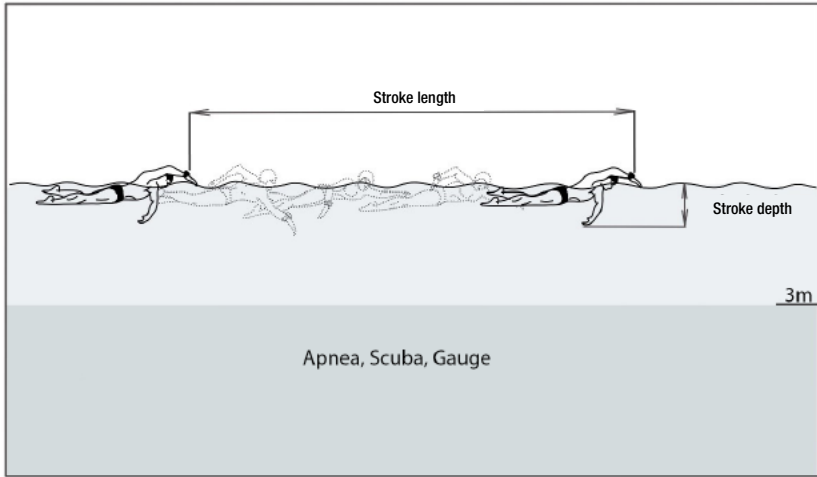

By pressing SEL/ESC in the **Swim** menu, you reach the swim mode settings. By pressing SEL/ESC the counter stroke threshold (first depth, then length) will be highlighted. A too large threshold setting will detect only a large movement as a stroke, a too small setting may detect too many strokes. You must test and adjust this according to your swimming style. By pressing the +/UP or -/DOWN buttons the value can be selected from 2cm/1in to 40cm/16in. A press of the SEL/ESC button saves the setting.

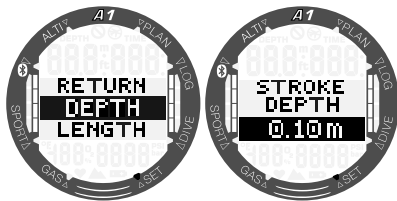

Pressing the SEL/ESC button will take you back to the previous submenu where you can toggle down to the stroke length settings. These values can be set from 0.5m/2ft to 5.0m/16ft by pressing the +/UP or -/DOWN buttons. Confirm your settings by pressing the SEL/ESC button.

To convert each stroke to a distance, the A1 needs an average length of a stroke. This is similar to a pedometer which uses

a step length to convert the distance. You can calibrate this in a swimming pool where you know the length and can use the A1 stroke count to calculate the correct length.

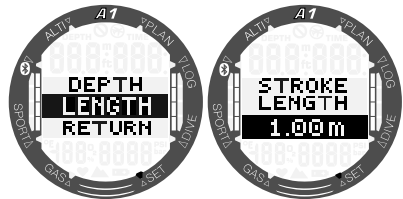

3.1.3 Sound settings

Next on the **Settings** menu listing is **Sound**. Press the SEL/ESC button to enter.

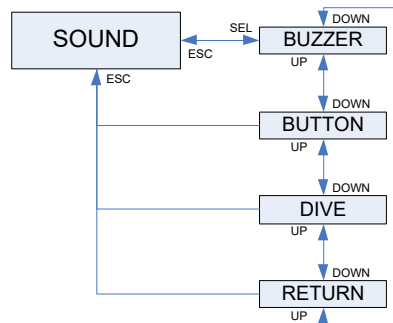

3.1.3.1 Buzzer

When delivered with factory settings the A1 buzzer is active. You can set the A1 to a stealth mode in the **Buzzer** submenu which deactivates all sounds. However, switching off all alarm sounds requires the safety code **313** to prevent accidental deactivation.

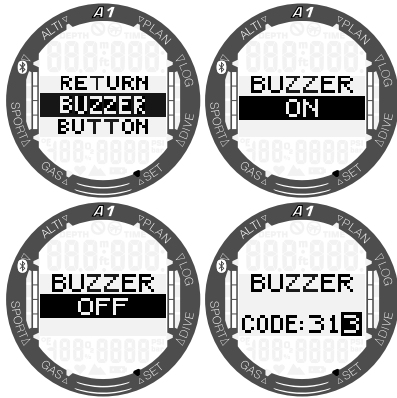

⚠ WARNING

Setting the “BUZZER OFF” will disable all audible dive mode alarms and warnings. This could potentially be dangerous.

3.1.3.2 Button beeps

In this submenu the general button feedback beeps can be enabled or disabled by pressing the +/UP or -/DOWN button followed by SEL/ESC to save the setting.

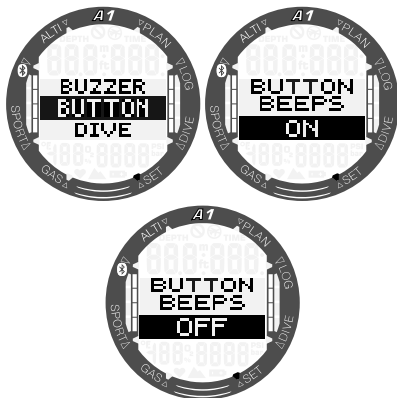

3.1.3.3 Dive warnings

In this submenu the warnings in dive mode can be enabled or disabled by pressing the +/UP or -/DOWN button followed by SEL/ESC to save the setting.

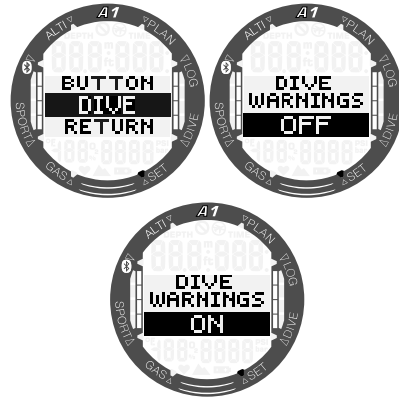

NOTE: Dive alarms are still active even if you switch the dive warnings off. Dive alarms are deactivated only when the buzzer is switched off as described in chapter **3.1.3.1 Buzzer**.

3.1.4 Checking the battery status

When the menu Battery is selected, the A1 shows the last measured battery level.

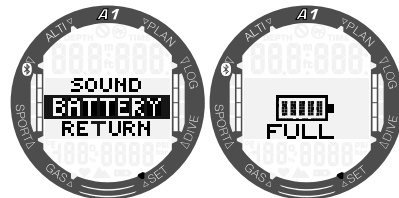

If you press the SEL/ESC button while in this menu, a new measurement will be made. This might take a few seconds; the A1 will display a “please wait” message until the revised battery status is available.

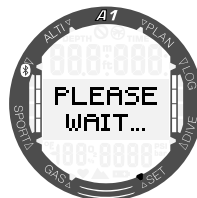

3.2 Dive settings on surface

From the main menu enter the **Dive** menu by pressing the SEL/ESC button.

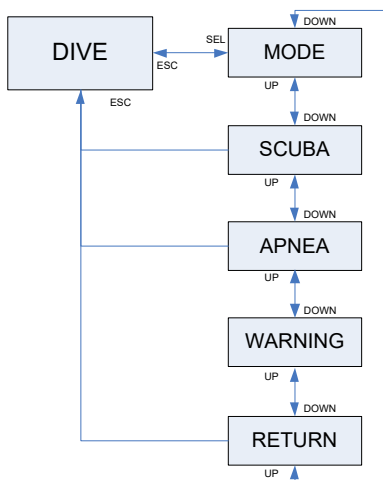

3.2.1 Dive mode selection

The **Mode** menu allows you to select your preferred dive mode: Apnea, Scuba or Gauge mode.

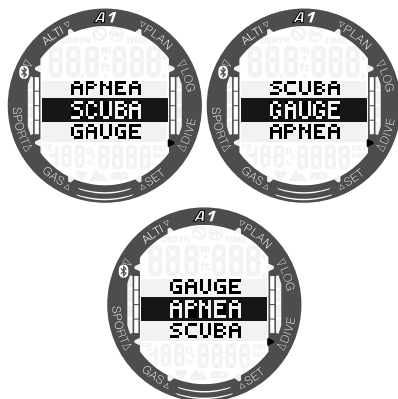
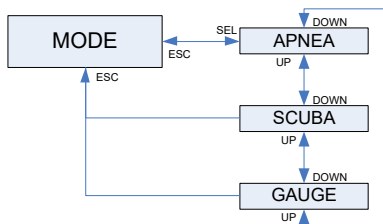

NOTE: The **GAUGE** and **APNEA** modes do not track tissue saturation so there is a locking interval before it is possible to change to **SCUBA** mode. In **GAUGE** mode the locking interval is 48h after the last dive in **GAUGE** mode. In **APNEA** mode there is a 12h locking interval with shallower than 5m/16ft dives, and a 24h locking interval with deeper than 5m/16ft dives in **APNEA** mode.

3.2.2 Scuba mode settings

A set of **SCUBA** related selections are grouped in this menu.

By pressing the SEL/ESC button you can access the following submenus:

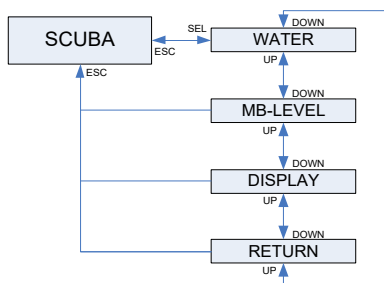

3.2.2.1 Water type selection

The A1 determines depth by measuring pressure using water density as a constant. A 10m/33ft depth in salt water corresponds approximately to 10.3m/34ft in fresh water. By pressing the +/UP or -/DOWN buttons you may select either salt or fresh water. The selection is confirmed by pressing the SEL/ESC button.



☞ *NOTE: This setting will adjust the depth on all modes: SCUBA, GAUGE and APNEA.*

3.2.2.2 Microbubble level selection

By pressing the SEL/ESC button in this menu the Microbubble level will be highlighted. By pressing the +/UP or -/DOWN buttons you may select your personal setting from L0 up to L5.

L5 is the most conservative setting. The selection is confirmed by pressing the SEL/ESC button.

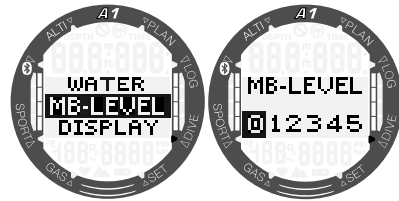

☞ *NOTE: More about diving with microbubble levels can be found in section 4.7 Diving with MB-levels.*

3.2.2.3 Dive display type

In this menu the display type while diving in SCUBA and GAUGE modes can be selected. You will find a more detailed description about diving with light and classic displays in chapter 4.1.2.1 **SCUBA mode display selection** and 4.1.2.2 **GAUGE mode display selection**.

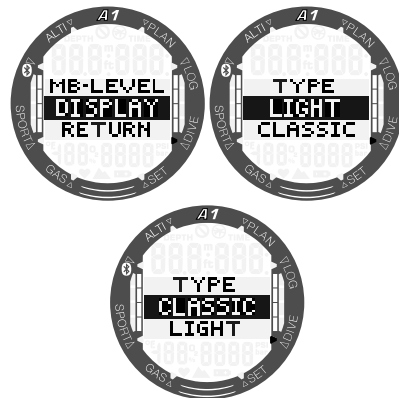

3.2.3 Apnea mode settings

Apnea diving-related selections are grouped in this menu.

By pressing the SEL/ESC button the following submenus can be accessed:

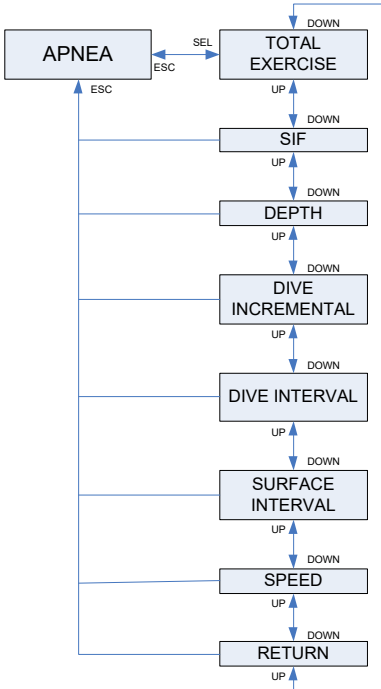

3.2.3.1 Total Apnea exercise depth

To provide a scale of total pressure changes during an Apnea dive session, the A1 includes a total depth counter. By pressing the +/UP or -/DOWN buttons you can set the total depth counter from 100m/300ft to 1000m/3301ft, and save the setting by pressing the SEL/ESC button. When your depth total has been reached the A1 notifies you at the surface with an audible tone and a blinking “no dive” symbol to let you know it’s time to end the session and take a break.

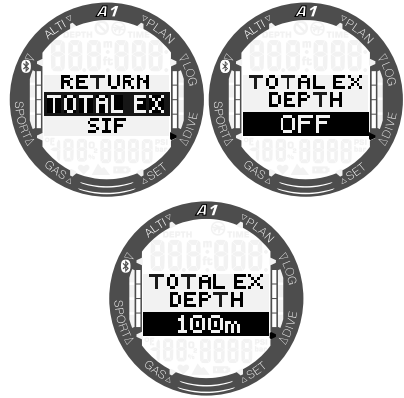

3.2.3.2 Surface interval factor

Apnea diving organizations provide various recommendations regarding surface intervals between dives based on dive times or depths. The A1 integrates a surface interval counter which employs simple multiplication for determining the surface interval in seconds. The A1 uses the following formula to make this calculation:

Surface interval before the next dive = pressure (depth) * square root of dive time * SIF.

As a reference, a few values are listed in the following table:

DIVE DEPTH		DIVE TIME	SURFACE INTERVAL	
m	ft	seconds	seconds (SIF = 5)	seconds (SIF = 20)
10	30	40	63	253
10	30	60	77	309
20	60	60	116	464
30	90	80	178	716
40	120	90	237	949

NOTE: The actual depth and time are calculated during the ascent and descent. This is not presented in the table above.

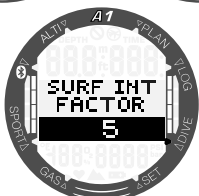
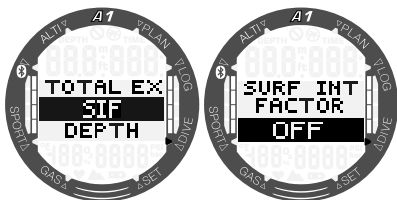

The SIF can be selected from 5 to 20 or disabled with the OFF setting by pressing the +/UP or -/DOWN buttons and then the SEL/ESC button to save.

3.2.3.3 Dual depth alarm

In initial factory settings the dual dive depth alarm is switched off.

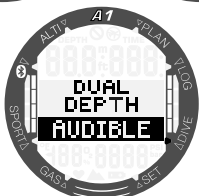
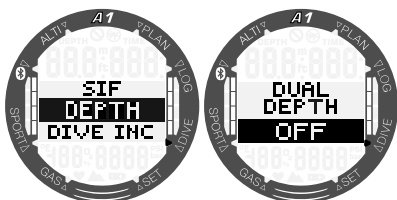

When you select depth and enable the warning by switching it to audible by first pressing the +/UP or -/DOWN buttons and then pressing the SEL/ESC button, the first depth selection is shown. By pressing the SEL/ESC button again, the second depth selection is shown.

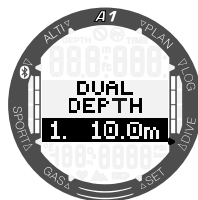

Both depth alarms can be set from 5 to 100 meters (20 to 330 feet) in 1m/5ft increments by pressing the +/UP or -/DOWN buttons. By pressing the SEL/ESC button the first value is confirmed and the second depth can be adjusted.

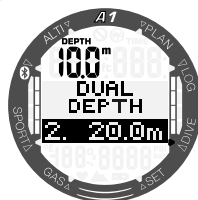

The value of the second alarm can be set the same way as that of the first alarm. In the upper left section of the screen the depth of the first alarm is displayed.

NOTE: The first alarm is short sequence to get your attention, while the second alarm is continuous. By setting the first alarm deeper than the second, it will be masked by the continuous alarm and you may not be able to hear it.

3.2.3.4 Dive depth incremental alarm

In initial factory settings the dive depth incremental alarm is switched off.

You may select the alarm value from 5 to 100m (20 to 330ft) in 1m/5ft increments, and the direction can be selected as UP/DOWN/BOTH. Press the +/UP or -/DOWN buttons to select direction, then the SEL/ESC button, then the +/UP or -/DOWN buttons again to set the depth, followed by a final press of the SEL/ESC button to save the setting.

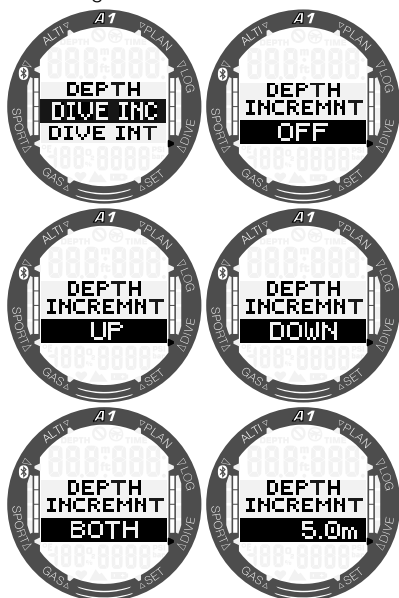

3.2.3.5 Dive time interval alarm

By pressing the SEL/ESC button the function will be highlighted and you may enable or disable the dive time interval alarm by choosing AUDIBLE or OFF by pressing the +/UP or -/DOWN buttons. By selecting AUDIBLE and then pressing the SEL/ESC button the time value will be highlighted, and by pressing the +/UP or -/DOWN buttons you can select the interval from 15 seconds up to 10 minutes in 15 second increments. By pressing the SEL/ESC button again the settings will be confirmed.

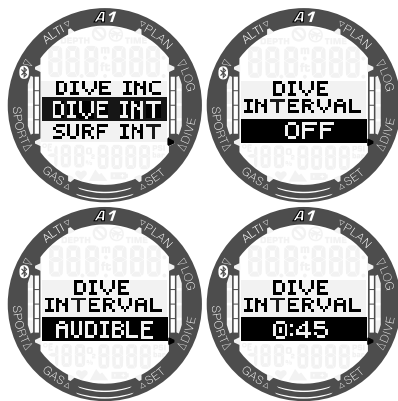

3.2.3.6 Surface interval alarm

By pressing the SEL/ESC button the function will be highlighted and you may enable or disable the surface interval alarm by choosing AUDIBLE or OFF by pressing the +/UP or -/DOWN buttons. By selecting AUDIBLE and then pressing the SEL/ESC button the time value will be highlighted, and by pressing the +/UP or -/DOWN buttons you can select the interval from 15 seconds up to 10 minutes in 15 second increments. By pressing the SEL/ESC button again the settings will be confirmed.

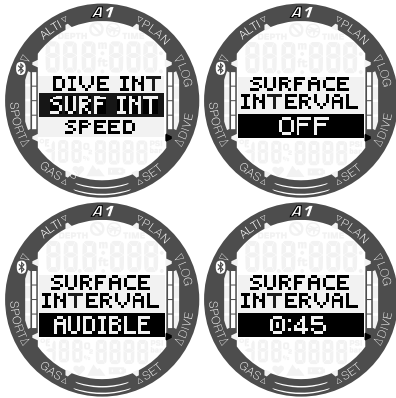

3.2.3.7 Ascent speed alarm

By pressing the SEL/ESC button the function will be highlighted and you may enable or disable the ascent speed alarm by choosing AUDIBLE or OFF by pressing the +/UP or -/DOWN buttons. By selecting AUDIBLE and then pressing the SEL/ESC button the value will be highlighted, and by pressing the +/UP or -/DOWN buttons you can select the interval from 0.1 to 5.0 meters/second (1 to 15 feet/second) in 0.1m/sec or 1ft/sec increments. By pressing the SEL/ESC button again the settings will be confirmed.

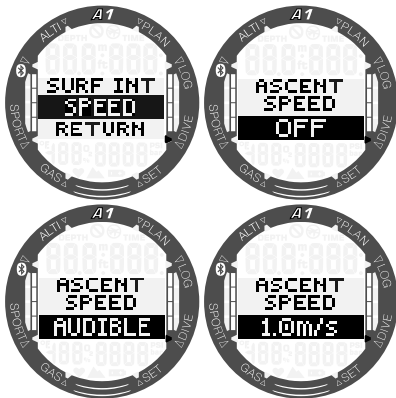

3.2.4 Warning settings

There are three warnings which can be enabled and edited directly in the A1. The rest of the warnings can only be enabled / disabled via SCUBAPRO LogTRAK program. To learn more about the warnings see chapter 4.4 Alarms and warnings during diving.

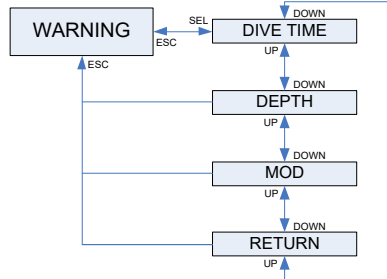

3.2.4.1 Dive time warning

In initial factory settings the dive time warning is switched off. When you select dive time and switch the warning on, the value can be adjusted from 5 to 195 minutes in 5-minute increments by pressing the +/UP or -/DOWN buttons. The selection is confirmed by pressing the SEL/ESC button.

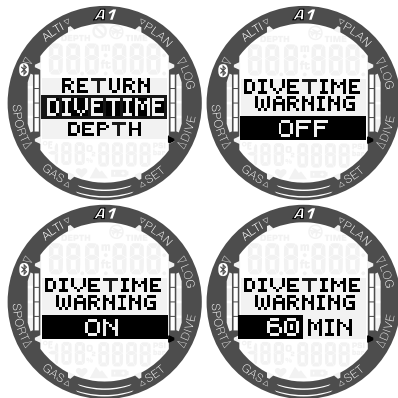

3.2.4.2 Dive depth warning

In initial factory settings the dive depth warning is switched off. When you select dive depth and switch the warning on, the value can be adjusted from 5 to 100m (20 to 330ft) in 1m/5ft increments by pressing the +/UP or -/DOWN buttons. The selection is confirmed by pressing the SEL/ESC button.

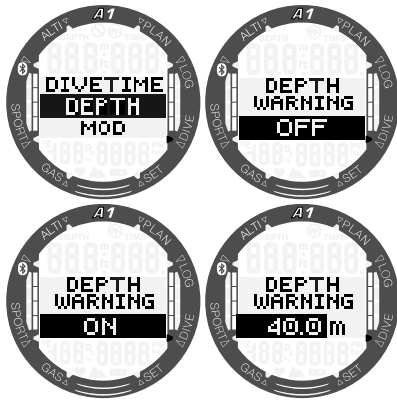

3.2.4.3 MOD alarm

In initial factory settings the MOD alarm is enabled. If the alarm is disabled, this requires the safety code **313** from the user to prevent accidental switching off.

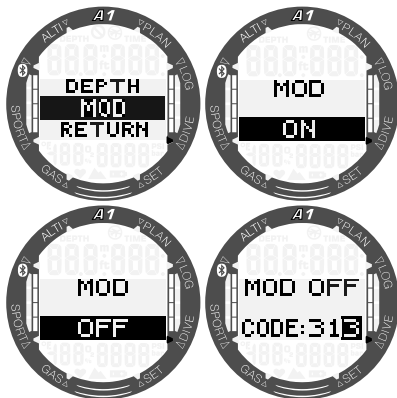

The MOD alarm uses the maximum ppO_2 value which is given at the gas settings and the default value is 1.4bar.

⚠ WARNING

Diving at oxygen partial pressures higher than 1.6bar is extremely dangerous and could lead to serious injury or death.

3.3 Gas settings

In this section gas related settings are described. From the main menu toggle down to the Gas menu, and press the SEL/ESC button to enter.

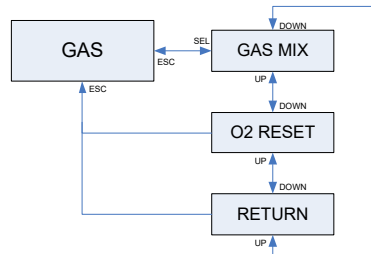

You can use your A1 with all nitrox mixes from air to pure oxygen.

3.3.1 Setting gas oxygen content

By pressing the SEL/ESC button in the **Gas mix** submenu, the oxygen content of the gas will be highlighted. By pressing the +/UP or -/DOWN buttons you may set the value from 21% up to 100%.

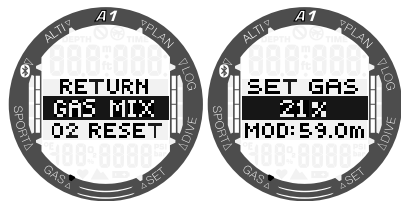

☞ **NOTE:** Setting the gas mix will be disabled if the selected dive mode is Apnea or Gauge.

Once the oxygen content is confirmed by pressing the SEL/ESC button, the selection changes to ppO_2 limit value. By pressing the +/UP or -/DOWN buttons you may select a value from 1.00 bar up to 1.60 bar. A press of the SEL/ESC button will save the selection.

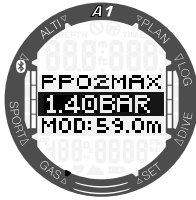

☞ **NOTE:** If you cancel the ppO_2 setting by a press-and-hold of the SEL/ESC button, the oxygen content selection will also be canceled.

WARNING

Diving with a ppO_2 higher than 1.6 bar is dangerous and may lead to unconsciousness, drowning and fatal injury.

☞ **NOTE:** ppO_2 is fixed to 1.60 bar when the selected oxygen content is 80% or higher.

3.3.2 Nitrox reset time

If you are generally diving with air and want to return to this setting after the occasional nitrox dive, you can preset a default time when your A1 will set back to air.

By pressing the SEL/ESC button the time shown on the bottom row will be highlighted. The time can be selected from 1 hour up to 48 hours by pressing the +/UP or -/DOWN buttons. The nitrox reset time can be disabled by pressing the +/UP or -/DOWN buttons until -- h is shown on the display. A press of the SEL/ESC button will save the setting.

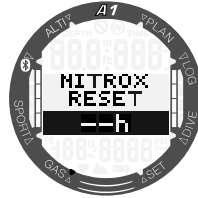
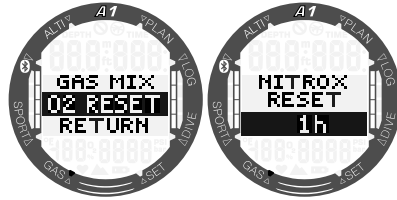

3.4 Planning a dive

You can plan your next dive based on your body's nitrogen saturation. The planner is also using the following information:

1. Selected oxygen concentration.
2. Selected water type.
3. Selected microbubble level.
4. Water temperature of the most recent dive.
5. Altitude range.
6. Status of saturation at the time when the planner is activated.
7. Observance of the prescribed ascent rates.

To activate the new plan, scroll to the menu **Planner** and press the SEL/ESC button.



3.4.1 No-stop plan

If you have completed a dive but plan to make another during the desaturation phase, you must start the planner by adding the time you would otherwise be on the surface. The time can be added in 15-minute increments.

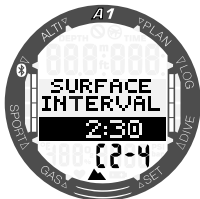

The prohibited altitude class is shown after the current elevation at the bottom line. For more information on altitude diving with the A1, see chapter 4.9 **Altitude diving**. In case the A1 is displaying the no-dive warning, the duration of the warning itself is displayed as a recommended surface interval for planning purposes (rounded up to the nearest 15-minute increment).

When the surface interval is given, or if you have no remaining desaturation left, the planner can show depth in 3m/10ft increments and scrolled by pressing +/UP or -/DOWN. The no-decompression dive time is shown for that depth. The current gas mix is shown on the bottom row.



CNS% value replaces the gas mix on the bottom left of the screen when 1% would be reached for that depth with maximum no-stop time.

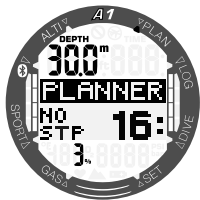

NOTE: The minimum depth for dive planning is 9m/30ft. The planner allows only depths in line with maximum ppO_2 . The oxygen content and maximum ppO_2 settings are given in the menu **GAS**.

If the MOD is shallower than 9m/30ft, planning is not allowed and the A1 will show **"MOD: LOW"**.

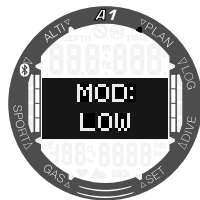

3.4.2 Decompression plan

After confirming the planned dive depth by pressing the SEL/ESC button, the dive time can be set by pressing the +/UP or -/DOWN buttons. The start point (17 minutes) is the "no decompression" time. The deepest decompression or MB-level stop is also shown as well as the Total Ascent Time.



NOTE: When the A1 is in **GAUGE** or **APNEA** modes, the Planner is disabled and this is indicated by a display like the following:

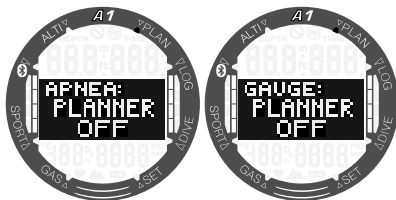

3.5 Reading the logbook

You can check your dive statistics by pressing the SEL/ESC button when in the **Logbook** menu.



On the display below, the A1 has 11 dives and total of 6 hours of diving in the Logbook, with the deepest dive at 57.0 meters and a longest dive time of 80 minutes.



By pressing the SEL/ESC button you will enter the repository of the logs where you can scroll through your dives with the +/- UP or -/DOWN buttons. The below display shows the following information: Dive number, dive mode, dive start time and date.

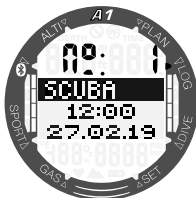

By pressing the SEL/ESC button on the above screen the A1 will display the graphical profile of the dive. This screen shows the following information: Maximum depth, total duration of the dive and the minimum temperature of the water.

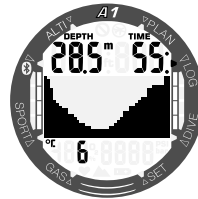

By pressing the +/UP button on the above screen the following information will appear as in the screen below:

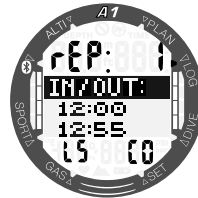

Counted repetitive dive (rep 1 is the first dive), start and finish time of the dive, microbubble level of the dive (L5) and the altitude class (C0) of the dive.

NOTE: The capacity of the A1's logbook is around 50 hours with a 4-second sampling rate.

4. DIVING WITH THE A1

The A1 is a full-featured diving computer capable of Nitrox decompression calculations, ascent rate calculations and warnings. During a dive the A1 displays information such as depth, dive time, decompression status, water temperature and much more. On the surface after a dive, remaining desaturation time, no-fly time, surface interval and prohibited altitude classes are shown in addition to the watch functions.

Note that the A1 can be set to three dive modes: SCUBA, APNEA and GAUGE. Due to the operational differences between modes, the buttons will have different functions depending on which mode you are using.

The functions of the buttons **during diving** are summarized in the table below:

“LIGHT”	Press = backlight
“SEL/ESC”	Press-and-hold in Apnea mode when in “surface interval” display = end Apnea exercise
“+/UP”	Press = scroll through alternative dive displays Press-and-hold in GAUGE mode when average depth on display = reset average depth counter Press-and-hold in GAUGE and SCUBA mode when timer on display = stop/restart the timer
“-/DOWN”	Press = scroll through alternative dive displays Press-and-hold in Apnea mode when in “surface interval” display = end Apnea exercise Press-and-hold in GAUGE and SCUBA mode when timer on display and stopped = reset timer to zero

4.1 Display information

Upon immersion, the A1 will automatically start to monitor the dive regardless of what state it was in prior to the immersion. Details on the information displayed can be found in the next sections.

Dive time: the dive time is displayed in seconds in APNEA mode and in minutes in SCUBA and GAUGE modes. If during the dive you ascend to the surface, the time spent on the surface will only be counted to the dive time if you descend again below 0.8m/3ft within 5 minutes. This allows for brief periods of orientation. While on the surface, the time will not show as progressing but it is running in the background. As soon as you submerge, the time will resume, including the time spent on the surface. If you spend more than 5 minutes at a depth shallower than 0.8m/3ft, the dive will be considered ended, it is stored in the logbook and a subsequent immersion would cause the dive time to start again from zero.

Maximum displayed time is 999 minutes. For dives longer than that, the dive time starts again from 0 minutes.

Depth: the depth is displayed in 0.1m resolution when the metric system is set. When depth is displayed in feet, the resolution is always 1 foot. Maximum operating depth is 120m/394ft.

No-stop time: calculated in real time and updated every 4 seconds. The maximum displayed no-stop time is 199 minutes.

WARNING

During all dives, perform a safety stop between 3 and 5 meters/10 and 15 feet for 3 to 5 minutes, even if no decompression stops are required.

The following chapter describes the SCUBA mode diving functions, if you are using GAUGE or APNEA dive modes, these are further described in chapters **4.11 Diving in GAUGE mode** and **4.12 Diving in APNEA mode**.

4.1.1 Dive ready mode

A press-and-hold of the -/DOWN button in the main time and date display will give you access to the dive ready mode which shows you your current dive settings. Information like dive mode, MB-level, water type selection, MOD and gas oxygen content will be displayed as follows:

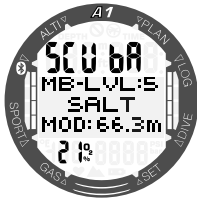

After a dive there are further displays which can be shown by pressing the +/UP button. These displays can identify for example the no-dive time (10h), no-fly time (2h), surface interval (0:06), repetitive dive number (1) and current & prohibited altitude classes (0 & 3).

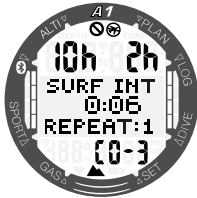

By a further press of the -/DOWN button the no-dive time (10h), no-fly time (2h), and remaining desaturation time (13:50) will be shown.



4.1.2 Display configuration during the dive

Throughout the dive, the A1 displays depth and dive time always at the top of the screen. Gas mix and the water temperature are shown at the bottom row. The information in the middle of the screen changes and it is also selectable by pressing the +/UP or -/DOWN buttons.

4.1.2.1 SCUBA mode display selection

In SCUBA mode you can choose from two display versions while diving: Light or Classic. The following screens illustrate the information in the middle of the screen which can be selected as shown in the sections below.

NOTE: The default information in the middle of the screen at the beginning of the dive is the No-Stop Time. If you select another information in the middle of the screen, there is no timeout to the default except when decompression limit is reached. Decompression time and depth are appearing in the middle of the screen after 3 minutes from any other selected screen.

4.1.2.1.1 Light version



No-Stop Time, which is the time at current depth before decompression stops are required.



Current depth is shown in feet or full meters without a comma. This is the larger duplicate of the top row depth.



Elapsed Dive Time, this is a larger duplicate of the top row dive time.



Total Ascent Time, which is the time to the surface with optimal ascent speed including the possible stops.



Gas Oxygen Content, this is a larger duplicate of the bottom row O₂% value.

4.1.2.1.2 Classic version



No-Stop Time



Decompression stop



No-Stop Time with MB-level 0

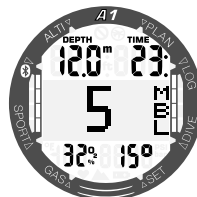

Current MB-level



Current time of the day



Timer



Maximum depth reached during current dive

4.1.2.2 GAUGE mode display selection

In GAUGE mode you can choose from two display versions while diving: Light or Classic. The following screens illustrate the information in the middle of the screen which can be selected as shown in the sections below.

NOTE: When the A1 is set to GAUGE mode, it will only monitor depth, time, and temperature, and it will not carry out any decompression calculations. Due to this there are fewer alternative displays to scroll through.

4.1.2.2.1 Light version



Timer



Current depth



Elapsed dive time



Average depth

NOTE: The average depth can be reset by a press-and-hold of the +/UP button when it is active on the screen.

4.1.2.2.2 Classic version

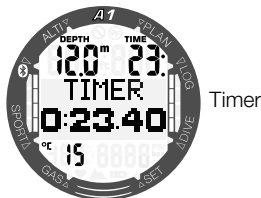

Timer

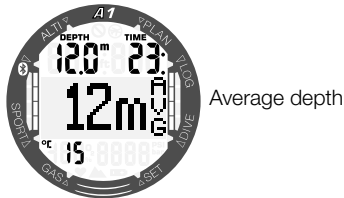

Average depth

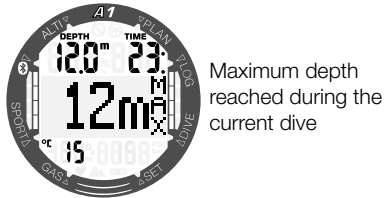

Maximum depth reached during the current dive



Current time of the day

 **NOTE:** In GAUGE and SCUBA mode when the timer is displayed, it can be stopped by a press-and-hold of the +/UP button. A repeated press-and-hold of the +/UP button will restart the timer. When the timer is stopped, it can be reset to zero by pressing-and-holding the -/DOWN button.

4.1.2.3 APNEA mode

If the APNEA mode is triggered manually by a press-and-hold of the -/DOWN button, the surface interval starts counting in the middle of the display without a previous dive information (depth is --- at top row and repetitive dive count is 0 at bottom row) as in the screen below.

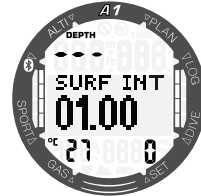

However, after an immersion the surface screen shows the last max depth, surface interval, water temperature and amount of repetitive dives during the APNEA session. By pressing the +/UP button the total time of this APNEA dive session is shown.

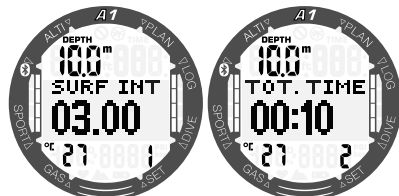

A further press of the +/UP button will alternatively show the last dive depth and duration in the middle part of the screen.

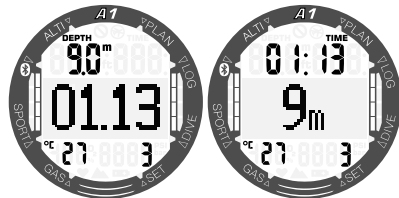

During the Apnea dive these two screens show the current dive depth and duration and they can be scrolled through by pressing the +/UP or -/DOWN buttons.

NOTE: The dive depth displayed in large size in the middle part of the screen is shown with no decimal values rounded up or down, but the actual depth is always precisely saved and shown in the logbook with 0.1m/1ft accuracy.

4.2 Safety stop timer

If a minimum depth of 10m/30ft is reached during the dive, at a depth of 5m/15ft the safety stop timer will automatically start a 3-minute countdown. If you go below 6.5m/20ft, the timer will disappear and the no-stop time will be shown again. Upon returning to 5m/15ft, the timer will start again automatically.



4.3 Activating the backlight

To activate the backlight, press the LIGHT button. For setting the duration of the backlight refer to chapter 3.1.1.1 **Backlight**.

NOTE: The backlight is not available when the CHANGE BATTERY warning appears.

4.4 Alarms and warnings during diving

The A1 can alert you to potentially dangerous situations via warnings and alarms. You can modify the warning and alarm settings in the menus or via the LogTRAK interface.

General warnings and alarms are shown in inverted text (white with black background) in the middle of the display. Additionally, audible signals are available when the sound function is enabled. Warnings are shown for 12 seconds or they can be confirmed by pressing the SEL/ESC button which changes the alarm display back to the normal dive display. However, if the warning condition continues, the warning can be recalled by scrolling with the +/UP or -/DOWN buttons. Alarms can also be confirmed by pressing the SEL/ESC button, but they remain on the alternate display which can be scrolled through with the +/UP or -/DOWN buttons.

WARNING

When the A1's buzzer is disabled all audible alarms and warnings are muted but will still appear on the display if triggered.

4.4.1 Maximum depth warning

If you have enabled the maximum depth warning, the below display will be shown when the selected depth is reached. Refer to chapter 3.2.4.2 **Dive depth warning** for setting this warning.



4.4.2 MOD (ppO₂) alarm

If you exceed the maximum partial pressure of the selected gas, the following alarm is shown: MOD + DEPTH. The alarm remains active until you ascend to depth where ppO₂ is within safe limits.

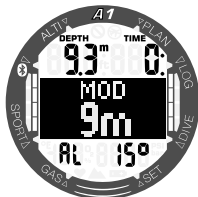

⚠ WARNING

The MOD should not be exceeded. Disregarding the alarm can lead to oxygen poisoning. Exceeding a ppO₂ of 1.6bar can lead to sudden convulsions resulting in serious injury or fatal issue.

4.4.3 Dive time warning

If you have enabled the dive time warning, this will be shown when the selected time is reached. Refer to chapter 3.2.4.1 **Dive time warning** for setting this warning.



4.4.4 Turning time

When dive time warning is activated the A1 will alert you when it's time to turn around and start ascending to the surface.

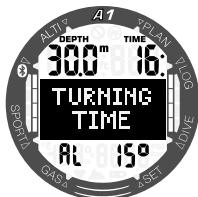

4.4.5 No-stop time = 2 minute warning

If you wish to avoid unintentionally performing a decompression dive, the A1 can activate a warning when the no-stop time reaches 2 minutes. This applies to both LO no-stop and MB no-stop time (see chapter:4.6 for more information on MB level diving). It gives you the opportunity to start ascending before incurring a decompression stop or a level stop obligation.



4.4.6 No-stop time warning

The A1 can activate a warning when the first mandatory decompression stop appears. This alerts you to the fact that a direct ascent to the surface is no longer possible.

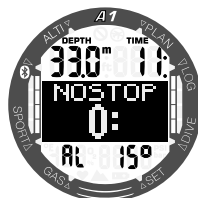

4.4.7 CNS O₂ warning (over 75%)

The A1 tracks your oxygen uptake via the CNS O₂ clock. If the calculated value of CNS O₂ reaches 75%, the A1 will emit a sequence of audible beeps for 12 seconds and the following display will be shown.

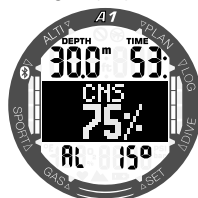

4.4.8 CNS O₂ alarm (100%)

The A1 tracks your oxygen uptake via the CNS O₂ clock. If the calculated value of CNS O₂ reaches 100%, the A1 will emit a sequence of audible beeps for 12 seconds and the CNS 100% alarm will be shown.

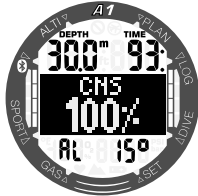

⚠ WARNING

When the CNS O₂ reaches 100% there is danger of oxygen toxicity. Start the procedure to terminate the dive.

4.4.9 L0 no-stop time = 2 minute warning

When diving with an MB level higher than L0, the underlying L0 information is not directly visible on the display (though it is accessible as alternate information). You can choose to have your A1 warn you when the underlying L0 no-stop time reaches 2 minutes while diving with an active MB level higher than L0.



4.4.10 Entering decompression warning

The A1 can activate a warning when the first mandatory decompression stop appears. This alerts the diver to the fact that a direct ascent to the surface is no longer possible. This warning applies to dives with the computer set to L0-L5.



4.4.11 Missed decompression stop alarm

If in the presence of a required decompression stop you ascend more than 0.5m/2ft above the required stop, the A1 will indicate an alarm: **MISSED DECO**. This will continue for as long as you stay 0.5m/2ft or more above the required stop.



⚠ WARNING

Violating a mandatory decompression obligation may result in serious injury or fatal issue.

4.4.12 MB level stop ignored

When diving with an MB level higher than L0 and in the presence of MB level stops, the A1 can warn you if you reach a depth shallower than the deepest required MB level stop, therefore allowing you to avoid missing the required stop.

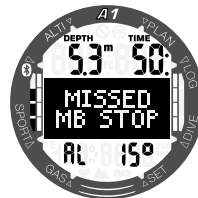

4.4.13 MB level reduction warning

When diving with an MB level higher than L0 and in the presence of MB level stops, if you ascend more than 1.5m/5ft above the deepest required MB level stop, the A1 reduces your MB level to the next possible

level. The display will show the new active MB level. You can set your A1 to warn you when this happens.



4.4.14 Ascent rate alarm

The A1 employs a variable ideal ascent rate. Its value ranges from 3 to 10m/min (10 to 33ft/min) and the actual breakdown by depth range is listed in the table below.

DEPTH		ASC SPEED	
m	ft	m/min	ft/min
0	0	3	10
2.5	8	5.5	18
6	20	7	23
12	40	7.7	25
18	60	8.2	27
23	75	8.6	28
31	101	8.9	29
35	115	9.1	30
39	128	9.4	31
44	144	9.6	32
50	164	9.8	32
120	394	10	33

If you ascend too quickly, the resulting pressure reduction could lead to microbubble formation. If you ascend too slowly, the continued exposure to high ambient pressure means you will continue loading some or all of your tissues with nitrogen.

If the ascent rate is greater than 110% of the ideal value, the SLOW DOWN alarm is shown.



4.4.15 SOS

If you stay above a depth of 0.8m/3ft for more than 3 minutes without observing a mandatory decompression stop, the A1 will switch into SOS mode. Once in SOS mode the A1 will lock up and will be inoperable as a dive computer for 24 hours. If it is used for diving within the 24 hours of an SOS lock, it will automatically switch to gauge mode and provide no decompression information.

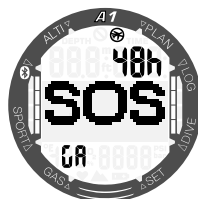

SOS in Gauge mode



SOS in Scuba mode

⚠ WARNING

Violating a mandatory decompression obligation may result in serious injury or fatal issue. Serious injury or fatal issue may result if a diver does not seek immediate treatment should any signs or symptoms of decompression sickness occur after a dive.

Do not dive to treat symptoms of decompression sickness.

Do not dive when the computer is in SOS mode.

4.4.16 Low battery alarm

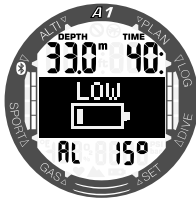

During the dive A1 will alert you if the battery level is getting critically low. This means you need to start the procedure to terminate the dive, as there is not enough energy in the battery to ensure the proper functions and the computer may fail. Some functions like backlight and audible alarms are no longer available.

WARNING

Do not start a dive if the battery symbol is blinking on the watch mode. The computer may fail to function during the dive and this could lead to serious injury or fatal issue.

4.5 No-Dive warning

If the A1 detects a situation of increased risk (due to potential microbubble accumulation from previous dives or a CNS O₂ level above 40%), the **NO DIVE** symbol will appear to advise you against performing another dive right away. The suggested time interval that you should wait prior to diving again is shown in the top left section of the dive mode display.

You should not undertake a dive as long as the no-dive warning is displayed on the computer screen. If the warning is prompted by microbubble accumulation (as opposed to CNS O₂ over 40%) and you dive anyway, you will have shorter no-stop times or longer decompression times. Moreover, the duration of the microbubble warning at the end of the dive can increase considerably.

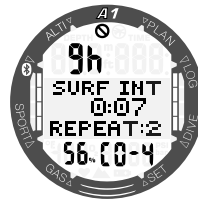

4.6 No-Fly time

The no-fly time is the time during which an exposure to the reduced pressure (equal to ascending at higher altitudes) inside the cabin of an airplane could cause decompression sickness, as calculated by the decompression model in the computer. The no-fly symbol with countdown timer is shown in the top right section of the display until the restriction is completed.

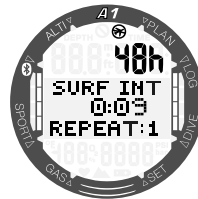

4.7 Diving with MB-levels

Microbubbles are tiny bubbles that can build up inside a diver's body during a dive and normally dissipate naturally during an ascent and on the surface after a dive. Dives within no-stop times or the observance of decompression stops do not prevent the formation of microbubbles in the venous blood circulation.

Dangerous microbubbles are those migrating into the arterial circulation. The reasons for the migration from the venous blood circulation to the arterial circulation can be because of a build-up of microbubbles collecting in the lungs. SCUBAPRO has equipped the A1 with technology to help protect divers from these microbubbles.

With the A1 you can choose – according to your specific needs – a MB-level that will provide a level of protection from microbubbles. Diving with MB-levels includes additional ascent stops which slow the ascent process, giving the body more time to desaturate. This works contrary to the formation of microbubbles and may increase safety.

The A1 features 6 microbubble levels (L0-L5). Level L0 corresponds to SCUBAPRO's well-known decompression model ZH-L16 ADT and does not require additional stops due to microbubble formation. Levels L1 to L5 offer additional protection from microbubble formation, with level L5 offering the highest level and most protection.

Similar to the display of information during decompression dives or dives within no-stop time, the A1 displays the depth and duration of the first level stop as well as the total time of ascent as soon as the MB no-stop time has run out. As the MB no-stop time is shorter than the ordinary no-stop time, you will be required to perform a stop sooner than a diver using level L0.

If you ignore a required stop, the A1 will simply step down to a lower MB-level. In other words, if you choose level L4 prior to the dive, and during the dive you ignore the L4's recommended stops, the A1 will

automatically adjust the setting to level L3 or lower.

Comparison of dives with MB level L0 and level L5

When two A1 dive computers are used simultaneously, with one unit set to a MB-level of L5 and the other to a MB-level of L0, the no-stop time for the L5 unit will be shortened and more stops will be required before the L5 diver has the same obligation of a decompression stop as the L0 diver. These additional stops help dissipate microbubbles.

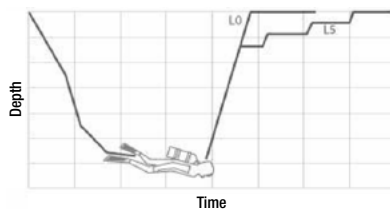

4.8 PDIS (Profile Dependent Intermediate Stop)

4.8.1 Introduction to PDIS

The main purpose of a dive computer is to track your nitrogen uptake and recommend a safe ascent procedure. Diving within the so-called no-stop limits means that at the end of the dive you can ascend directly to the surface, albeit at a safe ascent rate, while for dives outside of the no-stop limit (so-called decompression dives), you must perform stops at certain depths and allow time for excess nitrogen to be expelled from your body before finishing the dive and re-surfacing.

In both cases, it can be beneficial to stop for a few minutes at an intermediate depth between the maximum attained depth during the dive and the surface or, in case of a decompression dive, the first (deepest) decompression stop.

An intermediate stop of this kind is beneficial as soon as the ambient pressure at that depth is low enough to ensure that your body is predominantly off-gassing nitrogen, even if under a very small pressure gradient. In such a situation, you can still cruise along the reef and enjoy the dive while your body gets a chance to slowly release nitrogen.

In recent times, so-called “deep” stops have been introduced in some dive computers and tables, defined as half the distance from the dive’s maximum depth and the surface (or the lowest decompression stop). Spending 2 or 15 minutes at 30m/100ft would result in the same deep stop at 15m/50ft.

With PDIS, as the name suggests, the A1 interprets your dive profile and suggests an intermediate stop that is a function of your nitrogen uptake so far. The PDI stop will therefore change over the course of the dive to reflect the continuously changing situation in your body. Along the same lines, PDIS will account for the accumulated nitrogen from previous dives; hence, PDIS is also repetitive-dive dependent. Conventional deep stops completely ignore these facts.

The following figure quantifies the extent of PDIS and illustrates its dependence on cumulative nitrogen uptake for 2 sample dive profiles. This figure also demonstrates the conceptual difference between PDIS and the rather rudimentary “deep” stops. Specifically, the figure compares 2 dive

profiles to a maximum depth of 40m/132ft that are otherwise very different.

Profile 1 stays at 40m/132ft for 7 minutes, then ascends to 30m/100ft for 3 minutes, followed by 12 minutes at 20m/65ft. Profile 2 stays less than 2 minutes at 40m/132ft, then ascends to 21m/69ft and stays there for 33 minutes. Both dive profiles are no-stop dives to the limit of entering decompression.

The solid line represents the PDIS depth as displayed on the computer screen during the course of the dive for profile 1, the broken line represents the PDIS depth as displayed on the computer screen during the course of profile 2. One can see that the displayed PDIS depth increases as more nitrogen is accumulated in the body, but does so very differently in the 2 dives due to the different exposure in the 2 profiles. The PDI stop is carried out at 25 minutes for profile 1 and at 37 minutes for profile 2, followed by the safety stop at 5m/15ft.

The line made up of small solid dots, on the other hand, represents the depth that would be displayed by a computer following the conventional deep stop method, and it would be the same for the 2 dive profiles. Deep stops completely ignore any facts about the dives themselves aside from max depth.

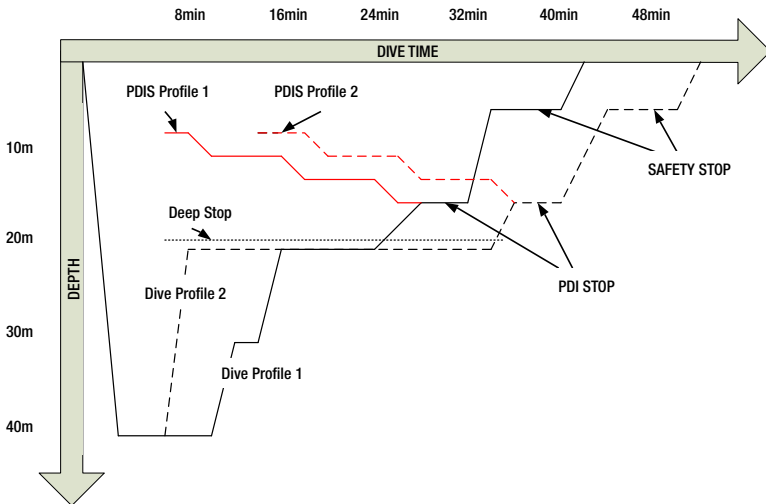

4.8.2 How does PDIS work?

The mathematical decompression model in the A1, called ZH-L16 ADT MB, tracks your decompression status by dividing your body into 16 so-called compartments and mathematically following the uptake and release of nitrogen in each with the appropriate laws of physics. The various compartments simulate parts of your body such as central nervous system, muscles, bones, skin and so on.

The depth of the PDI stop is calculated as that at which the leading compartment for the decompression calculation switches from on-gassing to off-gassing, and the diver is advised to perform a 2-minute stop above the displayed depth (this is the opposite of a decompression stop, where you are asked to remain just beneath the displayed depth). During this intermediate stop, the body is not taking up any more nitrogen in the leading compartment, but rather releasing nitrogen (though under a very small pressure gradient). This, combined with the relatively high ambient pressure, inhibits bubble growth. It should be noted that the 4 fastest compartments, up to 10-minute half-times, respectively, are not considered for the determination of the PDI stop depth. This is due to the fact that these compartments are only “leading” for

very short dives, for which an intermediate stop is not required at all.

 **NOTE:** The PDI stop is not a mandatory stop, and it is NOT a substitute for the 3- to 5-minute safety stop at 5m/15ft.

WARNING

Even when performing a PDI stop, you still **MUST** perform a safety stop at 5m/15ft for 3 to 5 minutes. Performing a 3- to 5-minute stop at 5m/15ft at the end of any dive remains the best thing you can do for yourself.

4.8.3 Diving with PDIS

When the calculated PDI stop is deeper than 8m/25ft, the A1 shows it on the display and continues to do so until you reach the displayed depth during an ascent. The displayed value changes during the dive as the A1 tracks the uptake of nitrogen in the 16 compartments and updates the PDIS depth accordingly to reflect the optimum at all times.

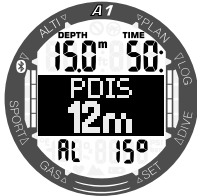

During a no-stop dive, as soon as you reach that depth during an ascent, a 2-minute countdown will appear.



You can have one of these 3 situations:

- You have spent 2 minutes within 3m/10ft above the indicated depth. The countdown timer disappears and you have successfully completed the PDIS.
- You have descended more than 0.5m/2ft below the PDIS. The countdown timer disappears and will reappear again, starting at 2 minutes, the next time you ascend to the PDIS depth.
- You have ascended more than 3m/10ft above the PDIS. The PDIS value and countdown timer disappears and PDIS has not been performed.

NOTE: The A1 issues no warnings relating to a missed PDI stop. When diving with MB levels, PDIS follows the same rules as described above. MB levels, however, introduce stops earlier and deeper than the L0 base algorithm. As such, the PDIS display may be delayed and, for certain dives, it may not be displayed at all. This, for example, would be the case for a shallow dive with air (21% oxygen) and a MB level L5.

4.9 Altitude diving

4.9.1 Altitude warning after a dive

Climbing to altitude is similar to starting an ascent from a dive: you expose your body to a lower partial pressure of nitrogen and you start off-gassing. After a dive, given the higher nitrogen loading in your body, even reaching an otherwise negligible altitude can potentially cause decompression sickness. Consequently, the A1 constantly monitors the ambient pressure and uses it to evaluate your nitrogen loading and off-gassing. If the A1 notices a drop in ambient pressure not compatible with your current nitrogen loading, it will activate a warning (altitude symbol starts blinking) to alert you of a potentially dangerous situation.

The A1 counts down remaining saturation and indicates this on the Surface screen with the no-fly time until the available saturation is no longer dangerous during a flight or when crossing over a mountain pass.

The allowable altitude (beyond which the A1 has computed to be incompatible with your current nitrogen saturation levels) is displayed above the no-fly time. Refer to chapter **2.3 Reading the altitude, barometric and temperature values** for more information.

4.9.2 Altitude and the decompression algorithm

Atmospheric pressure is a function of altitude and weather conditions. This is an important aspect to consider for diving, because the surrounding atmospheric pressure has an influence on on-gassing and off-gassing of nitrogen in your body. The A1 divides the possible altitude range into 5 classes that are illustrated in the picture below:

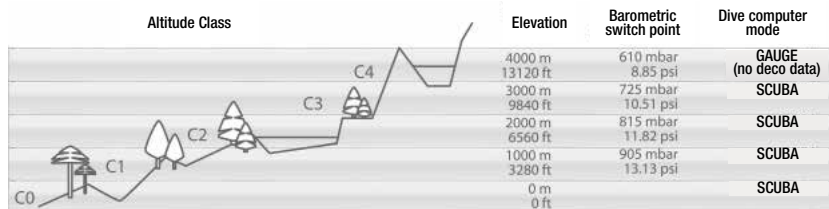

The altitude classes are approximate elevations because the effect of weather conditions can make the switch point pressure occur at different levels.

⚠ WARNING

At the altitude class 4 or higher the A1 operates in GAUGE mode only (the mode will switch automatically).

👉 *NOTE:* You can check your current altitude class and elevation in the **Altimtr** menu.

👉 *NOTE:* The A1 deals with altitude automatically: it monitors the atmospheric pressure every 60 seconds and if it detects a sufficient drop in pressure, it does the following: it indicates the new altitude range and, if applicable, the prohibited altitude range; it indicates the desaturation time, which in this case is an adaptation time to the new ambient pressure. If a dive is started during this adaptation time, the A1 considers it a repetitive dive since the body has residual nitrogen.

👉 *NOTE:* A fast descent from mountains or a fast rise in airplane cabin pressure may activate the dive mode. The A1 will automatically detect and end this "dive" after 12 hours, or you may manually activate the check by a press-and-hold of both +/UP and -/DOWN buttons at the same time. This kind of false dive will not be stored in the A1 logbook.

4.9.3 Prohibited altitude

Going to altitude, as well as flying after diving, exposes your body to a reduced ambient pressure. In a manner similar to no-fly time, the A1 advises you of the safe altitudes you can reach after a dive, and those which are not safe. If you have to drive over a mountain pass to return home after a dive, this information can be quite important and you can check this information in the planner.

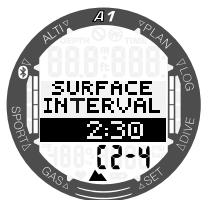

The current altitude class is shown on the left on the bottom row and the prohibited altitude is shown on the right. In the example above, the diver is presently at altitude class 2 and should not reach altitudes above 4000m (class 4) within the given interval of 2 hours and 30 minutes. By increasing the interval time on the middle row the allowed altitude increases due to the desaturation caused by the time spent at the current altitude class.

⚠ WARNING

If atmospheric pressure is below 610mbar (altitude higher than 4000m/13300ft), no decompression calculation is carried out by the A1, and it will not start in SCUBA mode, but in GAUGE mode. In addition, the dive planner is not available at this altitude.

4.9.4 Decompression dives in mountain lakes

In order to ensure optimal decompression even at higher altitudes, the 3m/10ft decompression stage is divided into a 2m/7ft stage and a 4m/13ft stage in altitude ranges 1, 2 and 3.

If atmospheric pressure is below 610mbar (altitude higher than 4000m/13300ft), no decompression calculation is carried out by the A1 (automatic GAUGE mode). In addition, the dive planner is not available in this altitude class.

4.10 Diving with Nitrox

Nitrox is the term used to describe breathing gases made of oxygen-nitrogen mixes with the oxygen percentage higher than 21% (air). Because nitrox contains less nitrogen than air, there is less nitrogen loading on the diver's body at the same depth as compared to breathing air.

However, the increase in oxygen concentration in nitrox implies an increase in oxygen partial pressure in the breathing mix at the same depth. At higher than atmospheric partial pressures, oxygen can have toxic effects on the human body. These can be grouped into 2 categories:

1. Sudden effects due to oxygen partial pressure over 1.4bar. These are not related to the length of the exposure to high oxygen partial pressure. Sudden effects can vary and depend on the exact level of partial pressure they happen at. It is commonly accepted that partial pressures up to 1.4bar are tolerable during the active part of the dive, and maximum oxygen partial pressures up to 1.6bar during the decompression.
2. Long exposure effects to oxygen partial pressures over 0.5bar due to repeated and/or long dives. These can affect the central nervous system and cause damage to lungs or to other vital organs. Long exposures can be divided between more severe Central Nervous System effects and less dangerous long-term Pulmonary Toxicity effects. The A1 treats high ppO₂ and long exposure effects in the following ways:

Against sudden effects: The A1 has an MOD alarm set for a user-defined ppO₂max. As you enter the oxygen concentration for the dive, the A1 shows you the corresponding MOD for the defined ppO₂max. The default value of ppO₂max from the factory is 1.4bar. This can be adjusted to your preference between 1.0 and 1.6bar. It can also be turned off. Please refer to chapter: **3.3.1 Setting gas oxygen content** for more information on how to change this setting.

Against long exposure effects: The A1 “tracks” the exposure by means of the CNS O₂ clock. At levels of 100% and higher there is risk of long exposure effects, and consequently the A1 will activate an alarm when this level of CNS O₂ is reached. The A1 can also warn you when the CNS O₂ level reaches 75%. Note that the CNS O₂ clock is independent of the value of ppO₂max set by the user. CNS O₂ 75% warning and CNS O₂ 100% alarm can be activate during a dive (see chapters **4.4.7 CNS O₂ warning (over 75%)** and **4.4.8 CNS O₂ alarm (100%)** for more information), whereas the remaining CNS O₂ value after a dive is shown in the “ready to dive” display in the left side of the bottom row (in the below display this is 56%).



The CNS O₂ clock increases when the oxygen partial pressure is higher than 0.5bar, and decreases when the oxygen partial pressure is lower than 0.5bar. Hence, while on the surface breathing air you will always be decreasing the CNS O₂ clock. During the dive, the depth at which 0.5bar is reached for various mixes is as follows:

Air: 13m/43ft

32% O₂: 6m/20ft

36% O₂: 4m/13ft

 **NOTE:** For oxygen concentrations of 80% and higher, the ppO₂max is fixed at 1.6bar and cannot be changed.

Against long exposure and repetitive dives: Repetitive diving and very long exposures (technical and rebreather diving) with high ppO₂ may cause long term pulmonary toxicity effects that can be tracked with OTUs. If you exceed your OTUs for the dive, a warning will be shown.

4.11 Diving in GAUGE mode

When the A1 is set to GAUGE mode, it will only monitor depth, time, and temperature, and will not carry out any decompression calculations. You can only switch to GAUGE mode if the computer is completely desaturated. All audible and visual warnings and alarms, other than the low battery, max depth and max dive time, are turned off.

WARNING

Dives in GAUGE mode are performed at your own risk. After a dive in GAUGE mode you must wait at least 48 hours before diving using a decompression computer.

When on the surface in GAUGE mode, the A1 will show neither the remaining desaturation time nor the CNS O₂% value. It will, however, display a surface interval up to 48 hours and a 48-hour no-fly time. This no-fly time is also the time during which you cannot change the dive mode.

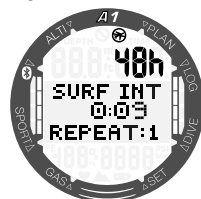

The GAUGE mode surface display after a dive shows the dive time in the top row. In the middle row the timer is running from the dive start or last manual restart. In the bottom row the water temperature is shown. After a 5-minute timeout the display changes to GAUGE mode ready to dive menu.

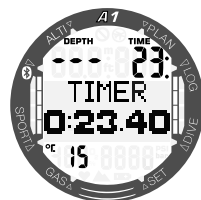

During a dive in GAUGE mode, the A1 displays depth and dive time at the top row, a timer in the middle and water temperature

at the bottom row. The timer can be paused and restarted by press-and-hold the +/UP button. When the timer is paused, it can be reset to zero by pressing-and-holding the -/DOWN button. The alternative displays in the middle can be scrolled through by pressing the +/UP or -/DOWN buttons.



NOTE: For more information about the configuration of the dive displays in GAUGE mode, please refer to chapter 4.1.2.2 GAUGE mode display selection.

4.12 Diving in APNEA mode

The A1 measures the depth in APNEA mode every 0.25 seconds to ensure the precise maximum depth. In the logbook the data is saved in 1-second intervals. In APNEA mode it is also possible to start and stop the dive manually with a press-and-hold of the -/DOWN button. This way you can use the A1 for static Apnea dives, where a normal dive start depth of 0.8 meters will not start a new dive.

Apnea mode at the surface after an immersion shows the maximum depth, water temperature and the amount of repetitive dives. The surface interval is counted in the middle of the screen.

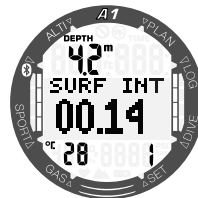

By pressing the -/DOWN button from the surface interval display, the maximum depth (4m) and duration (01.13 min) of the last dive and the total duration of the current Apnea exercise (00:04) are shown.

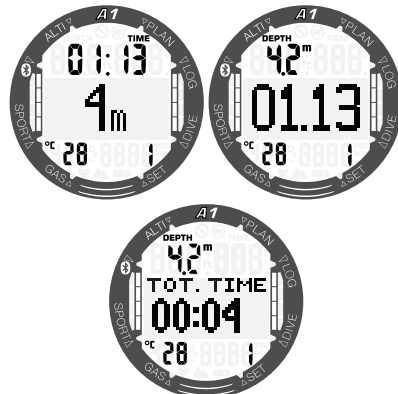

The displays during the dive in Apnea mode show the current dive time, depth, water temperature and number of repetitive dives of the current session.



The alternative displays in APNEA mode can be scrolled by pressing the +/UP or -/DOWN buttons and this changes the dive time to the middle of the display as shown below.

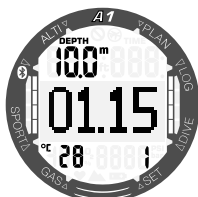

As with Gauge mode, the A1 in Apnea mode doesn't carry out any decompression calculations. You can only switch to APNEA mode if the computer is completely desaturated. Also the A1 is locked in the APNEA mode for 12 hours after shallower than 5m dives and after deeper dives the lock period is 24 hours.

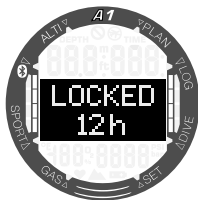

5. INTERFACES FOR THE A1 AND AN INTRODUCTION TO LOGTRAK

5.1 Establishing Bluetooth communication

The A1 can be connected via Bluetooth to a desktop, laptop or handheld device for downloading dive data, configuring dive computer settings or uploading firmware updates.

From the main menu, toggle down to **Bluetooth** using the +/UP or -/DOWN buttons. Press the SEL/ESC button.

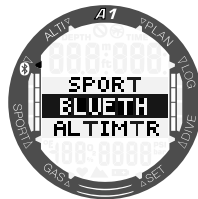

At this point the A1 is ready for Bluetooth communication. Bluetooth is active only when this screen is displayed.

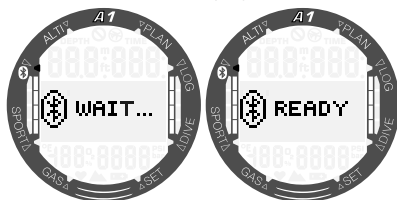

To achieve Bluetooth communication with another device, set the device you want your A1 to communicate with (e.g. an iOS or Android handheld device) to "scanning" mode.

The first time you do this will require entering a pin code to ensure secure communication. This pin code is shown on the A1's screen.

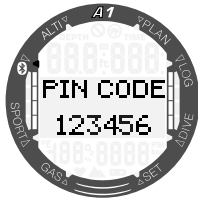

Once the code is accepted by the device you want to connect to, the link is ready for communication.

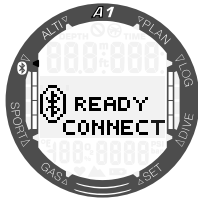

5.2 LogTRAK

LogTRAK is the software that allows the A1 to communicate with various operating systems. LogTRAK is available for Windows, Mac, Android and iOS. In the following section, Windows and Mac versions of LogTRAK are represented. Android and iPhone/iPad versions of LogTRAK operate similarly but do not have all of the features offered in the PC/Mac versions.

5.2.1 Connecting the A1 with LogTRAK

To start the communication using Bluetooth:

1. Pair the A1 with the device where LogTRAK is running.
2. Launch LogTRAK.
3. Check that the A1 is detected by LogTRAK.

Extras -> Options -> Download:

Choose “Bluetooth Low Energy” option.

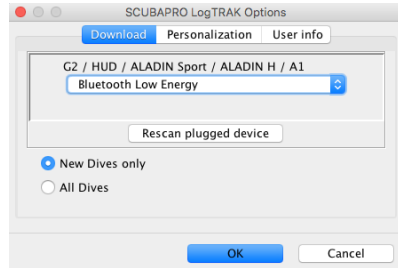

NOTE: The A1 has a timeout of 5 minutes for a non-active Bluetooth connection. After this interval the A1 will disable Bluetooth and return to time and date mode.

NOTE: Desktop PCs need a generic Bluetooth Low Energy (4.0) dongle, if there is no build in Bluetooth 4.0 or newer module. Windows version below 8.0 and Mac computers require an external Bluegiga BLED Bluetooth dongle.

5.2.2 Download dive profiles

From LogTRAK, by selecting **Dive -> Download Dives** you can transfer the A1 Logbook to your PC/Mac.

There are 3 main views, each showing a specific part of your dive logs:

1. Profile, showing the graphical data of the dive.
2. Details about the dive, where you can edit, for example, the equipment information.
3. Location, which shows your dive site on the world map.

The selection tabs for views are found along the left side of the main window.

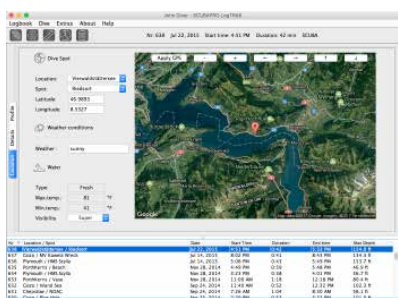
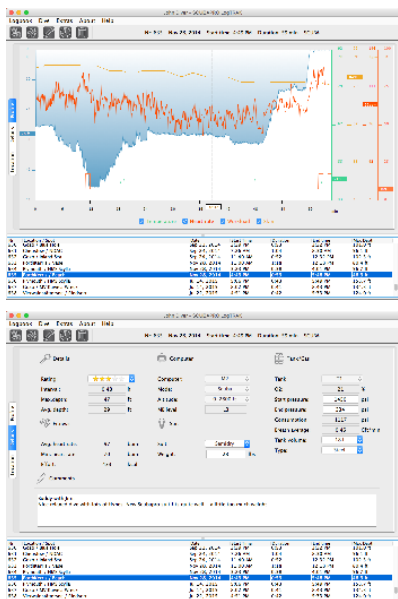

5.2.3 Reading computer information

By selecting **Extras -> Read dive computer settings**, you can find general device information for your A1. Dive warnings can be enabled or disabled in this menu by ticking the boxes found on the left section of the “Warning audible” window.

By ticking the box “use PC-Time” and selecting “Write” you can easily update your current time and date.

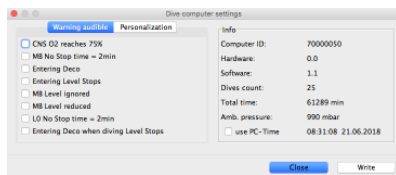

5.2.4 Writing owner information with LogTRAK

Owner information can be registered in the **Extras -> Read dive computer settings-> Personalization** section.

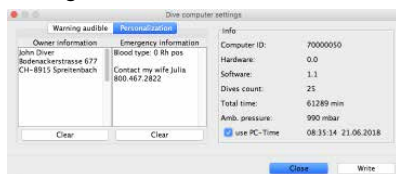

5.2.5 Setting units in LogTRAK

You can set your choice of units in your A1 or on your PC by using the following LogTRAK personalization section:

Extras-> Options-> Personalization

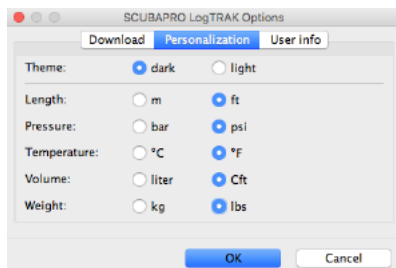

Basic personal details about the user can be shared in the **Extras-> Options-> User info** section.

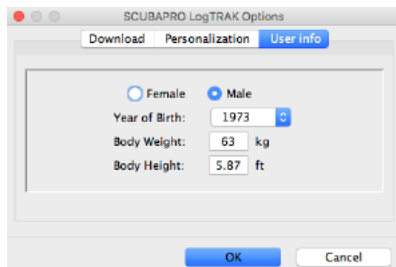

5.2.6 Updating your A1

In order to update the operating software on your A1 dive computer, you need to download the latest software package for your A1 from the SCUBAPRO website and store the .swu file locally.

To perform the software update, select the menu **Firmware upload** from LogTRAK. A file selecting pop-up window will appear. Select the location where you have stored the .swu file

NOTE: A1 will check the battery status before the update process. If the battery level is too low, the software update cannot be started. In order to update your A1, the battery must be replaced first.

Once the Bluetooth connection was established and the new software version has been selected, the transfer will start. The A1 shows the transfer status on the display with a progress bar.

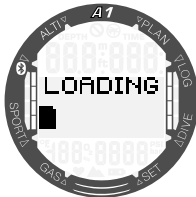

After successful software download the A1 starts the reprogramming automatically.

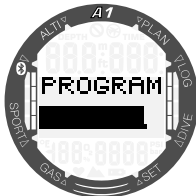

Once the new software has been programmed, the A1 will complete a few internal checks and perform a reboot.

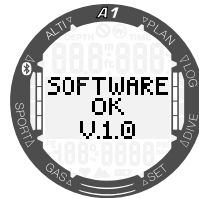

After a successful update the A1 will display the message "Software OK". This message can be cleared by a short press of the SEL/ESC button. After this your A1 is again ready for normal use.

NOTE: If the A1 detects any problem during the transfer, programming or software checks, an error message will appear on the display. In case of an error, switch off other Bluetooth or WLAN devices from nearby and bring your A1 closer to the transmitting device. In case of reoccurring error, check the SCUBAPRO website or contact your local SCUBAPRO service center.

You can check the current software version of your A1 in the menu **Settings -> User -> Service**. For checking the last service date press the +/UP button and the following screen will be displayed:

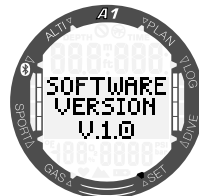

NOTE: LogTRAK doesn't have a firmware upload module in all operating systems, in Android this function looks like in the screenshot below.

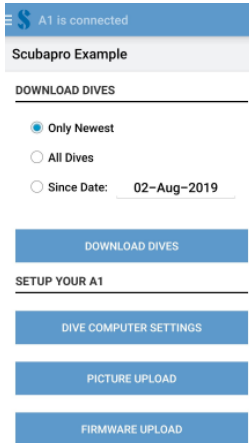

6. TAKING CARE OF YOUR A1

6.1 Changing the watch strap

The watch straps of the A1 can be removed and replaced by unscrewing the Torx screws at the corners of the watch body.



Different types of watch strap are available, like the nylon NATO type strap, linked metal strap and swiveled silicon strap.

6.2 Display protection foil

You can protect your A1's glass face with a SCUBAPRO display guard. This foil can be easily replaced if damaged.



NOTE: If air bubbles get stuck underneath the protection foil when placing it on your A1's glass face, do not try to remove them as the water pressure will eliminate them after the first dive.

6.3 Technical information

Operating altitude:

Sea level to approximately
4000m/13300ft.

Max operating depth:

120m/394ft; resolution is 0.1m until
99.9m, and 1m at depths deeper than
100m. Resolution in feet is always 1ft.
Accuracy complies with EN13319 and
ISO 6425.

Decompression calculation range:

0.8m to 120m / 3ft to 394ft.

Clock:

Quartz clock; time, date, dive time
displays up to 99 minutes and 59
seconds, and in minute steps up to
999 minutes.

Oxygen concentration:

Adjustable between 21% and 100%.

Operating temperature:

-10C to +50C / 14F to 122F.

Power supply:

Lithium type CR2450 battery.

Operation time with a fresh battery:

Up to 2 years. Actual battery operation
time depends primarily on the
operational temperature and backlight
settings, but also on many other
factors.

Bluetooth® transceiver:

Operating frequency 2402-2478 MHz,
max power < 3 dBm, connection
range approx. 2m.

6.4 Maintenance

The A1's depth accuracy should be verified every 2 years by an authorized SCUBAPRO dealer. The last service date can be checked from the menu: **Settings -> User -> Service.**

Aside from that, the A1 is virtually maintenance-free. All you need to do is rinse it carefully with fresh water after each dive and change the battery when needed. To avoid possible problems with your A1, the following recommendations will help assure years of trouble-free service:

- Avoid dropping or jarring your A1.
- Do not expose your A1 to intense, direct sunlight.
- Do not store your A1 in a sealed container; always ensure free ventilation.
- If there are problems with the water contacts, use soapy water to clean your A1 and dry it thoroughly.
- Do not use silicone grease on the water contacts!
- Do not clean your A1 with liquids containing solvents.
- Check the battery capacity before each dive.
- If the battery warning appears, replace the battery.
- If any error message appears on the display, take your A1 back to an authorized SCUBAPRO dealer.

6.5 Warranty

The A1 has a 2-year warranty covering defects in workmanship and functioning. The warranty only covers dive computers which have been bought from an authorized SCUBAPRO dealer. Repairs or replacements during the warranty period do not extend beyond the warranty period itself.

Excluded from warranty coverage are faults or defects due to:

1. Excessive wear and tear.
2. Exterior influences, e.g. transport damage, damage due to bumping and hitting, influences of weather or other natural phenomena.
3. Servicing, repairs or the opening of the dive computer by anybody not authorized to do so by the manufacturer.
4. Pressure tests which do not take place in water.
5. Diving accidents.
6. Opening the A1 housing.
7. Commercial use.
8. Exposing the unit to chemicals which include but are not limited to mosquito repellents and sunscreen.
9. Repairing with unauthorized spare parts.
10. Using any software or accessory which is not supplied by the manufacturer.

For European Union markets, the warranty of this product is governed by European legislation in force in each EU member state.

All warranty claims must be returned with dated proof-of-purchase to an authorized SCUBAPRO dealer. Visit www.scubapro.com to locate your nearest dealer.

6.6 Compliance

6.6.1 EU Radio directive

Hereby, Uwatec AG, declares that the radio equipment type PAN1740 is in compliance with Directive 2014/53/EU. The full text of the EU declaration of conformity is available from the official SCUBAPRO importers in EU.

6.6.2 Diving

A1 dive instrument is also compliant with the European standard EN 13319: 2000 (EN 13319: 2000 – Depth gauges and combined depth and time measuring devices – Functional and safety requirements, test methods).

6.6.3 FCC & ISED regulatory notices

6.6.3.1 Modification Statement

Uwatec has not approved any changes or modifications to this device by the user. Any changes or modifications could void the user's authority to operate the equipment.

6.6.3.2 Interference Statement

This device complies with Part 15 of the FCC Rules and Industry Canada license-exempt RSS standard(s). Operation is subject to the following two conditions: (1) this device may not cause interference, and (2) this device must accept any interference, including interference that may cause undesired operation of the device.

6.6.3.3 Wireless Notice

This device complies with FCC/ISED radiation exposure limits set forth for an uncontrolled environment and meets the FCC radio frequency (RF) Exposure Guidelines and RSS-102 of the ISED radio frequency (RF) Exposure rules. This transmitter must not be co-located or operated in conjunction with any other antenna or transmitter.

The A1 contains TX FCC ID: T7V1740

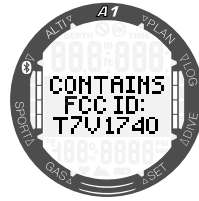

6.6.3.4 FCC Class B Digital Device Notice

This equipment has been tested and found to comply with the limits for a Class B digital device, pursuant to part 15 of the FCC Rules. These limits are designed to provide reasonable protection against harmful interference in a residential installation. This equipment generates, uses and can radiate radio frequency energy and, if not installed and used in accordance with the instructions, may cause harmful interference to radio communications. However, there is no guarantee that interference will not occur in a particular installation. If this equipment does cause harmful interference to radio or television reception, which can be determined by turning the equipment off and on, the user is encouraged to try to correct the interference by one or more of the following measures:

1. Reorient or relocate the receiving antenna.
2. Increase the separation between the equipment and receiver.
3. Connect the equipment into an outlet on a circuit different from that to which the receiver is connected.
4. Consult the dealer or an experienced radio/TV technician for help.

6.6.3.5 CAN ICES-3 (B) / NMB-3 (B)

This Class B digital apparatus complies with Canadian ICES-003.



Your dive instrument is manufactured with high-quality components that can be recycled and reused. Nevertheless, these components, if not properly managed in accordance with the regulations on electrical and electronic equipment waste, are likely to cause harm to the environment and/or to human health. Customers living in the European Union can contribute to protecting the environment and health by returning old products to an appropriate collection point in their neighborhood in accordance with EU Directive 2012/19/UE. Collection points are provided by some distributors of the products and local authorities. Products marked with the recycling symbol on the left must not be disposed of in normal household waste.

6.7 Manufacturer

UWATEC AG
Bodenackerstrasse 3
CH-8957 Spreitenbach
SWITZERLAND

7. GLOSSARY

AVG	Average Depth. Calculated from the beginning of the dive or from the time of reset.
CNS O ₂	Central Nervous System Oxygen toxicity.
DESAT	Desaturation Time. The time needed for the body to completely eliminate any nitrogen taken up during diving.
Dive Time	The time spent below a depth of 0.8m/3ft.
Gas	Refers to the main gas that is set for the ZH-L16 ADT MB algorithm.
Local Time	Current time in the local time zone.
Max Depth	Maximum depth attained during the dive.
MB	Microbubbles: Microbubbles are tiny bubbles that can build up in a diver's body during and after a dive.
MB Level	One of 6 levels (L0-L5), provided by the A1's ZH-L16 ADT algorithm.
MOD	Maximum Operating Depth. This is the depth at which the partial pressure of oxygen (ppO ₂) reaches the maximum allowed level (ppO ₂ max). Diving deeper than the MOD will expose the diver to unsafe ppO ₂ levels.
Nitrox	A breathing mix made of oxygen and nitrogen, with the oxygen concentration being 22% or higher.
NO FLY	Minimum amount of time a diver should wait before flying.
No-Stop Time	The amount of time a diver can stay at the current depth and still make a direct ascent to the surface without having to perform decompression stops.
O ₂	Oxygen.
O ₂ %	Oxygen concentration used by the A1 in all calculations.
OTU	Oxygen Toxicity Unit
PDIS	Profile Dependent Intermediate Stop is an additional deep stop which is suggested by the A1 at a depth where the 5th, 6th or 7th compartment starts off-gassing.
ppO ₂	Partial pressure of oxygen. This is the pressure of the oxygen in the breathing mix. It is a function of depth and oxygen concentration. A ppO ₂ higher than 1.6bar is considered dangerous.
ppO ₂ max	The maximum allowed value for ppO ₂ . Together with the oxygen concentration, it defines the MOD.
Press-and-hold	The act of pressing-and-holding the button for 1 second before releasing.
SOS Mode	The result of having completed a dive without respecting all mandatory decompression obligations.
SURF INT	Surface interval. The time that starts at the moment the dive is closed out.
TAT	Total Ascent Time.
UTC	Universal Time Coordinated. This is the primary time standard used worldwide to regulate clocks and time. UTC correlates to your location's time zone through the use of offsets ranging from -12 to +14 hours.

8. INDEX

Active backlight	11, 20, 40
Altimeter	19
Apnea mode.....	19, 27, 39, 52
Ascent rate.....	43, 46
Battery	11, 24, 44, 59
Buttons	9, 9
Buttons functions	9, 17, 35
Clock settings.....	14
CNS O ₂	41, 43, 50
Decompression.....	33, 35, 37, 43, 42, 42
Date	13, 16
Desaturation	21, 51
Diving at altitude	48
Flying after diving.....	49
Gauge mode	38, 51
Logbook.....	34, 54
LogTRAK.....	21, 30, 40, 54
Maintenance.....	59
MB levels.....	26, 42, 42, 45
Microbubbles.....	45
MOD	31, 33, 42
Mountain lakes	50
No-dive warning	33
Nitrox	32, 50
Nitrox reset	32
No-fly time.....	48
Oxygen concentration	50, 58
Oxygen partial pressure	31, 50
OTU	50
PC interface.....	53
Planner.....	32, 33, 33
ppO ₂ max	50
Safety stop	40, 47
SOS	43
Software.....	22,56
Stealth mode.....	24
Stopwatch.....	18
Surface interval.....	19, 27, 29, 39
Technical information	58
Time zone	15, 15
Units.....	14, 20, 21, 55
UTC.....	15, 15
Wake-up alarm	15
Warnings	24, 30, 40, 55
Warranty.....	59
Water contact.....	10, 59
Water type.....	26, 32

