

XPLORE, APEX and SOLIX

Operations Manual

532793-2EN_A



SIMPLY. CLEARLY. BETTER.

THANK YOU!

Thank you for choosing Humminbird®, the #1 name in marine electronics. Humminbird has built its reputation by designing and manufacturing top quality, thoroughly reliable marine equipment. Your Humminbird is designed for trouble-free use in even the harshest marine environment. In the unlikely event that your Humminbird does require repairs, we offer an exclusive Service Policy. For complete details, see the separate warranty card included with your unit. We encourage you to read this operations manual carefully in order to get the full benefit from all the features and applications of your Humminbird product.

Contact Humminbird Technical Support at humminbird.johnsonoutdoors.com or call 1-800-633-1468.

WARNING!

This device should not be used as a navigational aid to prevent collision, grounding, boat damage, or personal injury. When the boat is moving, water depth may change too quickly to allow time for you to react. Always operate the boat at very slow speeds if you suspect shallow water or submerged objects.

The electronic chart in your Humminbird unit is an aid to navigation designed to facilitate the use of authorized government charts, not to replace them. Only official government charts and notices to mariners contain all of the current information needed for the safety of navigation, and the captain is responsible for their prudent use.

Compass Safe Distance: The control head must be installed at least 4 feet [1.2 meters] from the compass or other magnetic equipment on the boat. Also, see your compass installation guide for details.

This device is granted for use in Mobile only configurations in which the antennas used for this transmitter must be installed to provide a separation distance of at least 8 inches [20 cm] from all person and not be co-located with any other transmitters except in accordance with FCC and Industry Canada multi-transmitter product procedures.

Humminbird is not responsible for the loss of data files [waypoints, routes, tracks, groups, recordings, etc.] that may occur due to direct or indirect damage to the unit's hardware or software. It is important to back up your control head's data files periodically. Data files should also be saved to your PC before restoring the unit's defaults or updating the software. Review the information in this manual for details.

Disassembly and repair of this electronic unit should only be performed by authorized service personnel. Any modification of the serial number or attempt to repair the original equipment or accessories by unauthorized individuals will void the warranty.

Do not travel at high speed with the unit cover installed. Remove the unit cover before traveling at speeds above 20 mph.

The user shall maintain 20 cm separation from the RF device to ensure compliance with RF exposure.

NOTES

Some features discussed in this manual require a separate purchase, and some features are only available on international models. Every effort has been made to clearly identify those features. Please read the manual carefully in order to understand the full capabilities of your model.

The illustrations in this manual may not look the same as your product, but your unit will function in a similar way.

To purchase accessories or any additional equipment for your fish finder configuration, contact Humminbird Technical Support through our Web site at humminbird.johnsonoutdoors.com.

The procedures and features described in this manual are subject to change without notice. This manual was written in English and may have been translated to another language. Humminbird is not responsible for incorrect translations or discrepancies between documents.

Product specifications and features are subject to change without notice.

Humminbird verifies maximum stated depth in saltwater conditions, however actual depth performance may vary due to transducer installation, water type, thermal layers, bottom composition, and slope.

ROHS STATEMENT: Product designed and intended as a fixed installation or part of a system in a vessel may be considered beyond the scope of Directive 2002/95/EC of the European Parliament and of the Council of 27 January 2003 on the restriction of the use of certain hazardous substances in electrical and electronic equipment.

APEX™, AutoChart®, AutoChart® LIVE, ChartSelect®, CoastMaster®, Cross Touch®, Down Imaging®, DualBeam PLUS™, Dual Spectrum™, Fish ID+™, Humminbird®, Humminbird Basemap™, LakeMaster®, MEGA 360 Imaging®, MEGA Imaging™, MEGA Down Imaging™, MEGA Down Imaging+™, MEGA Live Imaging™, MEGA Side Imaging™, MEGA Side Imaging+™, Real Time Sonar™, RTS Window™, SI™, Side Imaging®, SmartStrike™, SOLIX®, Structure ID™, SwitchFire®, WhiteLine™, XPLORE™, X-Press™ Menu, and Zero Line Map Card™ are trademarked by or registered trademarks of Johnson Outdoors Marine Electronics, Inc.

Airmar is a registered trademark of Airmar Technology Corp.

Adobe, Acrobat, Adobe PDF, and Reader are either registered trademarks or trademarks of Adobe Systems Incorporated in the United States and/or other countries.

Baekmuk Batang, Baekmuk Dotum, Baekmuk Gulim, and Baekmuk Headline are registered trademarks owned by Kim Jeong-Hwan.

The Bluetooth® word mark and logos are registered trademarks owned by the Bluetooth SIG, Inc. and any use of such marks by Johnson Outdoors, Inc. is under license. Other trademarks and trade names are those of their respective owners.

Gentoo™ is a trademark of Gentoo Foundation, Inc.

microSD and SD are trademarks or registered trademarks of SD-3C, LLC in the United States, other countries or both.

Navionics® is a registered trademark of Navionics S.p.A.



NMEA 2000® is a registered trademark of the National Marine Electronics Association.

TABLE OF CONTENTS

Warnings	2	Manage your Navigation Data	107
Introduction	6	Manage Waypoints	109
Using Humminbird Manuals on your Mobile Device or Computer . . .	7	Manage Routes	111
Fish Finder Overview	8	Manage Tracks	114
Keypad Functions for XPLORE	9	Manage Groups	117
Keypad Functions for APEX and SOLIX	11	Delete All Navigation Data	118
Touch Screen Functions	13	Import/Export Navigation Data	118
SD Card Slots	16	AutoChart LIVE Overview	119
Power On/Off	17	Plan your Map	119
Getting Started	18	Prepare the Fish Finder for Mapping	120
Update Software	25	Record your Custom Map	123
The Home Screen	29	Stop Recording	124
The Menu System	33	Display the AutoChart Live Map	125
Views	42	Adjust the Map Display Settings	128
Create a New View	46	Customize the Bottom Hardness Display Settings	132
The View Options Menu	47	Customize the Vegetation Display Settings	135
Display a Data Bar	52	Sonar Overview	138
Set up an Instrument View	57	Sonar Setup	144
Set up an HDMI View	59	Sonar Alarms	145
Chart Overview	61	2D Sonar Overview	146
Map Source Overview	62	Customize the 2D Sonar View	147
Customize the Chart View	72	Open the 2D Sonar X-Press Menu	147
Change the Chart View Data Overlays	82	Change the 2D Sonar View Overlays	152
Navigation Alarms Overview	83	Adjust 2D Sonar Display Settings	153
Man Overboard (MOB) Navigation	86	Side Imaging Overview	158
Introduction to Navigation	87	Customize the Side Imaging View	160
Navigation Menu Overview	88	Open the Side Imaging X-Press Menu	160
Navigation X-Press Menu	88	Change the Side Imaging View Overlays	162
Cursor Menu	90	Adjust Side Imaging Display Settings	163
Info Menu	92	Down Imaging Overview	166
Waypoints	93	Customize the Down Imaging View	167
Routes	98	Open the Down Imaging X-Press Menu	167
Search	103	Change the Down Imaging View Overlays	170
Tracks	104	Adjust Down Imaging Display Settings	171
		Use Cursor and Zoom in Sonar Views (2D, SI, DI)	174

TABLE OF CONTENTS

Navigation in Sonar Views (2D, SI, DI)	176
Sonar Recording	178
Images Tool	180
Installation Information	185
Set up or Change Transducer Settings (advanced settings) . . .	186
Configure the Fish Finder	189
Set up a NMEA 2000 Network	192
Set up your Humminbird Network	201
Manage your Fish Finder	207
Specifications	208
Statements and Acknowledgments	225
Contact Humminbird	231

INTRODUCTION

The instructions in this manual describe the XPLORE, APEX and SOLIX fish finder operations. For an overview of functions, see the Quick Start Guide included with your product.

Build your Network: Some of the features shown in this manual require a separate purchase. MEGA 360, MEGA Live 2, Radar, Talon, Raptor, AIS, NMEA 2000 GPS Heading Sensor, Ethernet Switch, Advanced GPS Wireless Remote, etc. require a separate purchase. To install each accessory, use the installation guide provided with it, or download the guide from our Web site at **humminbird.johnsonoutdoors.com**.

Register and Update: As you build your Humminbird network, it is important to register your products and keep your software up to date. Visit our Web site at **humminbird.johnsonoutdoors.com** to register your Humminbird products, update fish finder and accessory software, and purchase additional equipment. Also, see **Update Software** in this manual for more information.

USING HUMMINBIRD MANUALS ON YOUR MOBILE DEVICE OR COMPUTER

The Humminbird manuals for your fish finder and accessories can be downloaded to your mobile device or computer. If you prefer to use a hard copy for reference, this manual may be printed.

Download the Manual to your Mobile Device

1. Download the free Adobe Acrobat Reader app to your mobile device.
2. Go to our Web site at humminbird.johnsonoutdoors.com, and click Support > Manuals.
3. Select the PDF for your fish finder model or accessory, and save it to your device.
4. Open the Adobe Acrobat Reader app.
5. Open the Humminbird manual.

Download the Manual to your Computer

1. Download the free Adobe Acrobat Reader software from <http://get.adobe.com/reader/>, and install it on your computer.
2. Go to our Web site at humminbird.johnsonoutdoors.com, and click Support > Manuals.
3. Select the PDF for your fish finder model or accessory, and save it to your computer.
4. Open Adobe Acrobat Reader.
5. Open the Humminbird manual.

Jump to a Section: Click a section name in the Bookmarks panel. Bookmarks can be expanded and collapsed by clicking on the plus [+] or minus [-] icons.

Search for Words or Phrases: Press and hold the Ctrl F keys on your keyboard. Type the word(s) into the text box.

Print: To print, confirm the page sizing is 8.5 x 11" and set to Fit. Set the page orientation to Portrait.

Using the Manual



FISH FINDER OVERVIEW

The XPLORE, APEX and SOLIX fish finders includes CrossTouch, which allows you to use both the touch screen and keypad to make selections. Review this section for an overview of touch and keypad functions.

XPLORE

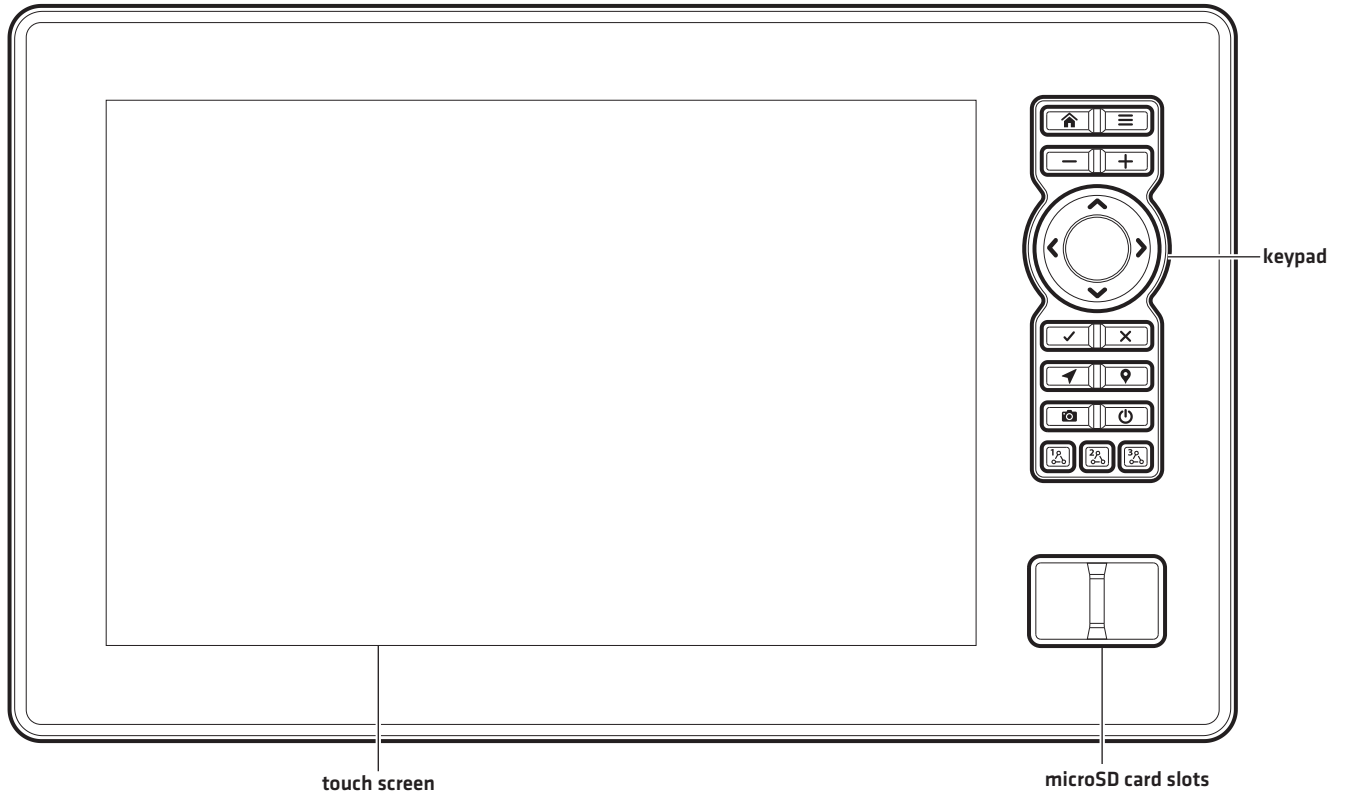

APEX

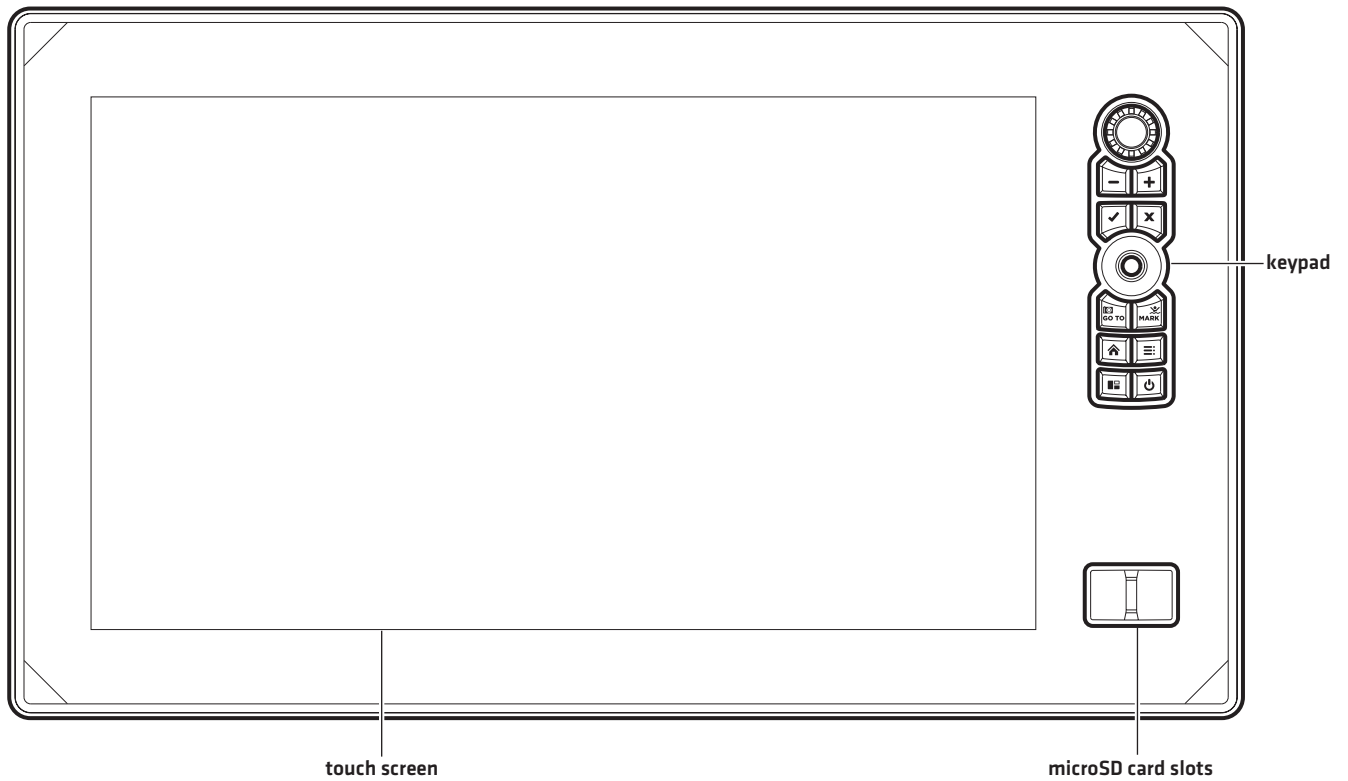

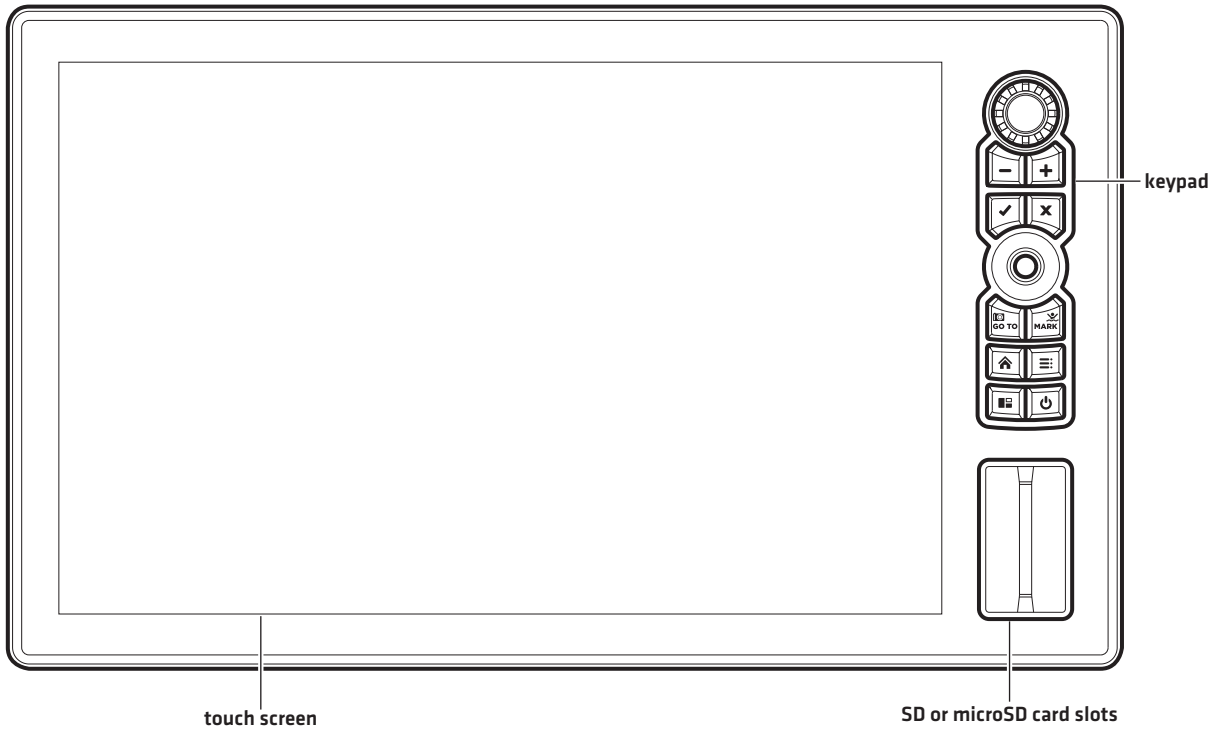

Keypad Functions for XPLORE

The functions for each key are described here. To apply the key functions, see each section of this manual.



Cursor Pad













Move Functions

Move to select a view, tool, widget, or menu.

Move to activate and/or move the cursor across the displayed view.

Key	Name	Key Press Function(s)	Key Press Function(s)
	POWER key	Powers on the fish finder. During operation, this key opens the Power X-Press Menu.	Powers off the fish finder.
	ENTER key	Starts a command. Selects, or turns on, a setting. Opens menus.	May vary with the displayed view.
	EXIT key	Closes an open menu or dialog box. Turns off an alarm. Exits Cursor mode. Returns to the last displayed view from the Home screen.	Closes all open sub-menus and menus.

Key	Name	Key Press Function(s)	Key Press Function(s)
	HOME key	Displays the Home screen. See <i>The Home Screen</i> .	
	MENU key	Opens the X-Press Menu for the on-screen view and operation mode.	
	ZOOM In key	Changes the scale of the view to show a closer perspective.	Increases a selected setting.
	ZOOM Out key	Changes the scale of the view to show a wider view.	Zoom out all the way. Decreases a selected setting.
	Navigation key	Opens the Navigation menu for navigation functions [see <i>Routes</i> for details].	
	Screen Snapshot key	Saves the on-screen view [image]. See <i>Images Tool</i> .	
	Waypoint key	Press to mark waypoints.	
	OBN 1	Customizable One-Boat Network button. The default is set to Favorite View 1. Press and hold the OBN button to change the function.	
	OBN 2	Customizable One-Boat Network button. The default is set to Favorite View 2. Press and hold the OBN button to change the function.	
	OBN 3	Customizable One-Boat Network button. The default is set to Favorite View 3. Press and hold the OBN button to change the function.	

Keypad Functions for APEX and SOLIX

The functions for each key are described here. To apply the key functions, see each section of this manual.

Joystick (APEX and SOLIX Only)

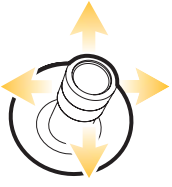

Move Functions

Move to select a view, tool, widget, or menu.

Move to activate and/or move the cursor across the displayed view.

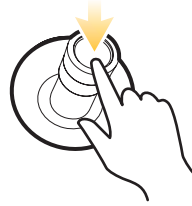

(Down) Press Functions

Open your selected view, tool, widget, menu, or sub-menu.

Mark a route point.

Rotary Dial (APEX and SOLIX Only)

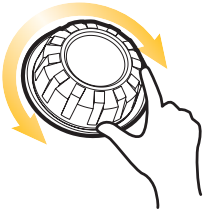

Turn Functions

Turn to adjust menu settings.

Turn to adjust the sensitivity in Sonar Views.

Turn to zoom in and out in Chart View.



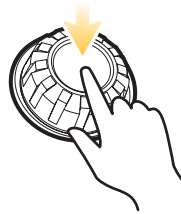







Turn to adjust in Radar View.



(Down) Press Functions

Press the Rotary dial to open the Minn Kota Sidebar.

*requires a connected Minn Kota trolling motor.

Key	Name	Key Press Function(s)	Key Press Function(s)
	POWER key	Powers on the fish finder. During operation, this key opens the Power X-Press Menu.	Powers off the fish finder.
	ENTER key	Starts a command. Selects, or turns on, a setting. Opens menus.	May vary with the displayed view.
	EXIT key	Closes an open menu or dialog box. Turns off an alarm. Exits Cursor mode. Returns to the last displayed view from the Home screen.	Closes all open sub-menus and menus.
	Go To/Navigation & Screen Snapshot key	Opens the Navigation menu for navigation functions [see Routes for details].	Screen Snapshot: Saves the on-screen view [image]. See Images Tool .
	PANE key	Activates the Side Bar [the Side Bar is highlighted in yellow]. Use the Joystick to scroll through the Side Bar widgets. Selects a pane in a multi-pane view [the selected pane is highlighted in yellow. See Views .]	
	MARK & Man Overboard key	Press to mark waypoints.	Man Overboard: Starts Man Overboard [MOB] Navigation. See Man Overboard [MOB] and Introduction to Navigation .
	HOME key	Displays the Home screen. See The Home Screen .	
	ZOOM In key	Changes the scale of the view to show a closer perspective.	Increases a selected setting.
	ZOOM Out key	Changes the scale of the view to show a wider view.	Zoom out all the way. Decreases a selected setting.
	MENU key	Opens the X-Press Menu for the on-screen view and operation mode.	

Touch Screen Functions

The touch screen actions are also determined by the view displayed on the screen.

Using the Touch Screen

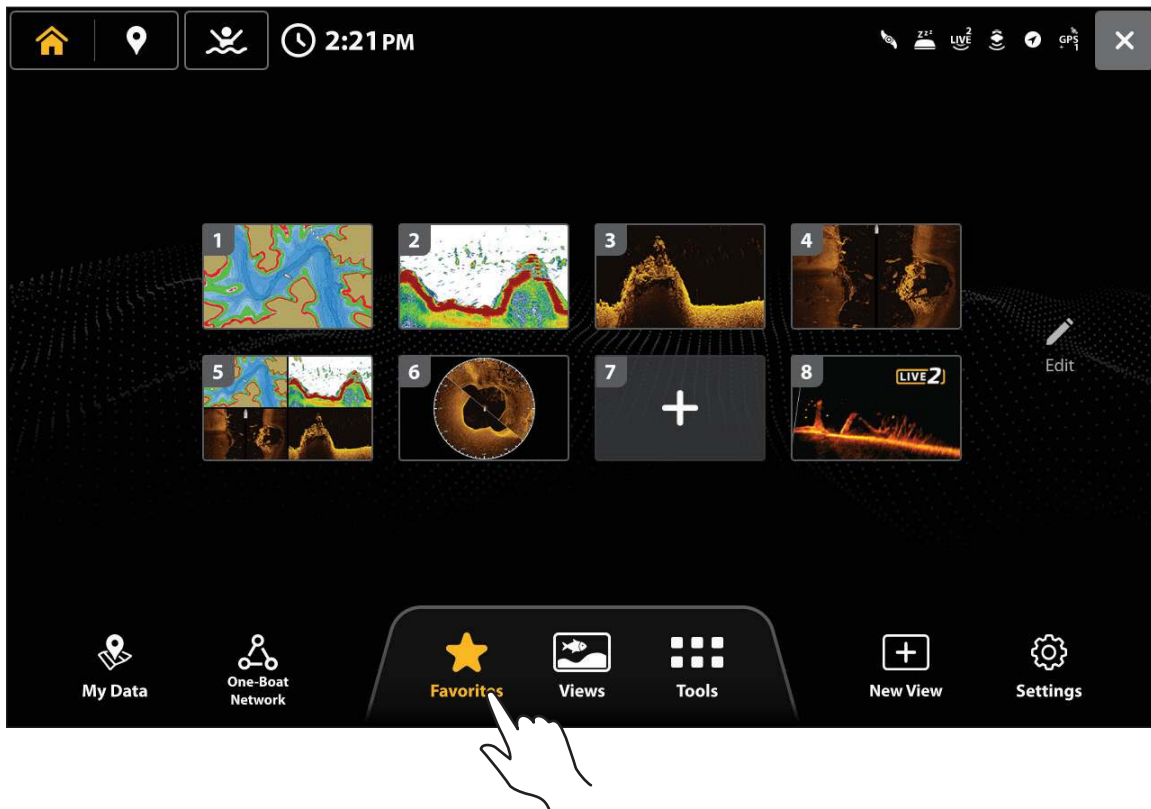

Swipe Functions

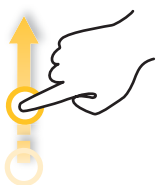

One Finger Swipe (vertical)

Browse Menus: Scroll through a menu or list [up or down].



One Finger Swipe (horizontal)

Adjust Menu Slider: Drag the slider to adjust the setting.

With a Chart View displayed on the screen, drag one finger across the screen to see more of the chart that is displayed off-screen.

With a 2D Sonar View displayed on the screen, drag one finger across the screen to see more of the sonar history.



Two Finger Swipe

With a view displayed on-screen, touch the screen with two fingers and swipe down to return to the Home screen.

Tap Functions



One Tap

Select (Open): Tap to select (or open) a view, tool, widget, menu, or icon.

Activate the Cursor: Tap a position on the view once.



Two Taps

Tap the screen twice to zoom in on the current display.

Press and Hold Functions



Pinch

Zoom In: Touch the screen with two fingers and move them apart to zoom in on the display.

Zoom Out: Touch the screen with two fingers and bring them closer together to zoom out.



Press and Hold

Press and hold a position on the view with one finger to open the Cursor Menu.

Basic Touch Screen and Keypad Operations

Select (Open) a Tool, Widget, or View

Touch Screen

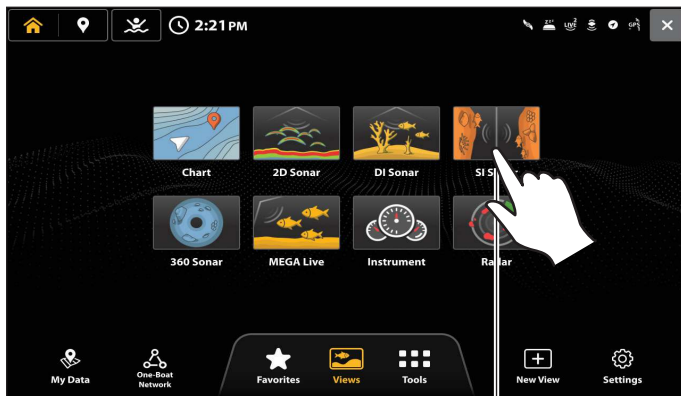

tap to open

Open an X-Press Menu

Touch Screen

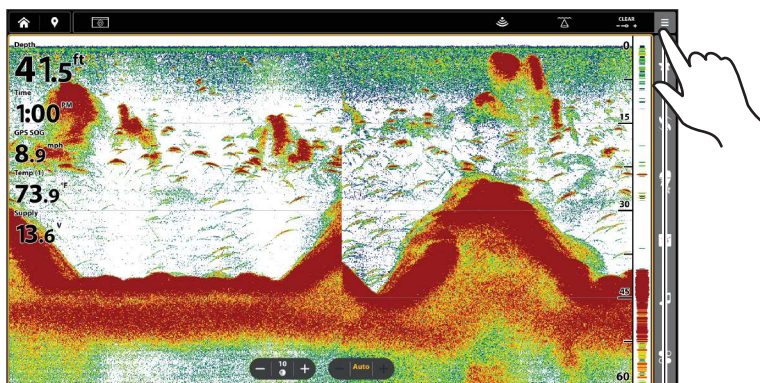

tap to open

Keypad

XPLORE



APEX/SOLIX



Adjust a Menu Setting

Touch Screen

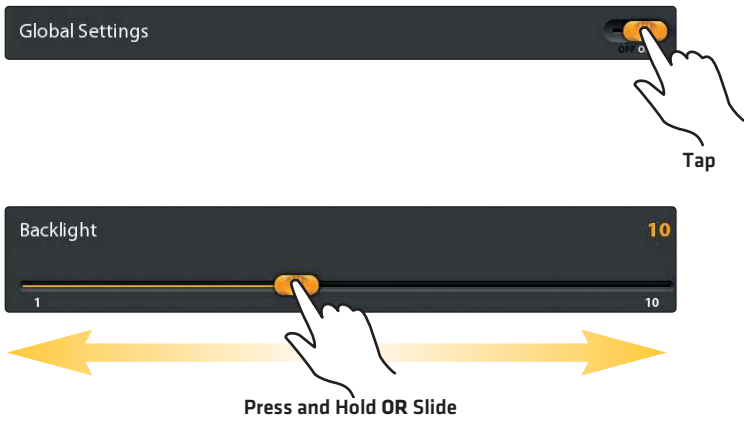

Keypad

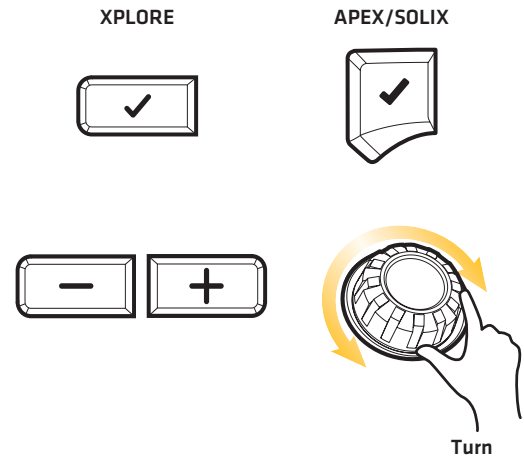

Close a Tool or Menu

Touch Screen

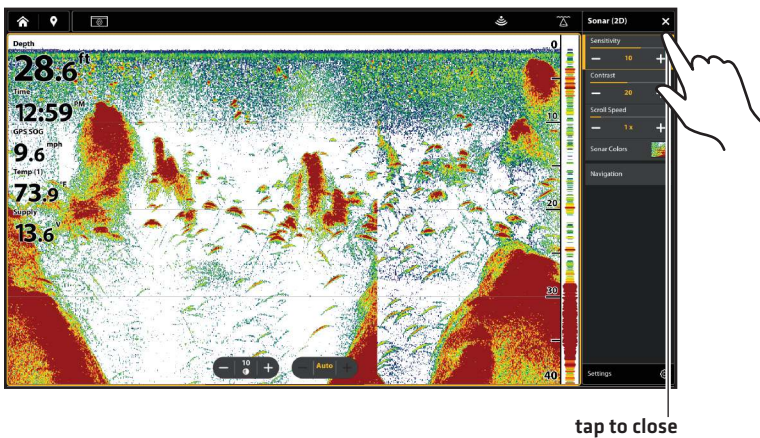

Keypad

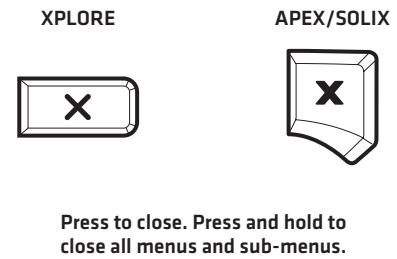

SD Card Slots

Your fish finder may be compatible with an SD or microSD card [separate purchase required]. Use it to update software, add detailed charts to your fish finder, import/export navigation data, and save sonar recordings and screen snapshots. Use the instructions in this section to install the card.

CAUTION

Before the fish finder software is updated or restored to system defaults, export your navigation data [see *Update Software*].

Do not leave the card slot cover open. The slot cover should always be closed to prevent water damage to the unit.

Insert an SD Card

The left slot is displayed as SD Card [1] in the menu system, and the right slot is displayed as SD Card [2].

1. Remove the SD card slot cover.
2. Position the SD card so that the label faces to the left.
3. Insert the card into the slot until it clicks into place.
4. Replace the slot cover so it is secure.
5. **Remove:** Press the card into the slot and then release it. The card will eject. Pull the card carefully from the slot.

Insert a microSD Card

The top slot is displayed as SD Card [1] in the menu system, and the bottom slot is displayed as SD Card [2].

1. Remove the microSD card slot cover.
2. Remove the microSD card from the microSD card adapter.
3. Position the microSD card so that the label faces the front of the fish finder and the card notches face down.
4. Insert the card into the slot until it clicks into place.
5. Replace the slot cover so it is secure.
6. **Remove:** Press the card into the slot and then release it. The card will eject. Pull the card carefully from the slot.

Load an SD Card

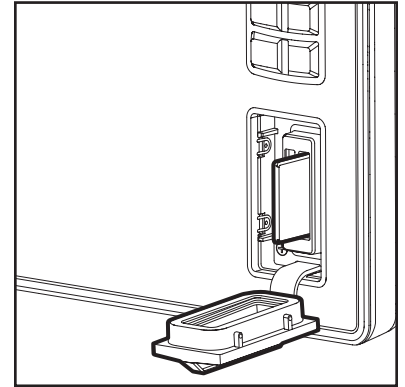

Vertical Slot:

Insert the SD card with the label facing left.

Horizontal Slot:

Insert the SD card with the label facing up.

POWER ON/OFF

Power On

1. Press the POWER key.
2. When the first view is displayed on the screen, the fish finder is ready for operation.

NOTE

The first time the fish finder is powered on, and after each software update, a Welcome dialog box is shown. Select Start Normal Mode to continue to the Setup Screen.

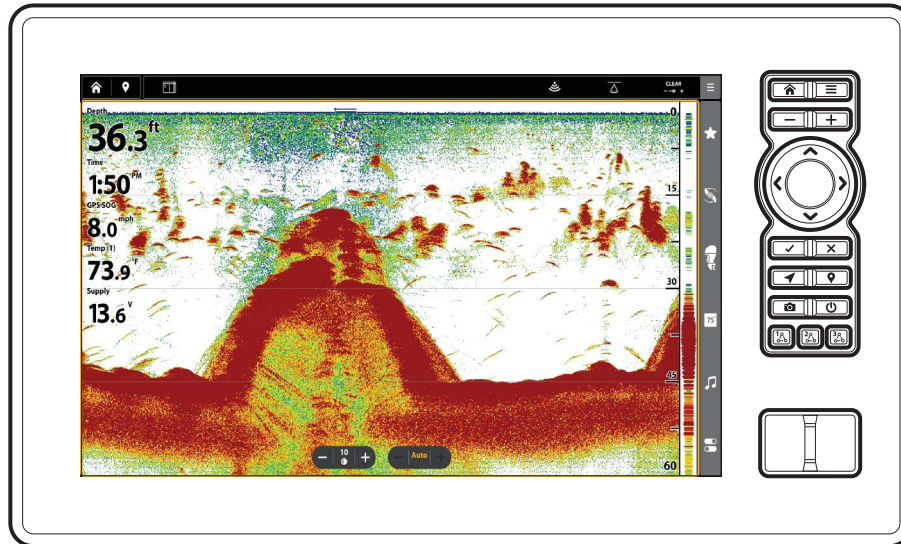

Use Standby Mode to Conserve Power

To conserve power while the fish finder is not in-use, start Standby mode from the Power X-Press Menu.

1. **Open the Power X-Press Menu:** Press the POWER key.
2. Select Standby.
3. **Turn off Standby Mode:** Press the POWER key.

Power Off

1. **Open the Power X-Press Menu:** Press the POWER key.
2. Select Power Off.
3. Select Confirm.



Additional Keypad Option

Press and hold the POWER key.

GETTING STARTED

The procedures in this section describe how to get started with your fish finder:

- review GPS reception
- check connected accessories and sensors
- pair the fish finder to the One-Boat Network App.
- set alarms

See your fish finder installation guide and the quick start guide included with your XPLORE, APEX or SOLIX to configure the unit for first time setup. Also, see **Installation Information** in this manual for network configuration details.

NOTE

When the fish finder equipment and accessories are first installed, the Setup Guide provides the prompts to guide you through configuring the unit. The Setup Guide includes important steps to configure the fish finder with the equipment, including vessel dimensions, map source selection, and offset menus. See your fish finder installation guide to configure the unit for the first time.

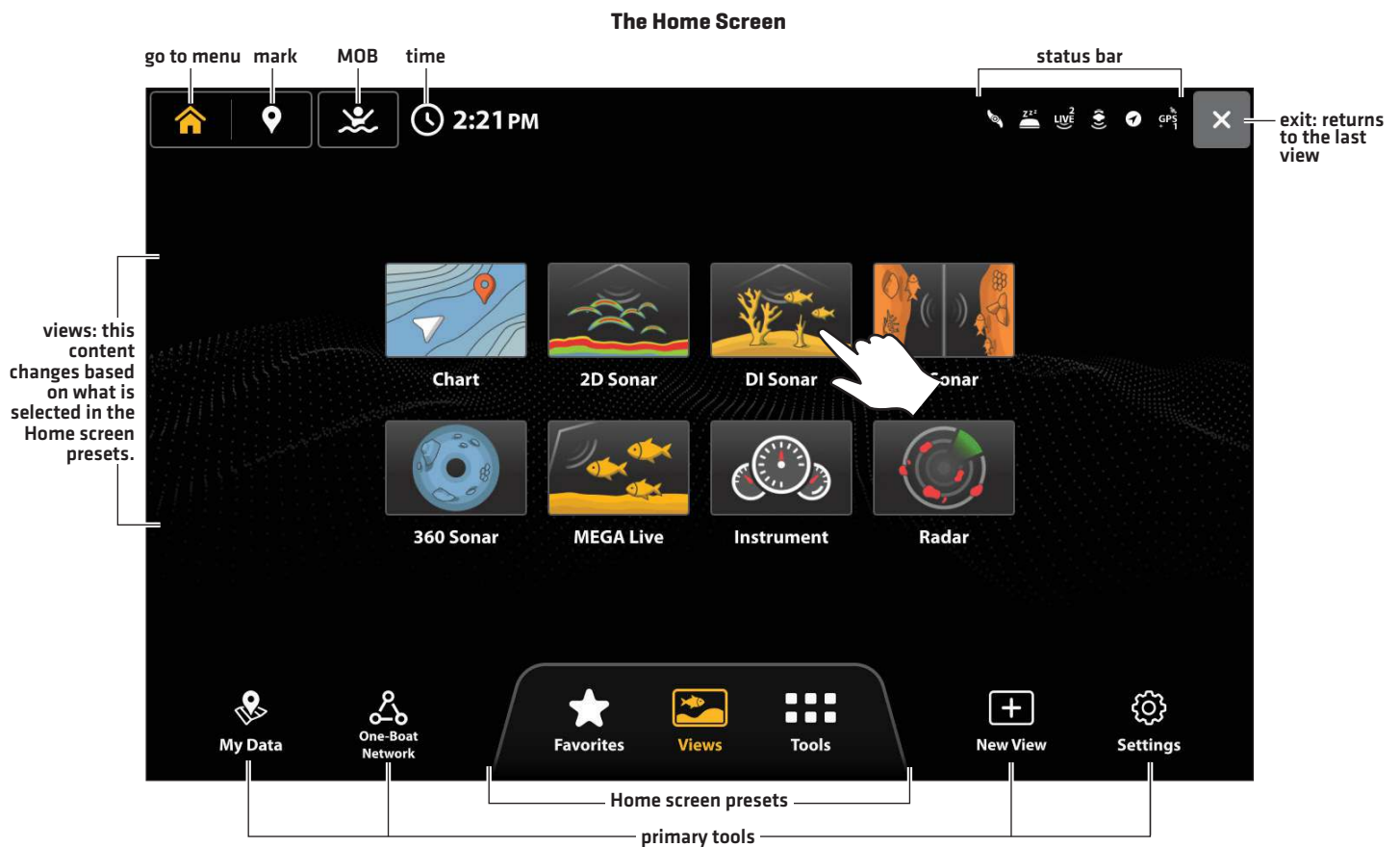

1 | Review GPS Reception

Use the GPS tool to check the GPS reception. The GPS tool provides two ways to view the satellites communicating with the GPS Receiver. **Yellow** indicates that the satellite is being used to determine your current position. **Teal** indicates that the satellite is being monitored but not used. The following data is also displayed:

- **Position** [latitude and longitude]
- **GPS Fix Type:** reported as No Fix, 2D Fix, 3D Fix, or Enhanced. An Enhanced fix has been augmented using information from WAAS, EGNOS, or MSAS. A 3D or Enhanced Fix is required for navigation.
- **HDOP [the Horizontal Dilution of Precision]:** a GPS system parameter which depends on the current satellite configuration. HDOP is used to calculate the Estimated Position Error.

Open the GPS Tool

If there is more than one fish finder installed on the network, select the fish finder that is connected directly to the GPS receiver.

1. Press the HOME key.
2. Select the Tools tab.
3. Select the GPS tool.

Review Satellites and Signal Strength

1. Under GPS [1], select Satellites.
2. Under GPS [1], select Signal Strength.

GPS (1) and GPS (2) Sources

You can also manually change which GPS receiver is the selected source for GPS [1] or GPS [2]. To change the GPS sources, see *Set up your Humminbird Network*.

- **GPS [1]** provides position data, Speed over Ground (SOG), Course over Ground (COG), waypoints, routes, tracks, and navigation calculations to the fish finder.
- **GPS [2]** provides position data that is displayed in the GPS [2] data box.

GPS [1] Satellite Sky Chart

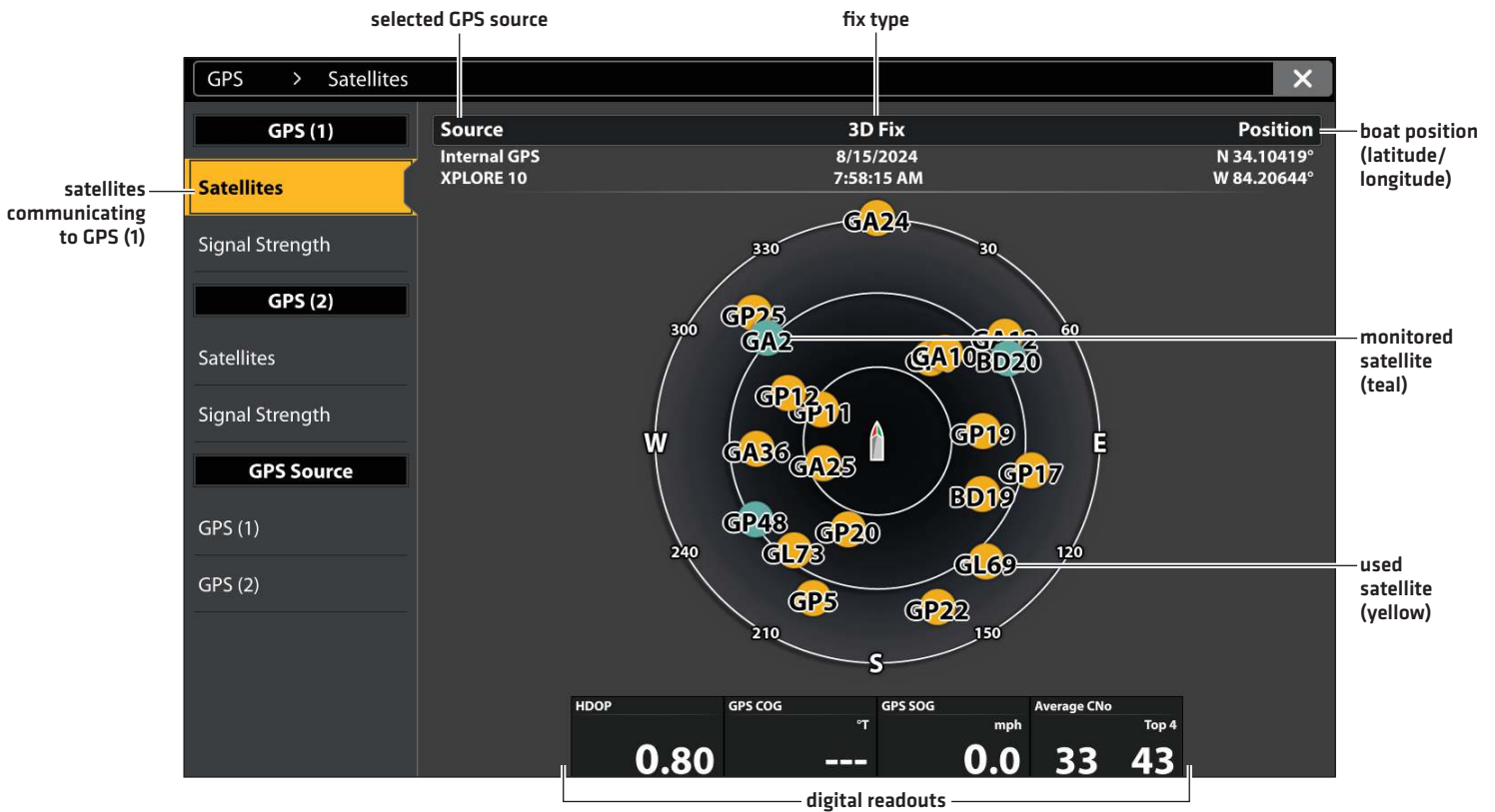

GPS [1] Satellites shows a sky chart and numerical data from the selected GPS receiver

Signal Strength (bar graph)

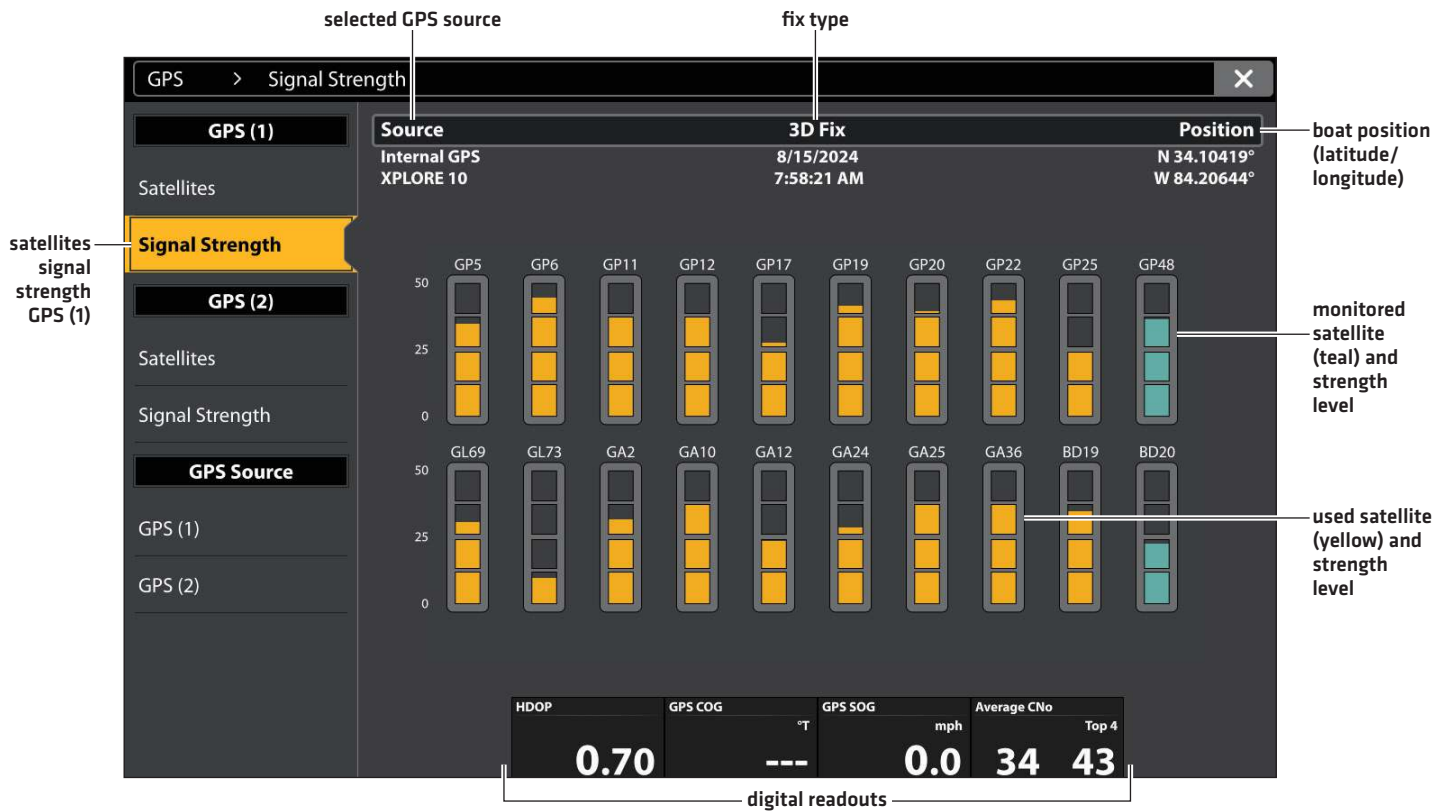

Signal Strength (GPS 1/GPS 2): displays vertical bar graphs indicating the satellite signal strengths with the respecting CNO (Carrier-to-Noise) value (0 to 60).

2 | Check Sensor Reception and Connections

If you've connected other separate-purchase equipment to the network, such as AIS, Compass/Heading Sensor, Radar, Advanced GPS Wireless Remote, MEGA Live 2, 360 Imaging, and more, use these instructions to confirm the equipment is detected and communicating with the fish finder.

1. Press the HOME key.
2. Review the top, right corner of the status bar.













Detected and Active: If a sensor is active and transmitting/receiving, it will be white. See the table below.



Connected but not Detected or Active: If a sensor is not detected on the network, or not transmitting/receiving, it will be completely gray.



Connected but not Transmitting/Receiving: If a sensor is detected, but is not transmitting/receiving, the icon will be partially gray. In this illustration, the GPS receiver is detected, but it doesn't have a GPS fix. This feature will vary with the type of icon represented.

Active Status Icon	Sensor	Icon Description
	AIS	AIS is on and receiving targets.
	Compass	The selected compass/heading sensor is on and heading data is being received.
	GPS	The GPS receiver is detected and a GPS fix has been obtained.
	Trolling Motor	Trolling motor is connected, enabled, and actively navigating.
	Bluetooth Talon	The Talon is connected and stowed. Download the Talon Accessory Manual from our Web site at humminbird.johnsonoutdoors.com for additional Talon status icons.
	Bluetooth Raptor	The Raptor is connected and stowed. Download the Raptor Accessory Manual from our Web site at humminbird.johnsonoutdoors.com for additional Raptor status icons.
	Radar	The selected radar source is detected and transmitting.
	2D Sonar	The selected 2D sonar source is detected and pinging.
	MEGA 360 Imaging Sonar	The 360 Imaging transducer is pinging data.
	MEGA Live 2 Imaging Sonar	The MEGA Live 2 Imaging transducer is pinging data.
	MEGA Live Imaging Sonar	The MEGA Live Imaging transducer is pinging data.

3. If the sensors are active, your system is ready for use on the water.

For additional system status, select Home > Settings > System > System Info.

If you have connected an accessory to the fish finder, and the icon is not displaying in the system status bar, check the installation of the accessory and the cable connection to the fish finder.

To change the NMEA 2000 network or multi-control head network sources, see *Set up a NMEA 2000 Network* and *Set up your Humminbird Network*.

3 | Pair the Fish Finder to the One-Boat Network App on a Mobile Device

Use the following instructions to pair the fish finder to the One-Boat Network App using Bluetooth wireless technology.

NOTES

If you have a Bluetooth compatible trolling motor or shallow water anchor (separate purchases required), see the accessory operations manual for each product for pairing instructions. Operations manuals can be downloaded from our Web site at humminbird.johnsonoutdoors.com.

WiFi or cellular data must be enabled on your mobile device.

Enable Bluetooth on your Mobile Device

1. Open the Settings menu on your mobile device.
2. Select Bluetooth.
3. Select On.

Pair the Phone with the Fish Finder

1. Press the HOME key.
2. Select One-Boat Network.
3. Under Phone Setup, select Connect Phone.
4. Follow the on-screen prompts to complete the pairing process.
5. Check the Bluetooth menu on your phone. Tap the name of the fish finder on your phone.
6. Confirm the six digit confirmation code and tap Pair on your phone.

Upon successful pairing, the fish finder will be listed as connected under the phone's Bluetooth menu.

7. **Reconnect:** The fish finder should automatically reconnect to your mobile device when in range. If it does not automatically reconnect, you can manually reconnect the fish finder by tapping on the name of the fish finder listed under My Devices (Apple iOS) or Previously Connected Devices (Google Android).

Pairing a Phone

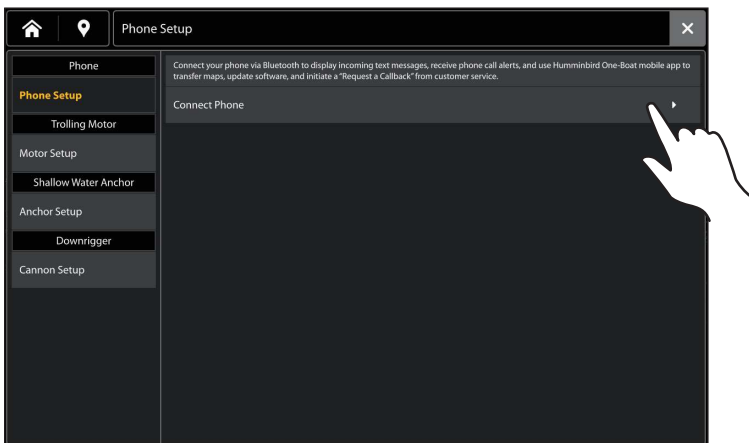

Starting the Pairing Process

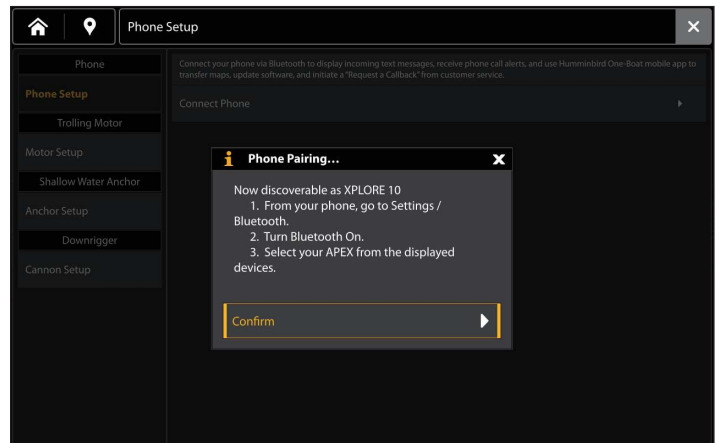

Forget Device

If you are having any issues with your connection, forget the device on both the phone and the fish finder and start the pair process over.

Forget Device on the Phone

1. **Apple iOS:** Open the phone's Bluetooth menu, and next to the fish finder's name under My Devices, tap the information icon.
Google Android: Open the phone's Bluetooth menu, and next to the control head's name under Available Media Devices, tap Settings.
2. **Apple iOS:** Tap Forget This Device.
Google Android: Tap Forget.

Forget Device on the Fish Finder

1. Press the HOME key.
2. Select One-Boat Network.
3. Under Phone Setup, select Forget Phone.

4 | Set Alarms

When an alarm is turned on, an alert will sound or display on the fish finder to indicate the threshold has been exceeded.

1. Press the HOME key.
2. Select Tools.
3. Select Alarms.
4. Select an alarm category.
5. Select an alarm name.
6. **On/Off:** Tap the on/off button, or press the ENTER key, to turn on the alarm.
7. Adjust the alarm threshold.

Touch Screen: Press and hold the slider, or drag the slider.

Keypad: Press and hold the ENTER key, or turn the Rotary dial [APEX/SOLIX only].

8. Repeat steps 4 through 7 for each alarm you want to set.

Selecting an Alarm

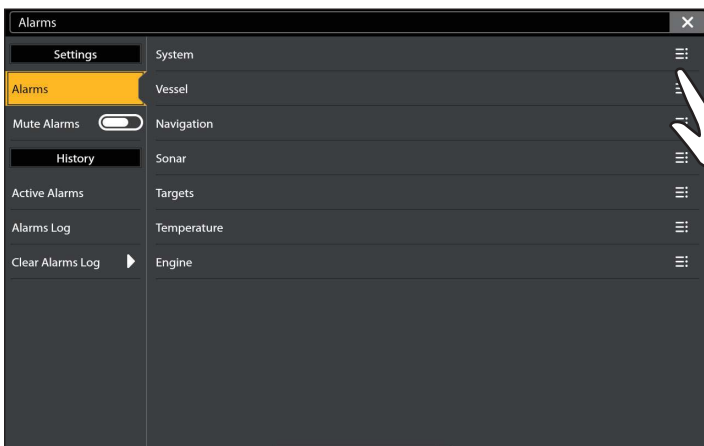

Setting Alarm Thresholds

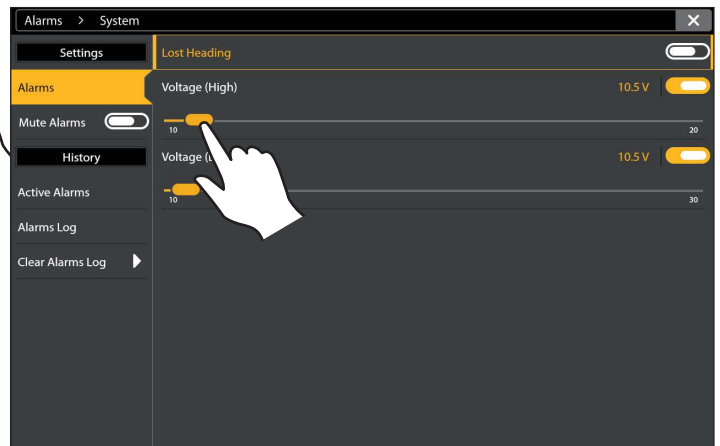

The available alarms are determined by the connected equipment, so your fish finder may provide more or less options than the information shown here.

System	Voltage, Lost Heading (compass/heading sensor required), etc.
Vessel	Drift Limit, SOG (Speed over Ground), STW (Speed through Water), etc. Also, see Views: Understand the Data Box Digital Readouts for more information.
Navigation	See Chart Overview: Navigation Alarms Overview for details.
Sonar	See Sonar Overview: Sonar Alarms for details.
Temperature	Temp (High) or Temp (Low). To change the Temperature sources, see Installation Information: Set up your Humminbird Network .
Engine	Low Fuel, Engine Temp, Oil Level, Coolant Level, Check Engine, etc. To change Engine and Fuel sources, see Installation Information: Set up a NMEA 2000 Network .

Use the following menus to view any alarms that have been triggered:

Active Alarms: View current, active alarms.

Alarms Log: View previously occurring alarms.

Change System Settings

Your fish finder was configured during the installation setup. To change the system settings such as the key sounds, units of measurement, and the time and date format (including Daylight Saving Time), select Settings from the Home screen. See **Manage your Fish Finder** for more information.

1. Press the HOME key.
2. Select Settings.
3. Select User Preferences.

Set up Sonar

Proceed to the **Sonar Overview** section.

Select the Map Source

Proceed to the **Chart Overview** section.

UPDATE SOFTWARE

As you build your Humminbird network, it is important to keep your fish finder and accessories software up to date. Accessories such as the NMEA 2000 GPS Heading Sensor, Advanced GPS Wireless Remote, MEGA 360 Imaging, MEGA Live2 Imaging, and Ethernet Switches are updated through the fish finder.

You can update software using an SD or microSD card (depending on your Humminbird model) or using the built-in Bluetooth and the One-Boat Network App.

Preparation: We recommend that you read this section completely before starting any software updates. Fish finders take approximately 10 minutes to update, and each fish finder on the network must be updated individually. Accessories take approximately 3 minutes to update.

CAUTION!

Humminbird is not responsible for the loss of data files (waypoints, routes, tracks, groups, snapshots, recordings, etc.) that may occur due to direct or indirect damage to the unit's hardware or software. It is important to back up your fish finder's data files periodically. Data files should also be saved to your computer before restoring the unit's defaults or updating the software.

1 | Register Products

Register your Humminbird equipment so that you will receive the latest Humminbird news, including accessory compatibility and software update information.

1. Go to our Web site at humminbird.johnsonoutdoors.com. Select Support > Register your Product.
2. Follow the on-screen prompts to register your products.

2 | Check the Current Software Version

It is helpful to review the software version number that is currently installed on the fish finder and each accessory.

1. Press the HOME key.
2. Select Settings.
3. Select System.
4. Select System Info.
Review the software version number listed.

3 | Download Software Updates

1. Install the SD card into the PC card slot.
2. Go to humminbird.johnsonoutdoors.com, and click Support > Software Updates.
3. The available software updates are listed as **Downloads** under each product.
 - Under Downloads, click the file name. Confirm the file name is for your Humminbird model.
 - Read the instructions in the dialog box and select Download.
 - Follow the on-screen prompts to save the software file to the SD card.
4. Repeat step 3 to download the software updates posted to each product.

4 | Update Fish Finder Software

Supplies: In addition to your Humminbird equipment, you will need a PC with Internet access and a blank 32 GB SD or microSD card (depending on your Humminbird model).

When you install the SD card with the software file, the fish finder will detect the update and provide an automatic prompt to install the software. You can follow the prompts or choose to install the software at a later time through the Software Updates tool. It is important to review the following tips:

- **Automatic Restart:** The fish finder will restart during the software update process.
- **Multiple Fish Finders:** If you have more than one fish finder on the network, go to each fish finder to install the latest software update. Fish finder software updates cannot be updated through another networked unit.

Update Software Automatically

1. Press the POWER key.
2. Install the SD card with the software file[s] into the fish finder card slot.
3. A dialog box will display to start the software update.

To start the fish finder software update, select Install. Once the software update is installed, the unit will power down and automatically restart.

OR

To update the software at a later time from the Software Updates tool, select Cancel. If you select Cancel, see *Update Software from the Software Updates Tool* in this section.

4. Select Start Normal Mode from the Welcome Screen.
5. Use the touchscreen to complete the Setup and tap Continue. If you have accessories to update, proceed to *Update Accessories*.

Update Software from the Software Updates Tool

1. Install the SD card with the software file[s] into the fish finder card slot.
2. Press the HOME key.
3. Select Tools.
4. Select the Software Updates tool.
5. Review the available software updates under This Unit. This will only populate if there is an available software update on the SD card.
6. Confirm that the most current version of software is selected from the list. Select Install Now. Once the software update is installed, the unit will power down and automatically restart.
7. Select Start Normal Mode from the Welcome Screen.
8. Use the touchscreen to complete the Setup and tap Continue. If you have accessories to update, proceed to *Update Accessories*.

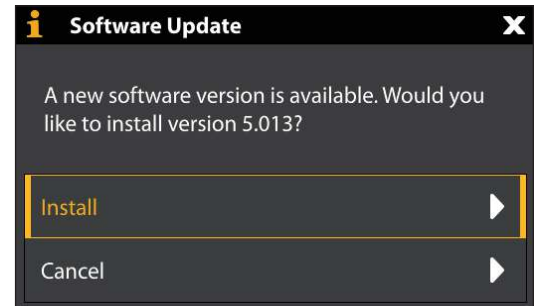

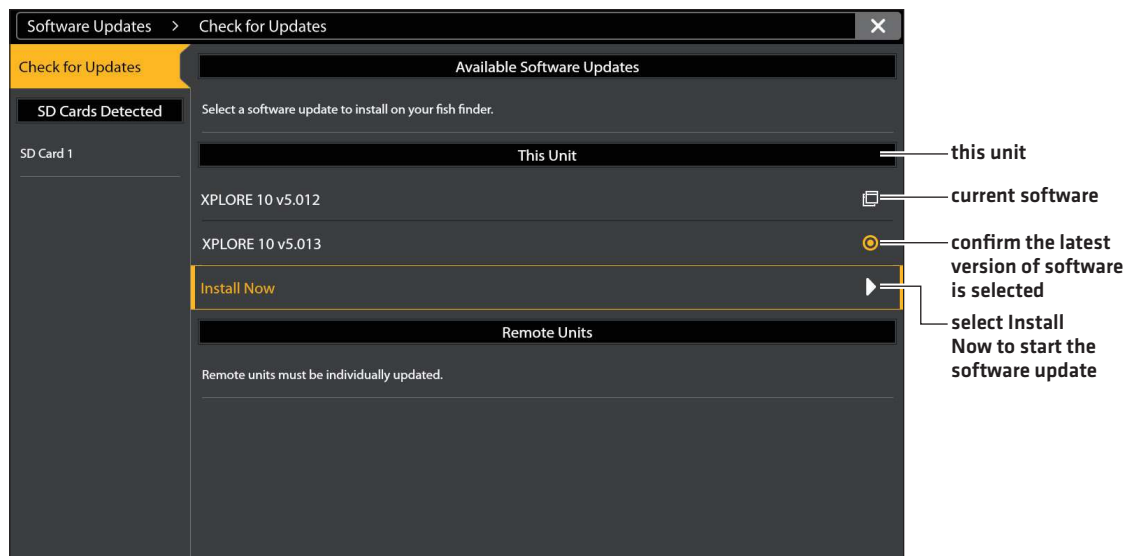

Update Software from the One-Boat Network App

NOTES

Your fish finder must already be running software release 4.130 or higher to support this feature.

You must first download the One-Boat Network App and pair your Minn Kota and Humminbird compatible products.

1. Open the One-Boat Network App on your mobile device.
2. Tap Network + Updates.
3. Tap Download Update next to the Humminbird device you want to update. The download progress is displayed on the screen. You can also tap More Options icon [...] next to the device you want to update, and then tap Download Update. Use this menu to pause or cancel the download [Apple iOS only].
4. Tap Transfer Software next to the selected device once the download is complete. You can also tap the More Options icon [...] again, and then tap Transfer Software or Delete Software.
5. Confirm the estimated transfer time.
6. Tap the radial button to select where to upload the software update [internal storage, SD card 1, or SD slot 2].

NOTE

You cannot download software updates to an SD or microSD card with LakeMaster charts saved to it.

7. Tap Start Transfer [Apple iOS] or Transfer [Google Android]. The upload progress is displayed under the selected unit in the One-Boat Network App and in the System Status view on the fish finder.
8. Follow the on-screen prompts on the fish finder to complete the software installation.

6 | Update Accessories

Accessory software is updated from the Software Updates tool, and the process is similar to updating the fish finder software. It is important to review the following tips:

- Update the fish finder and accessories in the order they appear on the Available Software Updates list.
- If an accessory is not displayed on the list, confirm it is detected on the network [Settings > System > Network Info]. Also, confirm the cable connections are secure.
- You might notice that the fish finder will restart during the software update. This is part of the update process.

- The **Advanced GPS Wireless Remote** has separate software updates for the controller and remote. After the software is updated on the control head, you must go to the remote and initiate the download of the remote software to the remote itself. See your Advanced GPS Wireless Remote manual for details.

Update Accessories from the Software Updates Tool

1. Install the SD card with the software file[s] into the fish finder card slot.
2. Press the HOME key.
3. Select Tools.
4. Select Software Updates.
5. Scroll to the first accessory in the list.
6. Confirm that the most current version of software is selected from the list. Select Install Now.

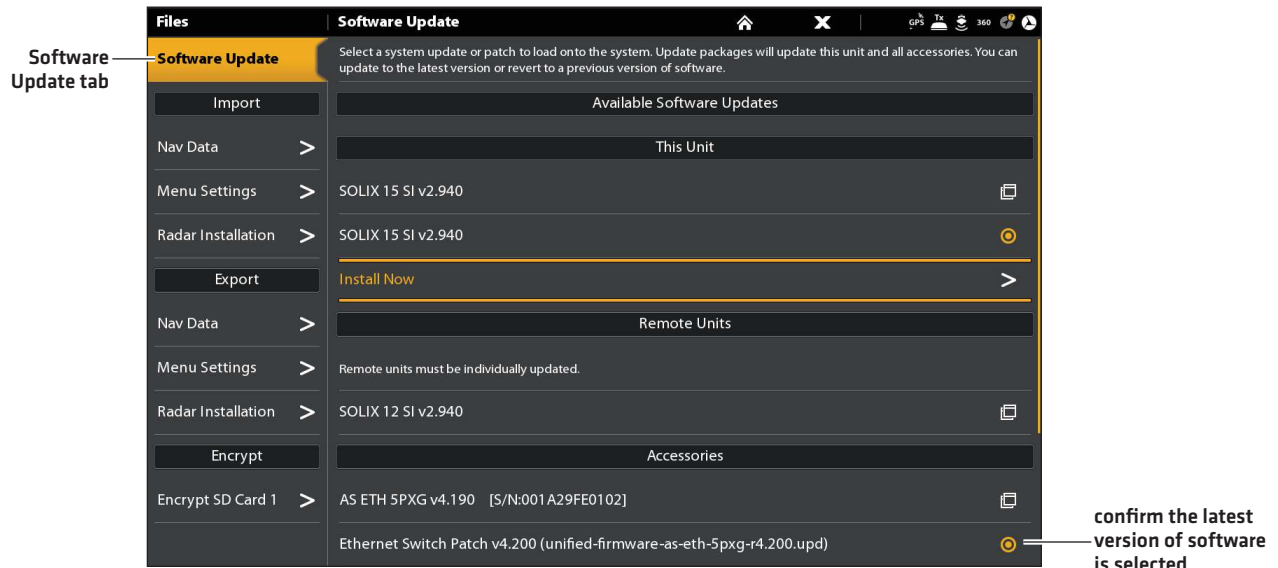

7. When the software update is finished, scroll to the next accessory update in the list [if applicable], and repeat step 6.

Update Accessory Software from the One-Boat Network App

1. Open the One-Boat Network App on your mobile device.
2. Tap Network + Updates.
3. Tap Download Update next to the device you want to update. The download progress is displayed on the screen.
4. Tap Transfer Software next to the selected device once the download is complete. The device will power cycle once complete.

THE HOME SCREEN

The Home screen is the main control center for your fish finder. Use the Home screen to access the settings, navigation data, views, favorites, and other tools.

- Tools and views available on the Home screen are determined by the equipment attached to the Humminbird Network.
- Favorite views can be saved for quick access and customized views can be created.
- Pair your Bluetooth capable fish finder to the One-Boat Network App.

Open the Home Screen

Touch Screen

1. With a view displayed on-screen, touch the screen with two fingers and swipe down.

OR

2. Tap the Home icon in the top left corner of the screen.

Keypad

1. Press the HOME key.

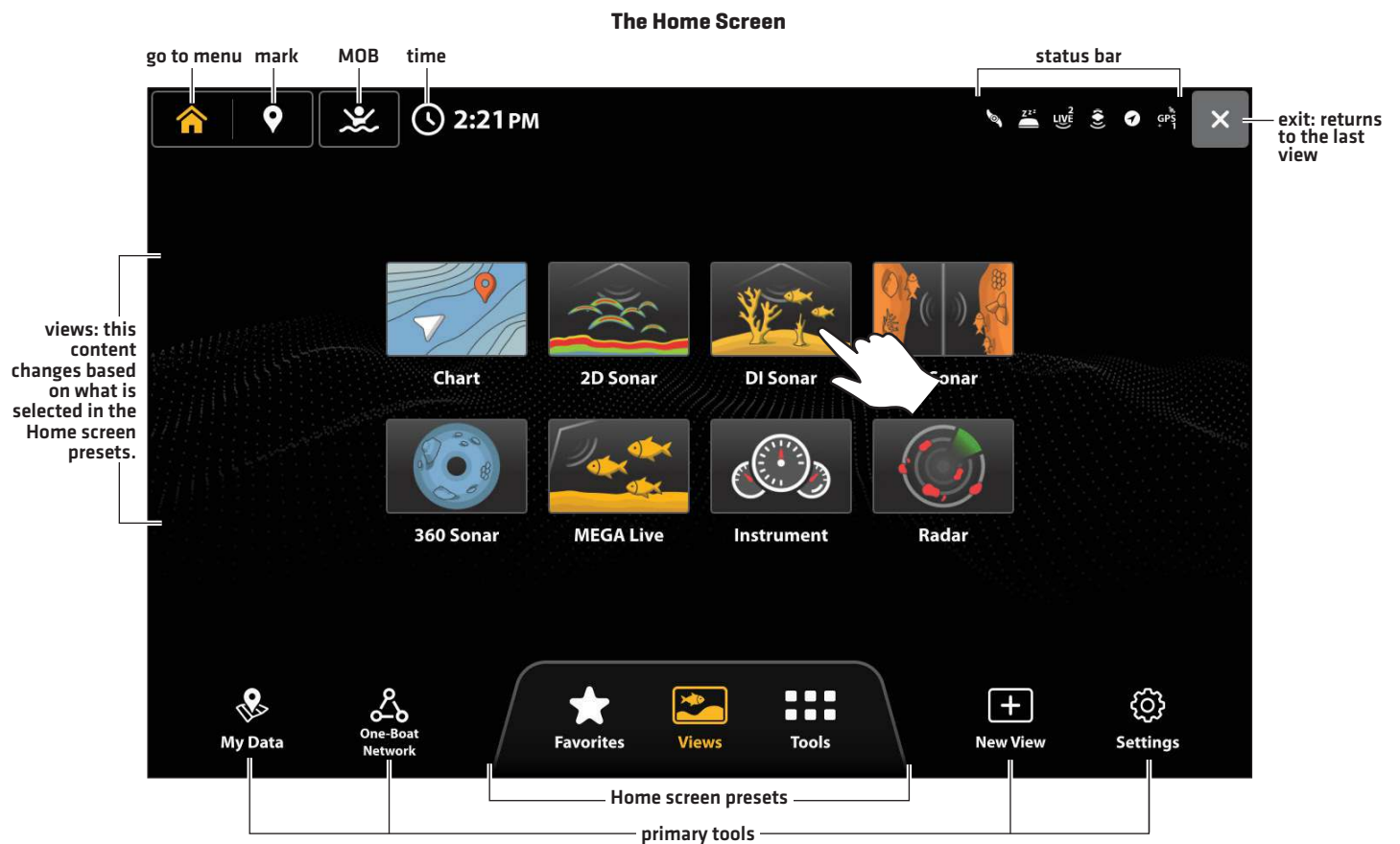

Swipe down to open from any view









OR

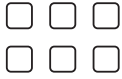

Press the HOME key









Navigate the Home Screen

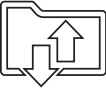

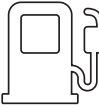

Use the touchscreen to select an option from the Home screen.

Icon	Name	Function
	Views	Select Views to access the complete set of views available on your fish finder. You can edit views, create your own views, and save your favorite views. See Views for more information.
	Favorites	Select Favorites to quickly access your favorite saved views. Favorites are displayed on the Home screen and the Side Bar. See Views for more information.
	Tools	Tools allow you to manage the fish finder network operations and saved data. When you connect an accessory to the fish finder, a related tool may also be displayed.
	My Data	Select My Data to manage your saved waypoints, spot-locks, routes, tracks, and ittracks. You can create new navigation data from this screen or edit your saved navigation data [see Manage your Navigation Data]. Required Equipment: GPS receiver [internal or external]
	One-Boat Network	Select One-Boat Network to pair your fish finder to the One-Boat Network App on your mobile phone. See Getting Started . You can also pair your wireless remote, trolling motor, shallow water anchor and downrigger [separate purchase required] to the fish finder. See your installation guide for details. Required Equipment: mobile phone [with Bluetooth]
	New View	Select New View to create a new view from a blank template. You can change the type of data displayed in a view and how many panes are displayed [see Create a New View].
	Settings	Select Settings to change general system settings such as the units of measurement and the time and date format. You can also use this menu to view system, network, and NMEA 2000 information. See each related section of this manual for details.
	Waypoint	Select Waypoint to add a waypoint. Waypoints can be added at the boat position or cursor position.
	MOB	Select the MOB icon to start Man Overboard functions. See MOB for more information.

Tools

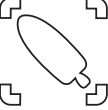
Tools allow you to manage the network operations and saved data. When you connect an accessory to the fish finder, a related tool may also be displayed.

Icon	Name	Function
	Alarms	Select Alarms to view the alarm log, mute alarm sounds, and set the alarms for the individual applications. To set up individual alarms for navigation, sonar, radar, AIS, etc., see each related section of this manual for details.
	Software Updates	Select Software Updates to update the software for the fish finder or connected accessories. See the following sections: Manage your Navigation Data and Manage your Fish Finder .
	Navionics	Select Navionics to access advanced mapping features. Required Map Source: Navionics
	Sun + Moon	Select Sun + Moon to review the sunrise and sunset for today or the date you select. The Moon data provides the rise and set of the moon and moon phases. Required Map Source: Navionics or CoastMaster VX.
	Images	Select Images to manage your screen snapshots. When a screen snapshot is taken, a waypoint can also be saved at the current position. You can also choose to save the image on the fish finder or to an SD or microSD card. See Images Tool for more information.
	Fuel	Select Fuel to review the fuel log for NMEA 2000 fuel sensors connected to the network. This tool provides refuel alerts and displays the fuel level in graphical form. See Set up a NMEA 2000 Network for details. Required Equipment: NMEA 2000 tank sensor and/or fuel flow rate sensor
	Trip Log	Select Trip Log to display Speed over Ground (SOG), timer for elapsed time, distance traveled since last reset, average speed, and trip fuel. You can also reset the trip log to zero and review trend data from this tool. Required Equipment: GPS receiver [internal or external]
	Timer	Select Timer to set an alarm clock for a selected time of day, use the countdown timer, or use the stopwatch. You can set more than one alarm clock.
	GPS	Select GPS to review the signal strength of the GPS receivers (“sensors”) connected to the system. The tool shows the satellites in the area, the positions, and the signal strength for each one. You can also designate a primary and secondary GPS source from this tool. See Getting Started, Installation Information, and Set up your Humminbird Network . Required Equipment: GPS receiver [internal or external]

Icon	Name	Function
	<p>Record</p>	<p>Select Record to start a sonar recording or select a save location. You can also watch a sonar recording from the perspective of a 2D, SI, or DI View, depending on the capabilities of your model. See Sonar Recording for more information.</p> <p>Required Equipment: transducer</p>
	<p>Targets</p>	<p>Select Targets to manage AIS and MARPA targets.</p> <p>Required Equipment: AIS or Radar, GPS receiver (internal or external), and compass/heading sensor</p>
	<p>Tides</p>	<p>Select Tides to review information for the nearest tide station to your present position. The tool includes the position of the station and the times of the high and low tides for today's date. A tide graph is also displayed showing the rise and fall of the tides for the 24 hour time period encompassing the date. You can also search data for a selected date.</p> <p>Required Map Source: Navionics or CoastMaster VX.</p>
	<p>Currents</p>	<p>Select Currents to review information for the nearest current station to your present position. Two graphs are also presented that show the time, direction, and flow speed of the current changes for the 24 hour time period of today's date. You can also search data for a selected date.</p> <p>Required Map Source: Navionics or CoastMaster VX.</p>
	<p>Battery Monitoring</p>	<p>Select Battery Monitoring to see real-time readings of battery power, remaining runtime and low-battery alerts.</p> <p>Required Equipment: Minn Kota QUEST Series trolling motor.</p>
	<p>Audio</p>	<p>Select Audio to control audio from the fish finder.</p>

THE MENU SYSTEM

The Humminbird fish finder provides menu options that change with the application, on-screen view, and the operations mode.

Open Settings

The Settings tool provides main menu settings for the fish finder.

1. Press the HOME key.
2. Tap Settings.

Selecting Settings

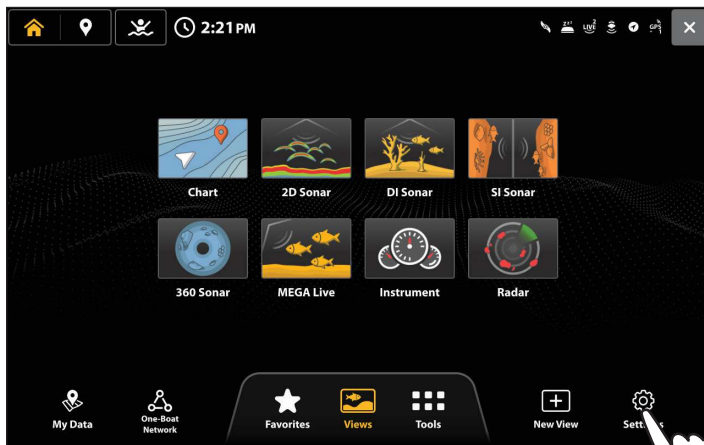

Viewing Settings

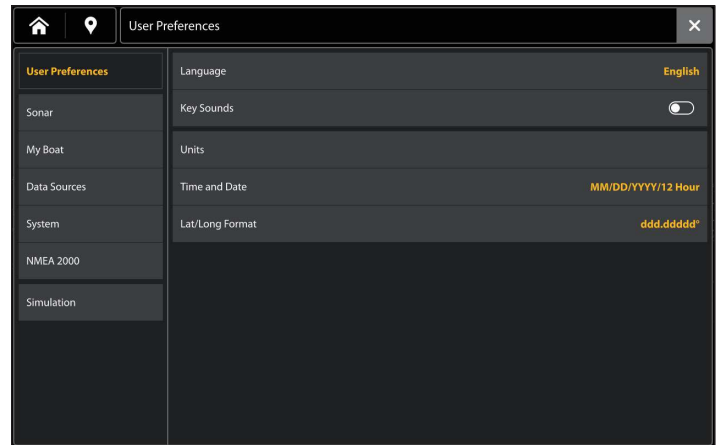

Additional Keypad Option

With a view displayed on-screen, press and hold the MENU key.

Top Bar

The Top Bar is located at the top of each View screen. It changes to match the on-screen view and operation mode.

In the following illustration, the information in the Top Bar corresponds with the Chart View displayed on-screen. You can tap an icon in the Top Bar to open a menu, return to the Home screen, close a menu, or make a selection. You can also use the corresponding keys.

Top Bar

touch menus change to match the on-screen view and status

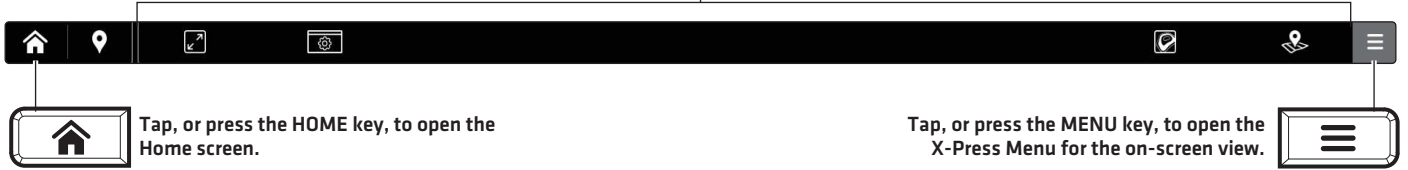

Chart View Status Bar Menus

Chart View Top Bar



Sonar View Status Bar Menus

Sonar View Top Bar



See each View section for more information on the available Top Bar functions for each view.

Open an X-Press Menu

The X-Press Menu displays menu options for the on-screen view and operation mode (such as navigation). In a multi-pane view, the X-Press Menu options are determined by which pane is selected. See **Views** for more information.

Open an X-Press Menu

1. With a view displayed on-screen, tap the Menu icon in the Top Bar.

OR

Press the MENU key.

Open an X-Press Menu in a Multi-Pane View

1. With a Multi-Pane View displayed on-screen, tap a pane.
2. Tap the Menu icon in the Top Bar, or press the MENU key.

Opening an X-Press Menu for a Selected Pane

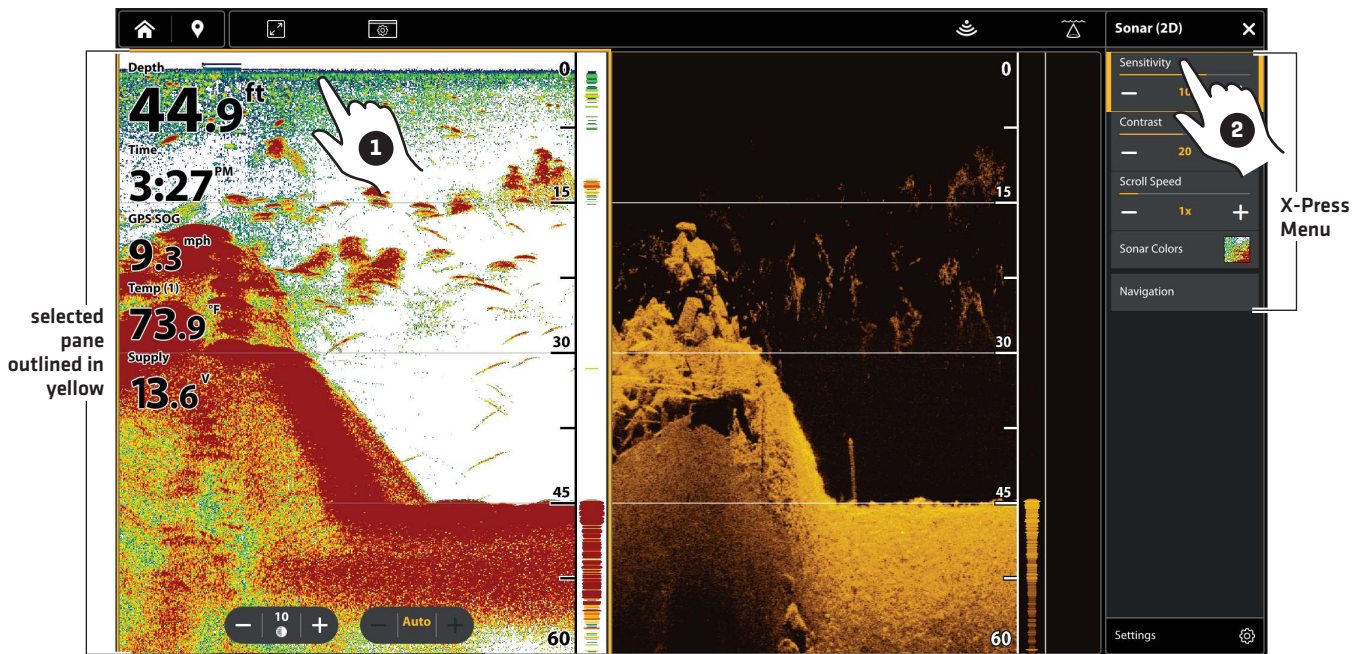

Tap to Select a Pane
and the Menu

OR



Press the MENU key

Change a Menu or Start an Action

Use the following instructions to change a menu setting or start an action through the menu system.

1. Tap a menu category, or use the Cursor pad or Joystick to select it.
2. Adjust the setting or start an action using the touch screen or keys. See *Tips for Changing a Menu*.

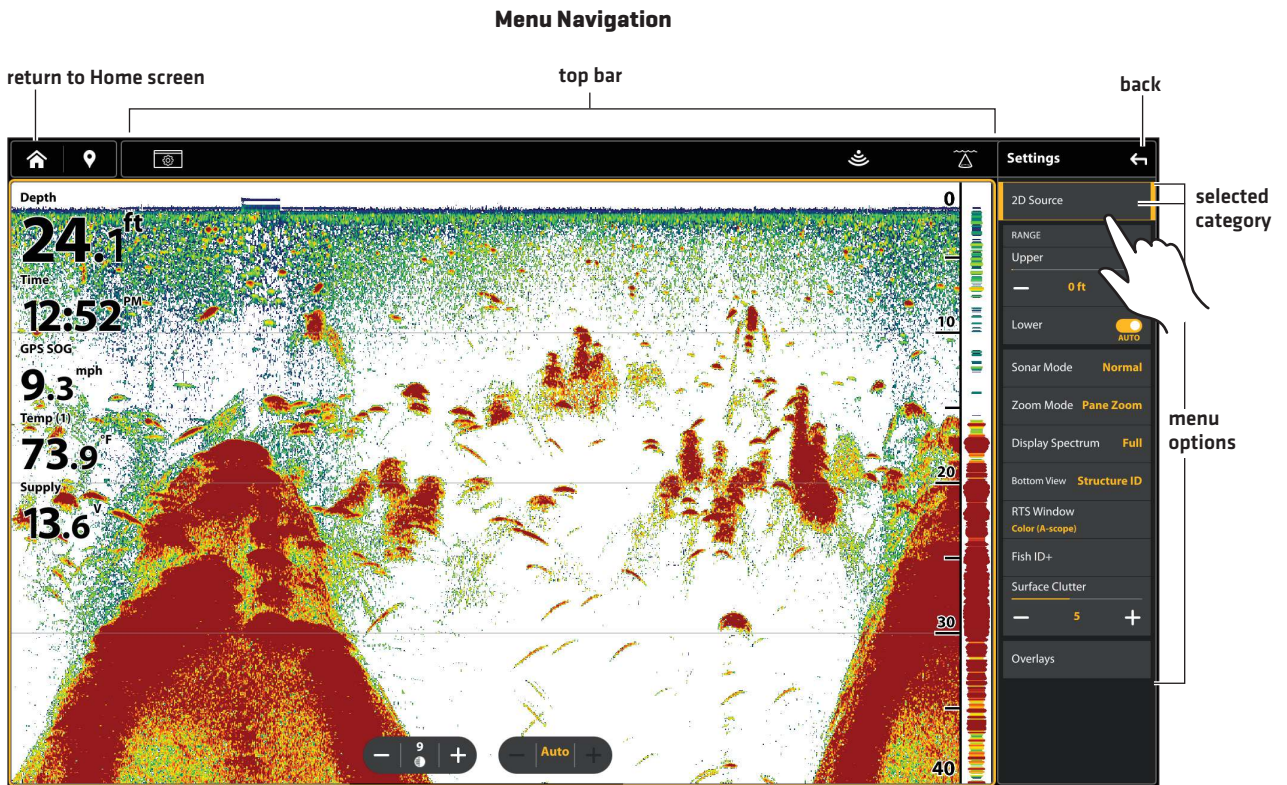

Tips for Changing a Menu

This section describes the different types of menus in the menu system and how to change them using the touch screen or keypad.

Action (>)

Touch Screen

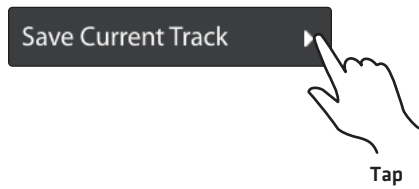

Keypad



Press

On/Off Button

Touch Screen

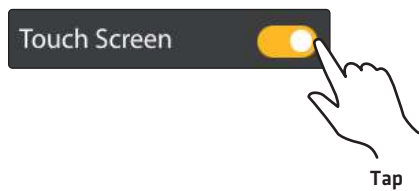

Keypad



Press

Slider

Touch Screen

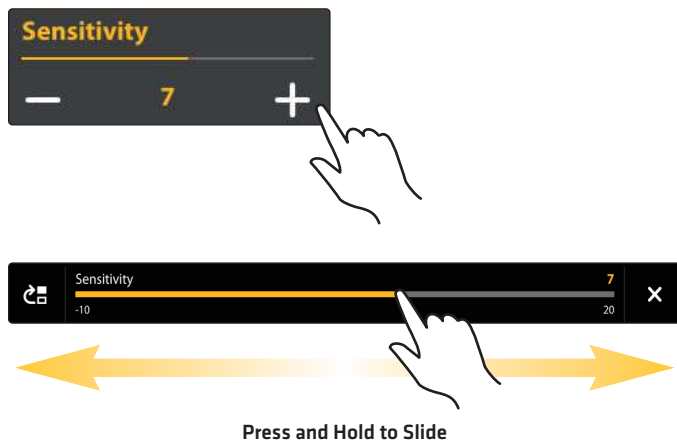

Keypad



Press

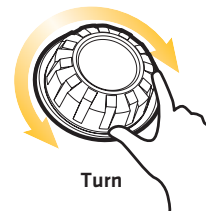

APEX/SOLIX:
You can also use the Rotary Dial.

Pick List or Check Box

Touch Screen

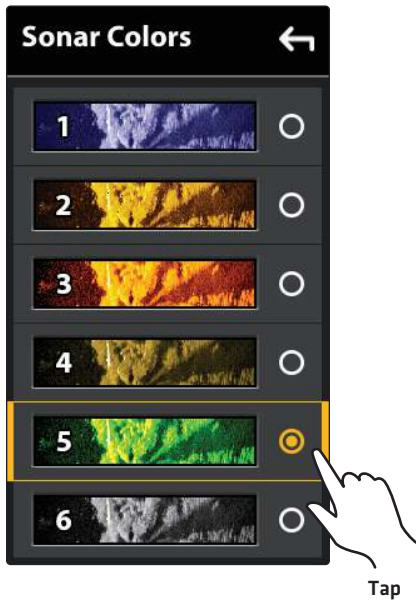

Keypad

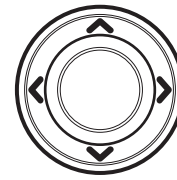

XPLORE:
Use the Cursor Pad to make a selection and then press the ENTER key.

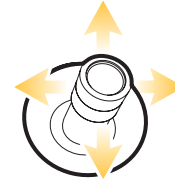

APEX/SOLIX:
Use the Joystick to make selections.

Tips for Using the On-Screen Keyboard

Use the on-screen keyboard to rename the fish finder in the network, edit your navigation data, and more.



Close a Menu

When you close a menu, your settings are saved until you change them again or until the fish finder defaults are restored.

1. **Back:** Tap the Back icon  to close the current menu and go back one level in the menu system.

OR

Press the EXIT key.

2. **Close:** Tap the X icon .

OR

Press the EXIT key. To close several menus at once, press and hold the EXIT key.

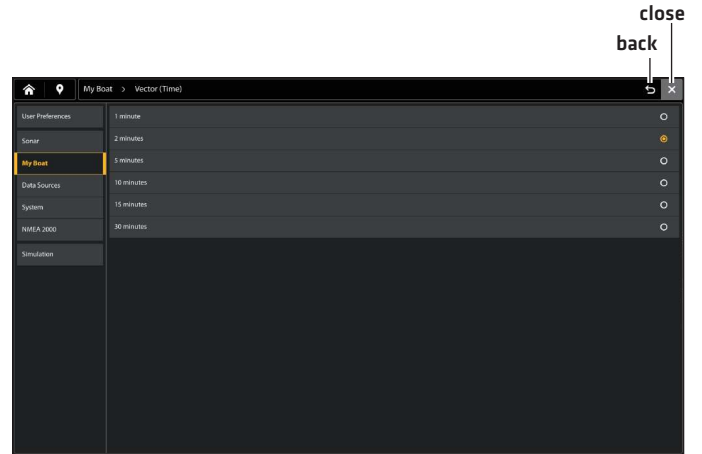

Side Bar Widgets

The Side Bar includes widgets that allow you to quickly access your favorite views, data bars, and digital remotes for networked accessories, like the Advanced GPS Wireless Remote, Talon and Raptor.





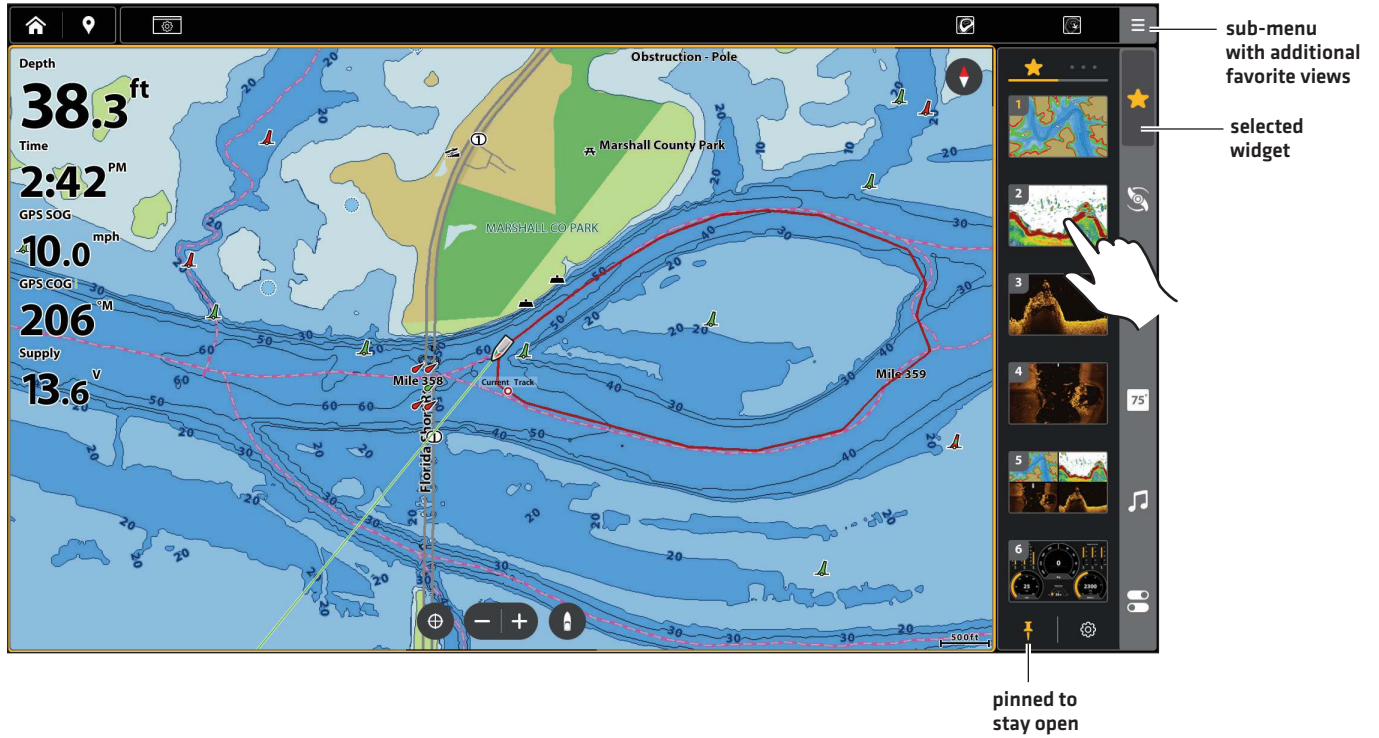

The Side Bar is set to be minimized. Tap the Side Bar to view the widgets and tap the Pin icon to keep the Side Bar open. See *Edit the On-Screen View: Turn the Side Bar On/Off*.

Opening a Widget



Available Side Bar Widgets

When you connect an accessory to the fish finder, a related widget may also be displayed in the Side Bar.

Icon	Name	Function
	Favorite Views	Allows you to create a list of your favorite views. There are two tabs of favorite views. Use the widget to quickly display your favorite views [see Views]. These favorites are linked to the favorites selected from the Home screen.
	Data Bar	Displays the standard Data Bar with data box readouts. There are two tabs and each data box can be customized [see Views: Understand the Data Box Digital Readouts].
	Trolling Motor*	Displays the trolling motor digital remote.
	Talon*	Displays the Talon digital remote, which includes quick access menus to deploy and retract the Talon, change the anchor mode, turn the work light on/off, etc.
	Raptor*	Displays the Raptor digital remote, which includes quick access menus to deploy and retract the Raptor, change the anchor mode, and adjust deployment speed.
	Audio*	Displays the audio settings for a connected audio accessory.
	Audio Fusion*	Displays the audio settings for a connected Fusion radio accessory.

*separate purchase accessory

VIEWS

There are many options to display data on-screen, and the data can be displayed in a variety of ways. You can open a view from the Views tool or from the Favorites tool. You can also create a new view, edit views, and customize your favorite views list.

Display a View from the Views Tool

The Views tool includes the complete database of available views for your fish finder.

1. Press the HOME key.
2. Tap the Views tool.
3. Tap a View group.
4. Tap a View to display.

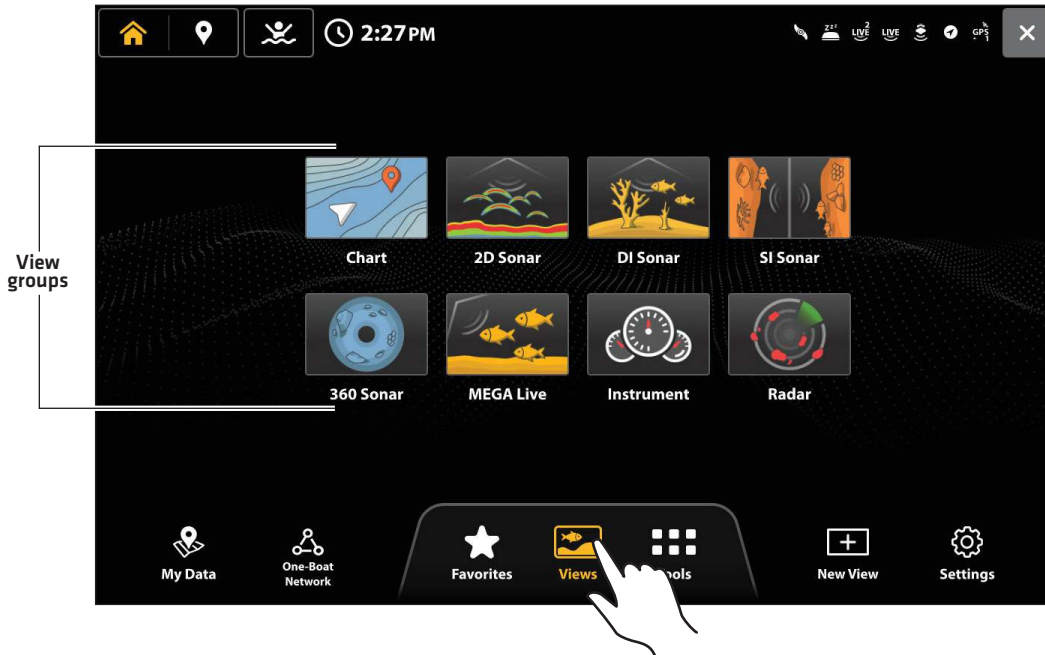

Opening a View from the Views Tool

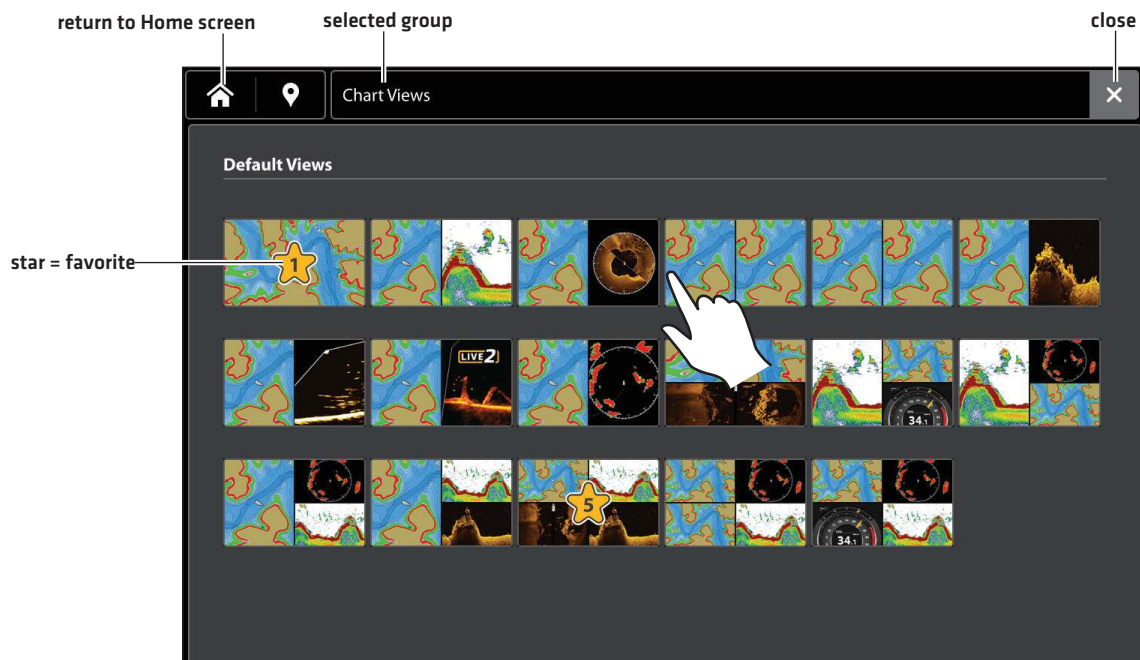

Display a View from the Favorites Tool

The Favorites tool displays all of your saved favorite views for your fish finder. Use the Favorites tool to edit your favorite views at any time.

1. Press the HOME key.
2. Tap the Favorites tool.
3. Tap a Favorite View to display

OR

4. Tap an open box to select a new favorite from the groups of views or create a new view.

Opening a View from the Favorite Views Tool

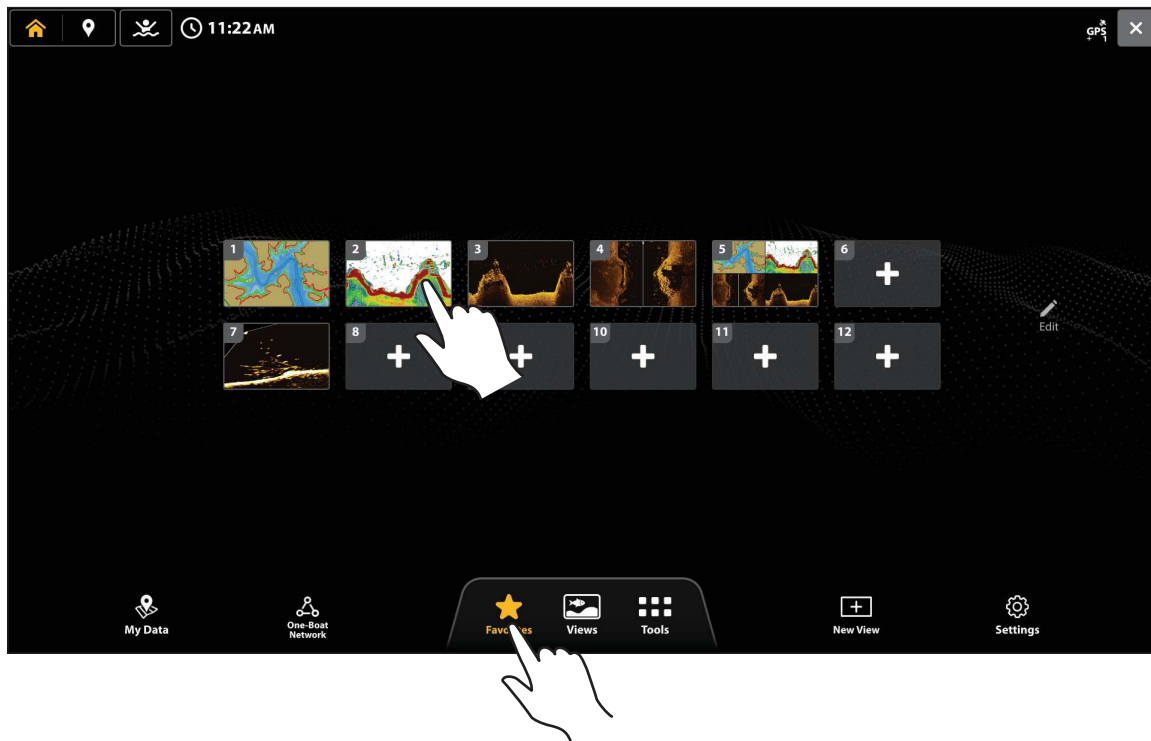

Save a View to the Favorites Tool

1. Press the HOME key.
2. Open the Favorites tool.
3. Tap an open box or select Edit.
4. Tap a View Group.
5. Tap a View to display.
6. Favorites seen on the Home Screen and within the Side Bar are the same.

Saving a New Favorite View

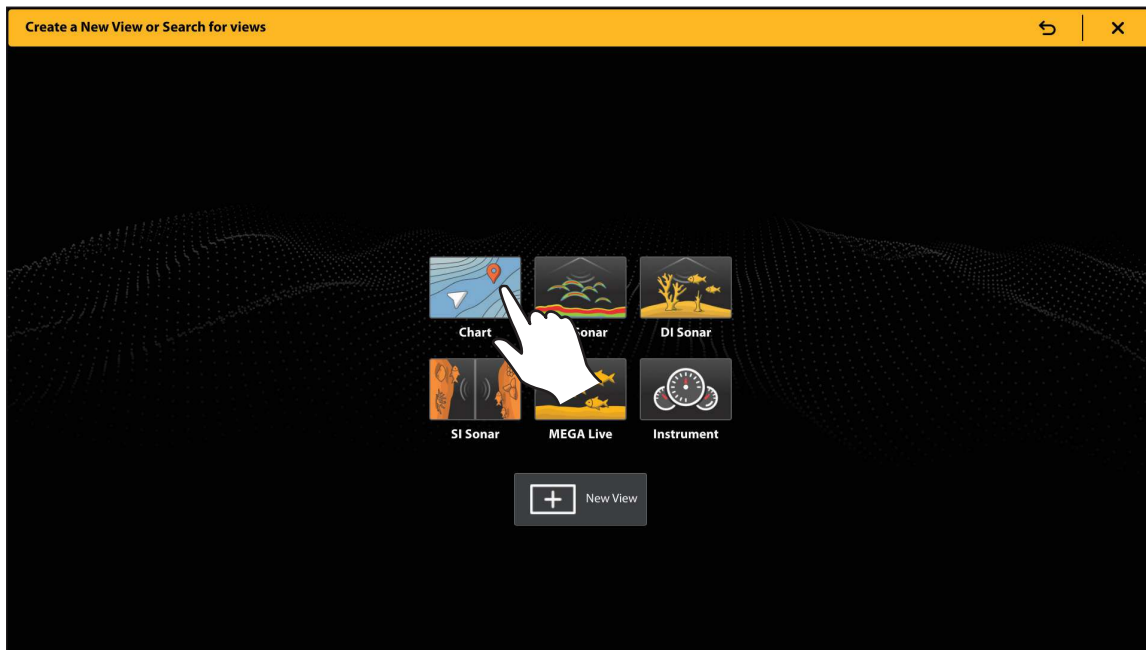

Display a View from the Favorites Side Bar

1. With a View displayed on screen, tap the Favorites icon in the Side Bar.
2. Tap a view to display.

Opening a View from the Favorite Views Widget

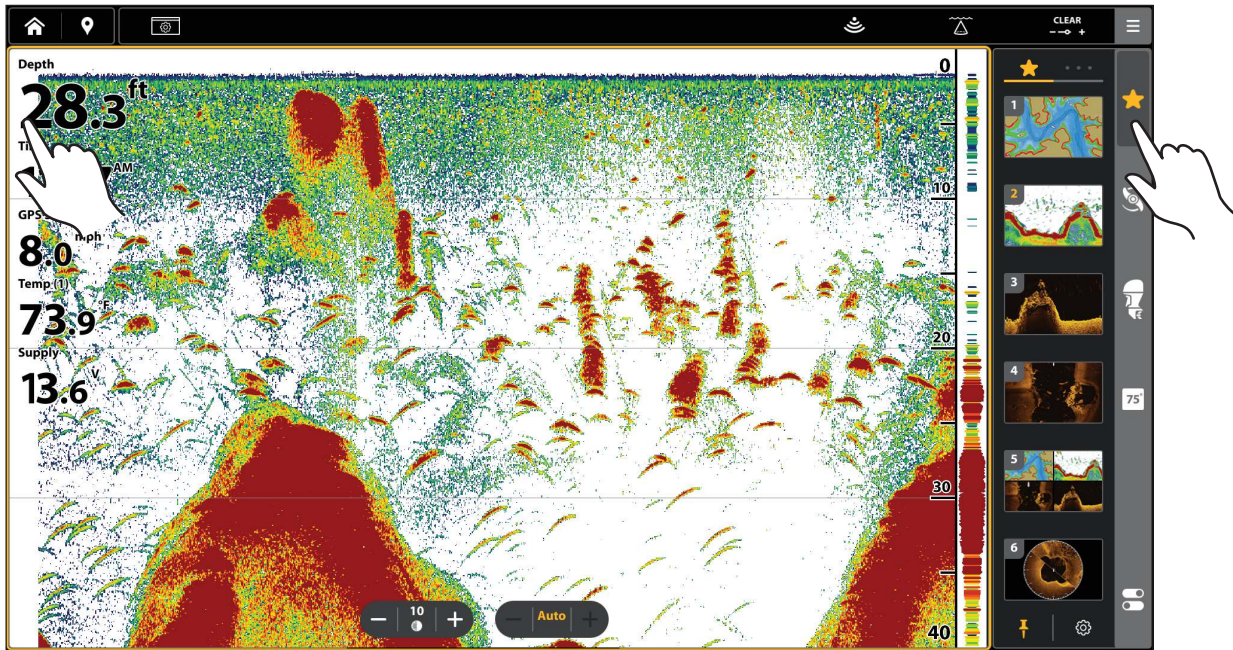

Save a Favorite View to the Side Bar

1. Press the HOME key.
2. Open the Views tool.
3. Select a view to display.
4. Once the view is displayed, tap the Favorites widget in the Side Bar.
5. Select the position in the Favorites list to save the displayed view. Press and hold an existing Favorite View to replace it, or tap the plus icon to save the new view to an open box [the number of views that can be saved is determined by your fish finder model].

Create a New View

Customize your own view using the New View tool. Use the New View tool to change the type of data that is displayed in the view and how many panes are displayed.

1. Press the HOME key.
2. Select New View.
3. Select a Pane Layout from the Layout tab.
4. Tap a circle to adjust the pane size.
5. Tap a pane to highlight it, and select an application from the Application tab.
6. Repeat Step 5 for each pane.
7. Tap Save.

Selecting a Pane Layout

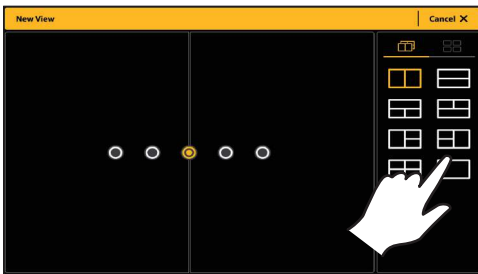

Selecting the Application Type

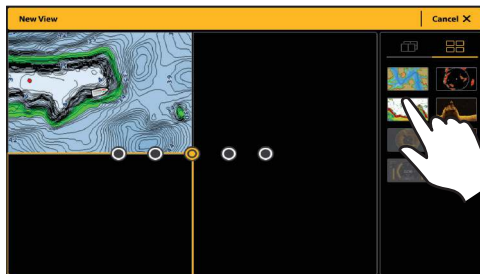

Saving the View

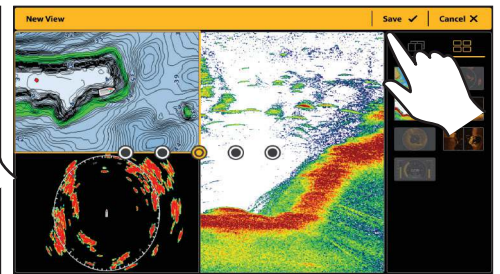

THE VIEW OPTIONS MENU

The **View Options** menu provides options to edit the selected view.

Open the View Options Menu for the On-Screen View

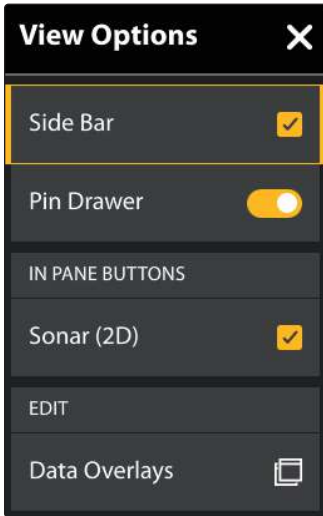

1. With a View displayed on-screen, tap the View Options button  on the Top Bar.

Turn the Side Bar On/Off

You can turn the Side Bar on or off using the View Options menu. Set the Side Bar to stay displayed to view live data along with the display, or close the Side Bar to view more of the display.

You can customize the data boxes displayed in the data bars. See [Edit the On-Screen View](#).

1. With a View displayed on-screen, tap the View Options button  on the Top Bar.
2. Select Side Bar.
3. Tap, or press the ENTER key, to change the setting. [check mark = visible, blank = hidden]

Sonar View [with Side Bar Set to On]

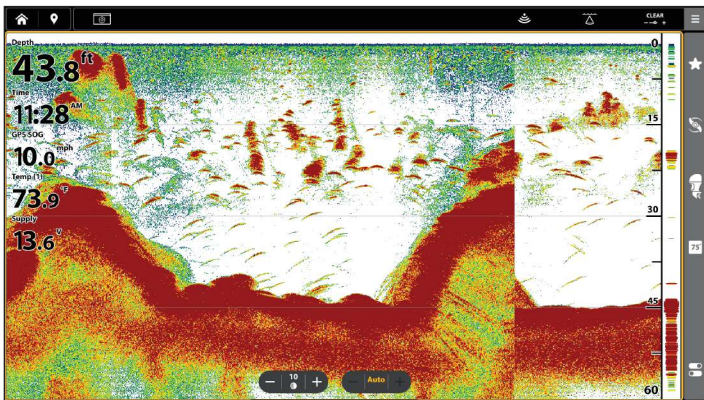

Sonar View [with Side Bar Set to Off]

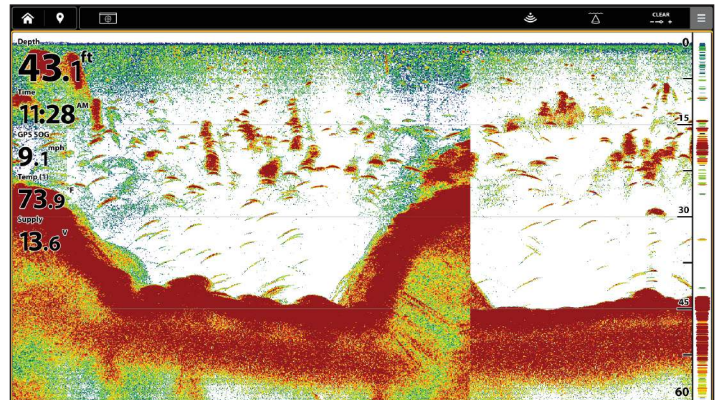

Pin the Side Bar Open

The Side Bar is set to minimize unless it is pinned open. There are two options to pin the Side Bar.

1. With a View displayed on-screen, tap the View Options button  on the Top Bar.
2. Select Pin Drawer.
3. Tap the on/off button, or press the ENTER key, to change the setting.

OR

1. With a View displayed on-screen, tap the Side Bar to open it.
2. Tap the Pin button at the bottom of the screen.

Pin the Side Bar

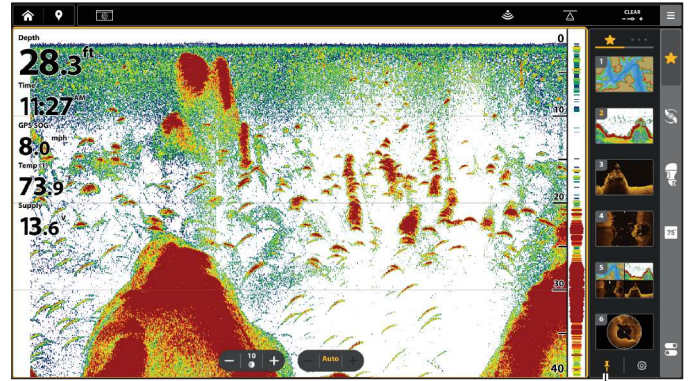

select to keep the Side Bar displayed (otherwise, it will automatically close)

Turn the In Pane Buttons On/Off

Each View has In Pane Buttons for quick setting adjustments. Use the View Options menu to turn the In Pane Buttons on or off.

1. With a View displayed on-screen, tap the View Options button  on the Top Bar.
2. Select In Pane Buttons.
3. Tap, or press the ENTER key, to change the setting. [check mark = visible, blank = hidden]

Display Data Overlays

Digital readout data can be displayed as an overlay, and it can be displayed in the data bar. To turn on the data bar, see the next section *Display a Data Bar*.

Display an Overlay on the View

1. With a View displayed on-screen, tap the View Options button  on the Top Bar.
2. Select Data Overlays.
3. **Turn On Data Overlays:** Select Overlay. Tap the on/off button, or press the ENTER key, to turn it on.
4. **Select a Data Overlay Preset:** Under Preset, select the type of data overlay.

There are presets grouped for certain functions [Sonar, Chart, Navigation], and presets grouped by position, size and color [Overlay 1 through Overlay 6].

For example, to display navigation data like Heading, Course Over Ground [COG], Speed, etc., select Navigation.

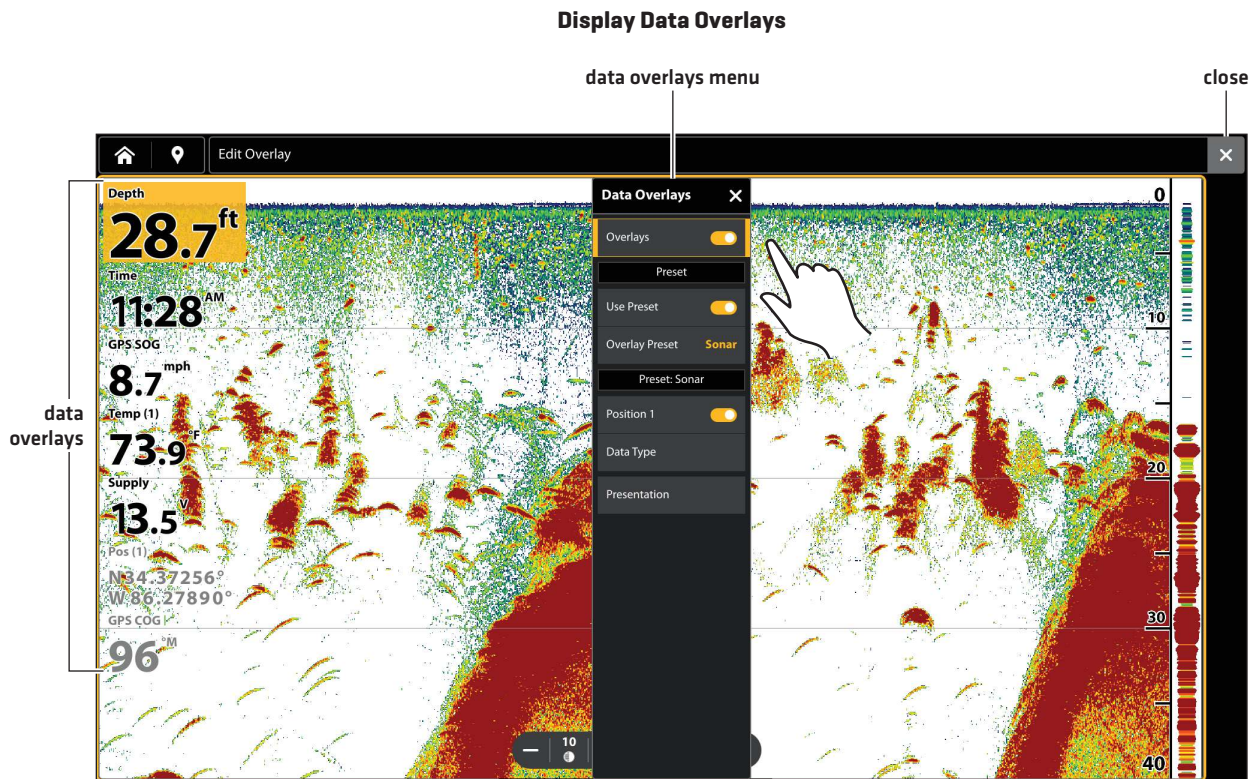

Change the Overlay Data

Use the following instructions to customize the data displayed in the data overlay. You can also change the overlay color, size, and position on the view.

1. Open the View Options menu, and select Data Overlays.

OR

Press and hold an overlay.

2. Select to edit a Preset or a Custom overlay. Any changes to the selected overlay will be applied to other views.
3. Tap an overlay position to change. The data box will be highlighted in yellow, and the position will be updated on the Data Overlays menu.
4. Tap Data Type.
5. Select the new data category.

To turn the readout off, tap the on/off button by the Position.

6. Select the data type.
7. Tap the Back button.
8. **Repeat:** Repeat steps 4 through 8 to change more data overlays.

OR

Close: Press the EXIT key until the menu is closed.

Selecting an Overlay Position

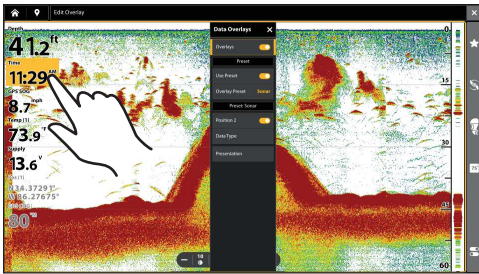

Selecting the Data Type

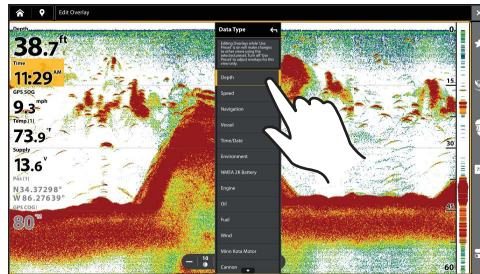

Selecting the Data

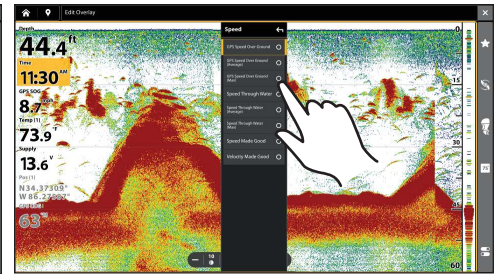

Turning an Overlay On/Off

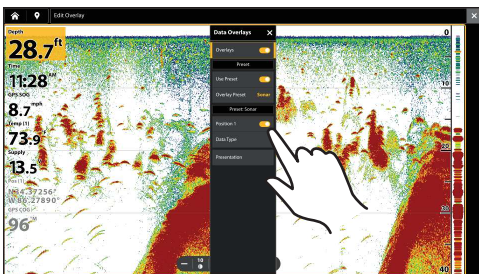

Change the Overlay Appearance

You can also change the overlay color, size, and position on the view.

1. Open the View Options menu.
2. Select Data Overlays.
3. Select Presentation.
4. Set the following menus to your preference:

Overlay Position	Change the position of the overlay on the screen.
Overlay Size	Change the font size.
Overlay Color	Change the font color.

5. **Back:** Tap the Back icon to return to the previous menu.

OR

Close: Press the EXIT key until the menu is closed.

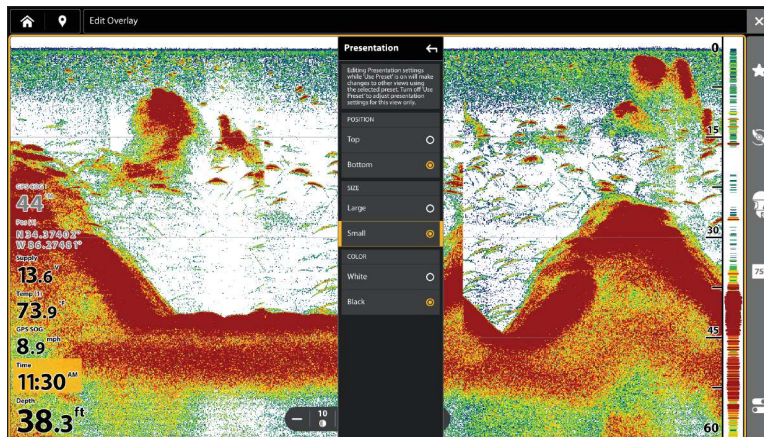

Changing the Data Overlay Presentation



Display a Data Bar

Your fish finder allows you to display a data bar with preset data boxes. The data boxes in the data bar can also be changed. To turn on the data overlay, see the previous section *Display Data Overlays*.

Display a Data Bar

1. With a view displayed on-screen, tap the Side Bar to expand it.
2. Select the Data Bar icon  from the Side Bar. Tap the More icon  to see the second tab in the data bar.

To keep the data bar displayed on the view, tap the pin icon at the bottom of the data bar.

Displaying a Data Bar

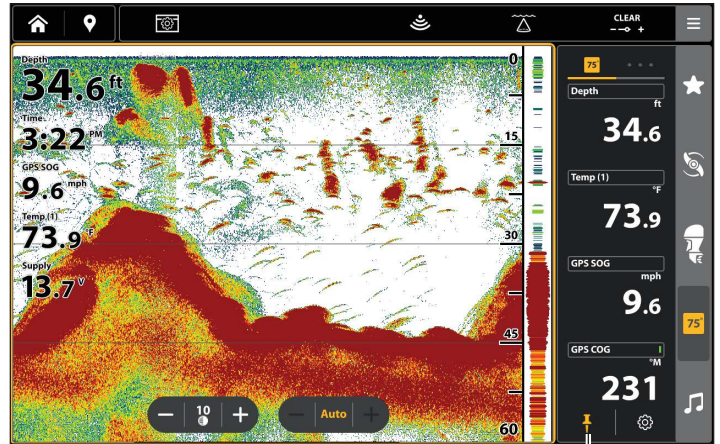
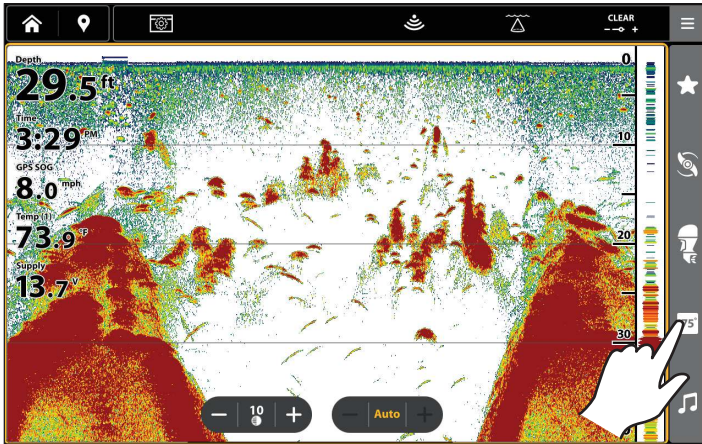

select to keep the data bar displayed (otherwise, it will automatically close)

open the second tab to see more digital readout boxes

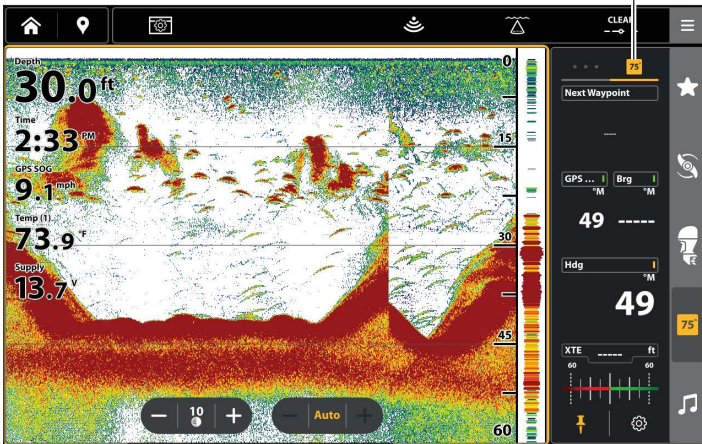

Change the Data Boxes

Use the following instructions to change the data boxes displayed in a data bar.

1. With a view displayed on-screen, tap the Side Bar to expand it.
2. Select the Data Bar icon  from the Side Bar.
3. Press and hold the data box to select it.
4. Select a data type from the menu.
5. Select a data label.
6. **Close:** Press the EXIT key.

Selecting a Data Box

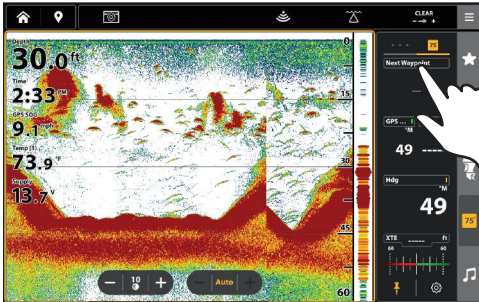

Selecting the Data Type

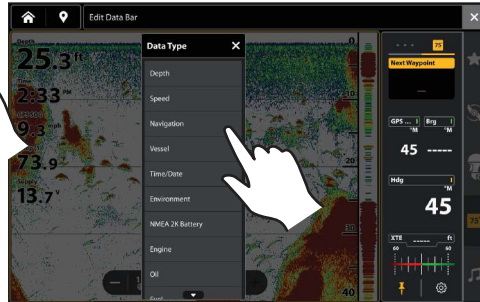

Selecting the Data Label

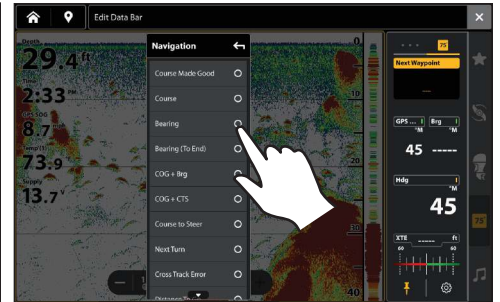

Understand Data Box Digital Readouts

The table below displays the basic data box options that are shown in the Standard data bar and the Navigation data bar, as well as the additional data box options for vessel, wind, and engine. The data box options are determined by the installed equipment and the selected sources on the network. Your fish finder provides a wide variety of data box options, more than the information shown here.

The number on the data label [Temp 1, Temp 2, Temp 3, etc.] corresponds with the source number. For more information about sources and networking, see *Installation Information*, *Set up your NMEA 2000 Network*, and *Set up your Humminbird Network: Select Data Sources*.

Label	Name	Description	Data Type
Alt	Altitude	The height measurement above sea level.	Vessel
AWA	Apparent Wind Angle	The direction of wind relative to the bow of the vessel.	Wind
AWS	Apparent Wind Speed	The speed of wind with respect to the speed of the vessel.	Wind
Brg	Bearing	The compass direction from the vessel position to the next waypoint or route point.	Navigation
Brg [End]	Bearing [To End]	The compass direction from the vessel position to the final point in a route.	Navigation
Course	Course	The intended direction of travel measured between the start point and end point.	Navigation
CMG	Course Made Good	The bearing from your starting position to the present vessel position. The goal is to have CMG and Track equal to the same number.	Navigation
COG	Course Over Ground	The current direction the boat is traveling measured in degrees from North. When the COG is equal to Bearing, the boat is said to be on course and will arrive at the destination in the most efficient manner.	Vessel
CTS	Course to Steer	The heading that must be maintained in order to reach the planned destination.	Navigation
Depth [#]	Depth	The depth of the water from the transducer or digital depth sensor to the bottom. This measurement includes the depth offset setting.	Depth
Dest Wpt ID	Next Waypoint	The next point [waypoint, route point, Man Overboard point, etc.] that the vessel is navigating towards in a route or other navigation mode.	Navigation
DBT	Depth Below Transducer	The depth of the water below the transducer. This measurement does not include the depth offset setting.	Depth
DMG	Distance Made Good	The straight line distance actually traveled between the start position to the current vessel position.	Navigation
DTG	Distance to Go	The distance between the vessel position and the next waypoint or route point.	Navigation
Eng Temp [#]	Engine Temperature	The engine temperature from the engine source.	Engine
Eng Volt [1]	Engine Voltage	The power supplied to the engine source.	Engine
ETA	Estimated Time of Arrival	The estimated time of arrival to the next waypoint on the route.	Navigation

Label	Name	Description	Data Type
Fuel [#]	Fuel Level	The fuel level of the fuel source.	Fuel
Hdg	Heading	The direction the boat is pointing, measured in degrees. Due to wind and waves, the boat is often traveling in a slightly different direction than its heading. See Course Over Ground [see COG].	Vessel
Heat Index	Heat Index	The perceived temperature derived from air temperature and relative humidity.	Environment
Next Turn	Next Turn	The course of the next route leg with respect to the current heading.	Navigation
Odo	Odometer	The distance traveled.	Vessel
Pitch	Pitch	The rotation angle of the boat from front to back [bow to stern].	Vessel
Position [#]	GPS	The latitude and longitude coordinates of the vessel position based on the GPS receiver installation location.	Vessel
Roll	Roll	The rotation angle of the boat from side to side [port to starboard].	Vessel
ROT	Rate of Turn	The rate at which the boat is turning, measured in degrees per second.	Vessel
RPM	Revolutions Per Minute	The number of engine revolutions per minute.	Engine
SMG	Speed Made Good	The distance from the starting waypoint on the route divided by the time elapsed since starting navigation on the route.	Speed
SOG	Speed Over Ground	The measurement of the boat's progress across a given distance and the speed measurement provided by GPS. SOG is optimal for navigation because accurate destination times can be derived from this measurement.	Speed
STW	Speed Through Water	The measurement of the flow past the boat, which may vary depending on current speed and direction.	Speed
Temp [#]	Water Temperature	The detected water temperature.	Environment
Temp [Air]	Air Temperature	The detected air temperature.	Environment
TTG	Time to Go	The estimated time required to reach the next waypoint on the route. TTG is calculated using the SOG [Speed Over Ground] and DTG [Distance to Go].	Navigation
TWA	True Wind Angle	The wind angle detected when the vessel is stationary.	Wind
TWS	True Wind Speed	The wind speed detected when the vessel is stationary.	Wind
VMG	Velocity Made Good	The speed of travel relative to the next waypoint on the route.	Speed
XTE	Cross Track Error	The straight-line distance of the boat from the intended Track. XTE measures how far the boat is off course.	Navigation

Edit the On-Screen View

When you edit an on-screen view, the options are displayed in the X-Press menu. These view options are dependent on the selected view, and each one is described in detail in each section. For example, for Sonar Overlay settings, see **Sonar Overview**.

The menu options are determined by the type of view on-screen, and there are many options for each view. For example, in a Sonar View, you can choose the palette, turn on Fish ID+, display or hide the Real Time Sonar Window, and more.

1. With a View displayed on-screen, tap the Menu icon, or press the MENU key once.
2. Select Settings.
3. Use the touch screen or Cursor pad/Joystick to select a menu and change a setting.

Changing the Sonar View Palette

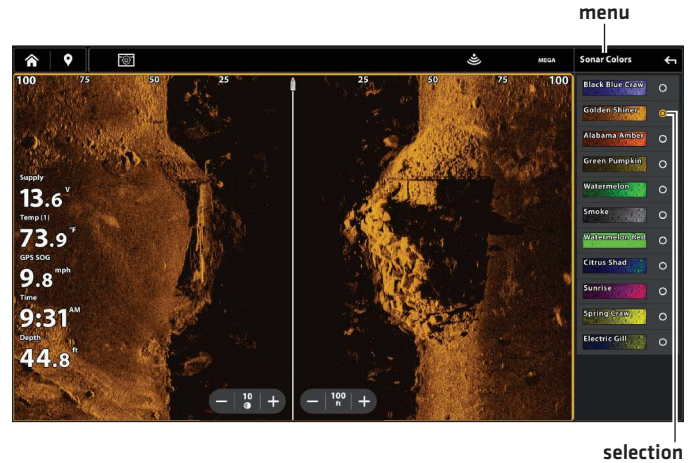

Change the View Overlays

Use the Overlays menu to display or hide information on the view. For example, in a Chart View, you can display or hide the vessel icon, and you can choose which navigation data [waypoints, routes, tracks, etc.] you want to display on the view.

1. With a View displayed on-screen, tap the Menu icon, or press the MENU key once.
2. Select Settings.
3. Select Overlays.
4. Use the touch screen, or the Cursor pad and Enter key, to select a menu and change a setting. [check mark = visible, blank = hidden].

SET UP AN INSTRUMENT VIEW

The Humminbird fish finder provides Instrument Views in a variety of combinations to display on-screen. You can also customize the gauges, data boxes, and ranges.

NOTE

The data boxes and gauges must have input from connected and powered equipment. The Engine data boxes must have input from a NMEA 2000 network to provide source data. For more information about sources and networking, see *Installation Information, Set up your NMEA 2000 Network, and Set up your Humminbird Network*.

Instrument View

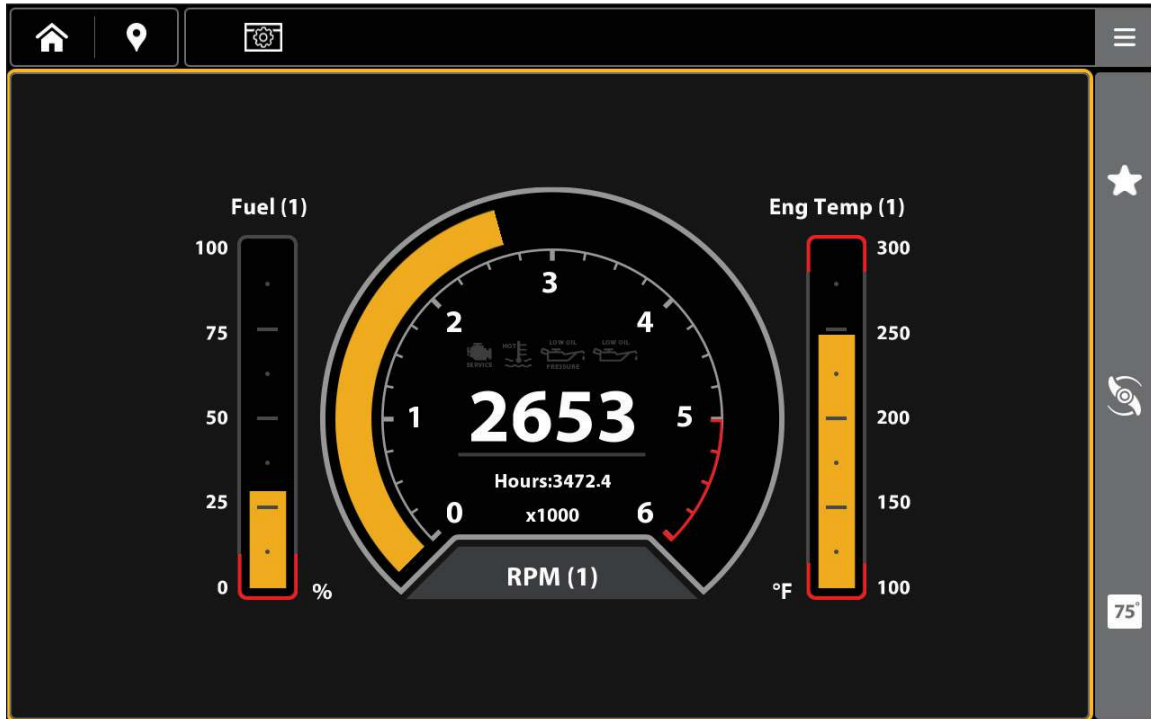

Display an Instrument View

1. Press the HOME key.
2. Select the Views tool.
3. Under Groups, select Instrument.
4. Tap an Instrument View.

Customize an Instrument View

In an Instrument View, you can customize the gauges, data boxes, and ranges. You can change each item in the same way you change data boxes in a view. You can also set up warning limits for the selected data range.

NOTE

The available changes and sources are determined by the selected gauge or data box. As you change data, the available sources are displayed in white, and the unavailable sources are displayed in black.

1. With an Instrument view displayed on-screen, tap the Menu icon, or press the MENU key once.
2. Select Edit Instrument.
3. Tap a gauge or data box.
4. **Change the Type of Data:** Select Data Type. Select a category and a data type from the menus.
5. **Change the Displayed Range and Warning Threshold:** Select Data Limits. Select a range from the list.

Select a warning (if available), and tap the on/off button to turn it on. Tap the +/- buttons or press the +/- ZOOM keys to set the warning threshold.

6. **Close:** Press and hold the EXIT key.

Selecting a Data Box or Gauge

Selecting a Data Type

Selecting a Data Limit

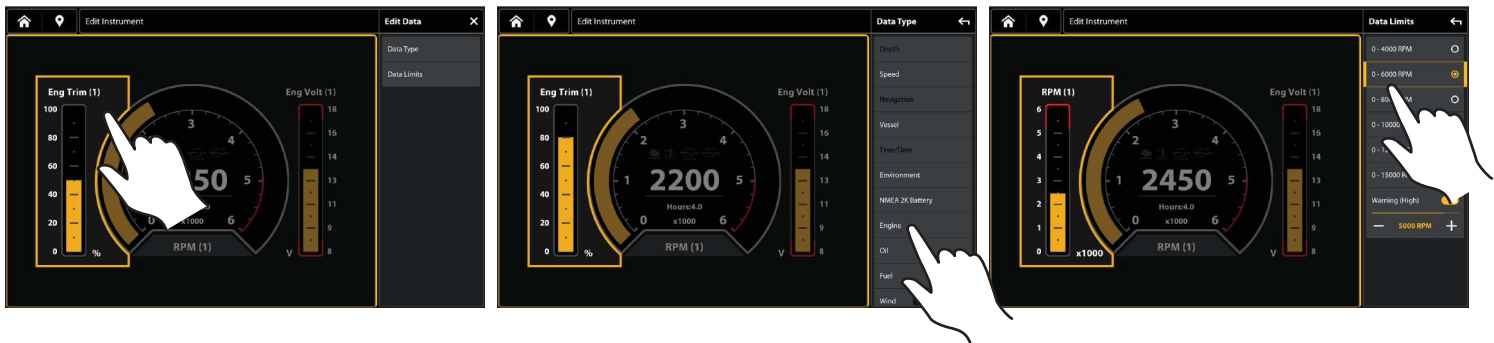

SET UP AN HDMI VIEW

(APEX ONLY)

The APEX fish finder provides HDMI video input and output. This allows for video input, such as a camera, and output for connection to an accessory display. The APEX supports the following input/output resolutions:

HDMI In			HDMI Out		
640x480p	4:3	@60Hz	720x480p	16:9	@60Hz
720x480p	16:9	@60Hz	1280x720p	16:9	@60Hz
1280x720p	16:9	@60Hz	1920x1080p	16:9	@60Hz
1920x1080p	16:9	@60Hz	1280x720p	16:9	@50Hz
720x576p	16:9	@50Hz	1920x1080p	16:9	@50Hz
1280x720p	16:9	@50Hz			
1920x1080p	16:9	@50Hz			

Display a Video View

NOTE

If you have just plugged in your HDMI device to the APEX fish finder, reboot the unit to display the HDMI view.

1. Press the HOME key.
2. Select the View tool.
3. Select Video.
4. Select a Video View

Selecting a Video View

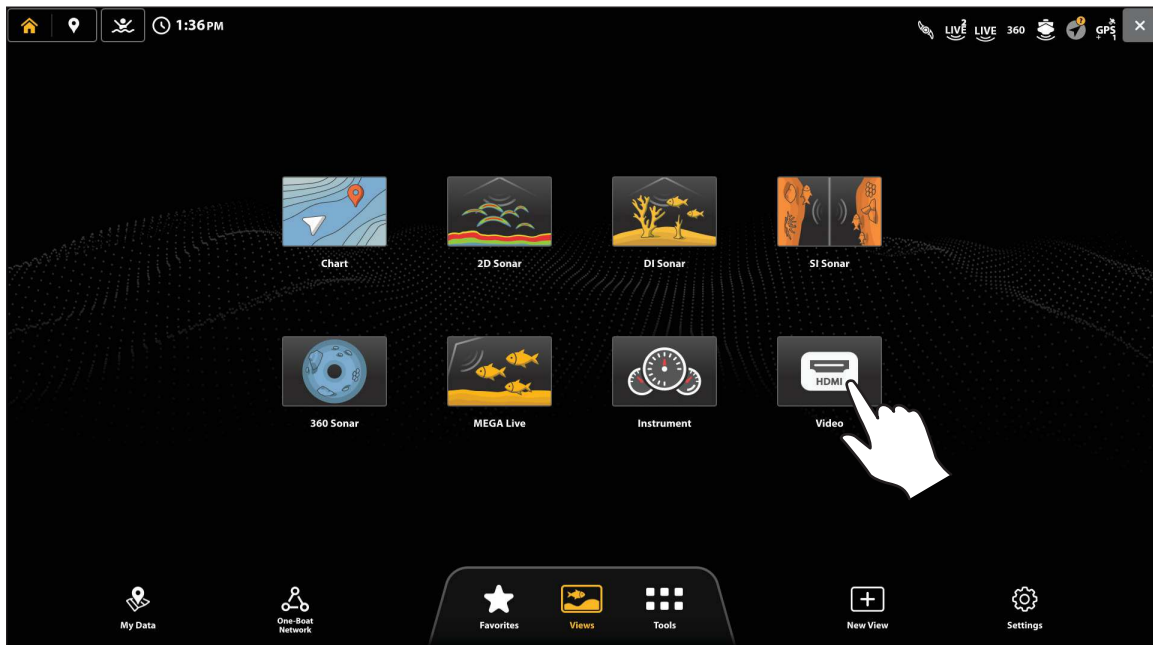

See **Create a New View** to add a Video view to a multi-panel screen.

Customize a Video View

In a Video View, you can customize the brightness and contrast.

1. With a Video View displayed on-screen, tap the Menu icon, or press the MENU key once.
2. **Change the Brightness:** Select Brightness. Press and hold the slider to adjust the setting.
3. **Change the Contrast:** Select Contrast. Press and hold the slider to adjust the setting.
4. **Close:** Press and hold the EXIT key.

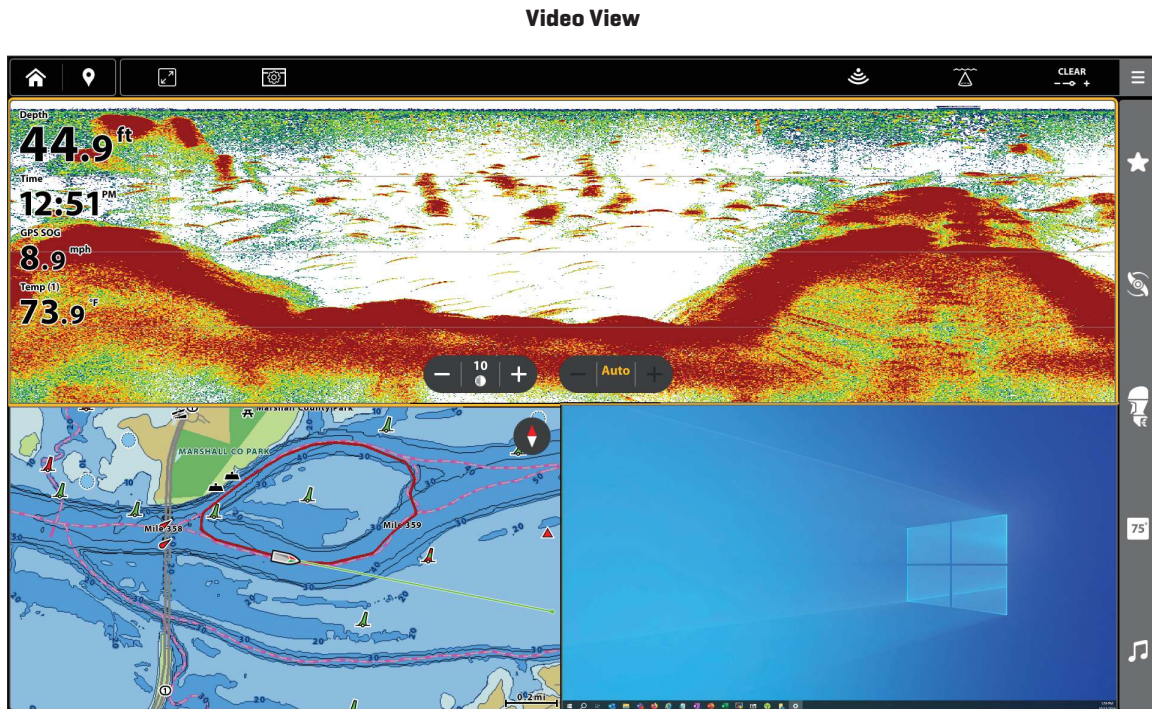
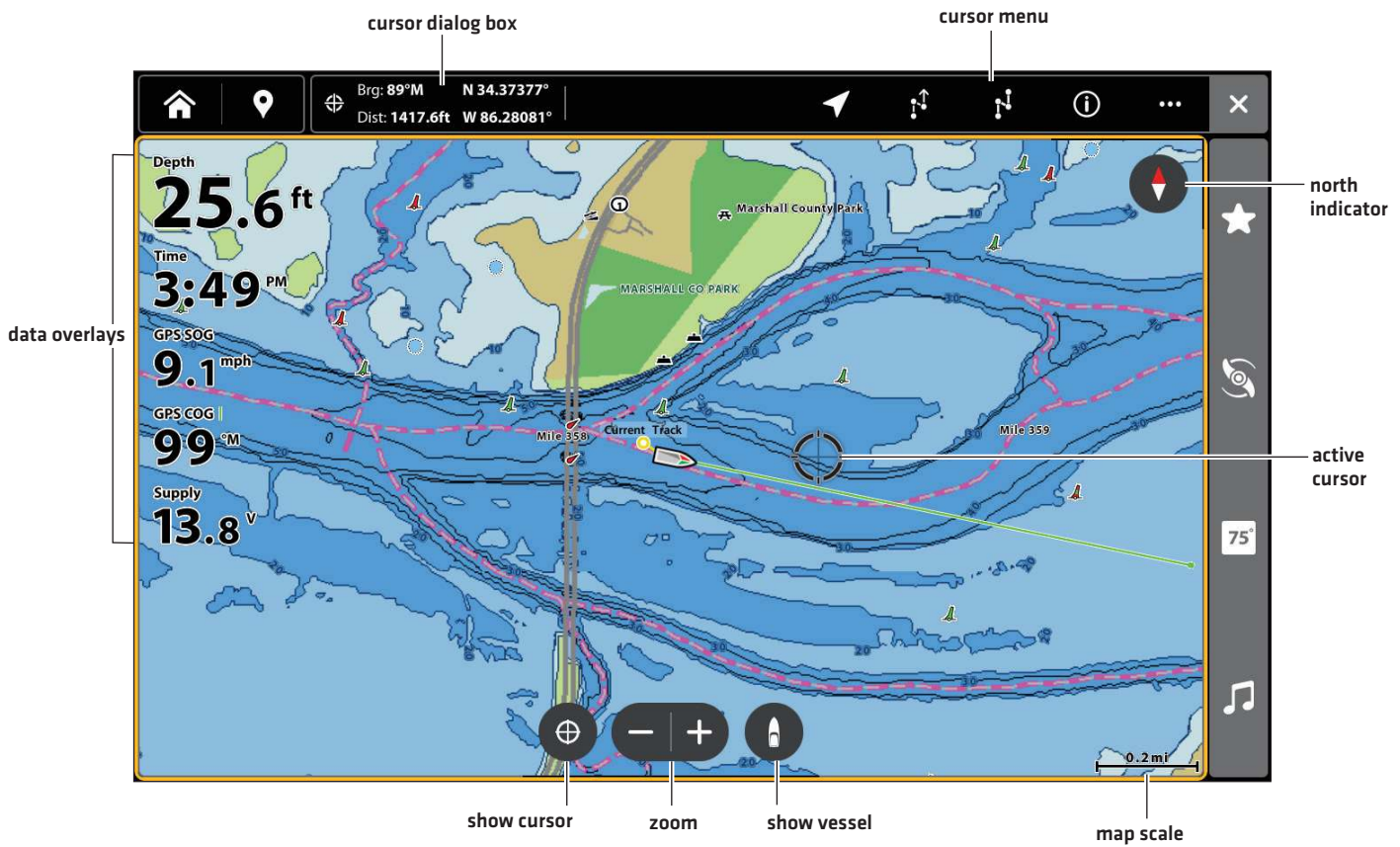

CHART OVERVIEW

To enable the navigation features, the fish finder must have a GPS fix from an internal or external GPS receiver [see *Getting Started* to check the sensor reception]. Some of these features also require a compass/heading sensor to be connected to the fish finder.

2D Chart View (Humminbird Basemap)



Display a Chart View

1. Press the HOME key.
2. Tap the Views tool.
3. Tap Chart to view the Chart group.
4. Tap a Chart view to display.

OR

1. Press the HOME key.
2. Tap the Favorites tool.
3. Tap a Chart view to display.

Map Source Overview

The Humminbird fish finder includes built-in charts by Humminbird, Navionics, and AutoChart Live. You can also install a microSD or SD map card with additional chart information for a particular location [separate purchase required]. Humminbird is the default map source, but you can change the map source at any time [see [Using the Built-in Charts](#)].

Your Humminbird fish finder supports the following charts [some require a separate purchase]:

Humminbird	Basemap [built in]
	CoastMaster, LakeMaster, Lake Master PLUS, SmartStrike, Aerial View, ChartSelect-downloaded maps and layers
	AutoChart, AutoChart PRO, AutoChart Live [built in], SI Mosaic
Navionics	Navionics [built in], Navionics Gold, HotMaps, Navionics Platinum+

Map Source: Humminbird Basemap

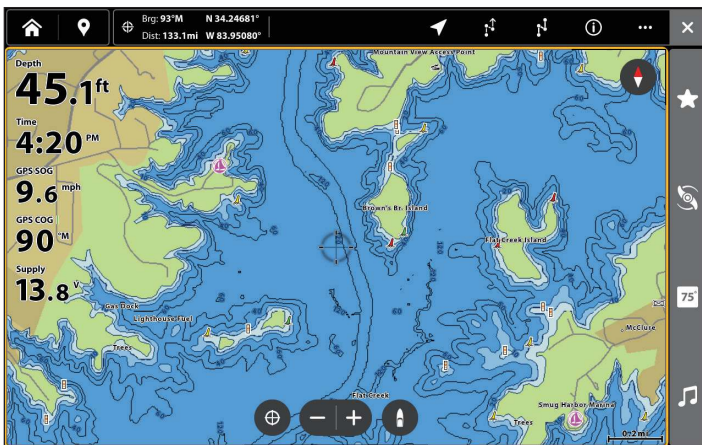

Map Source: Navionics

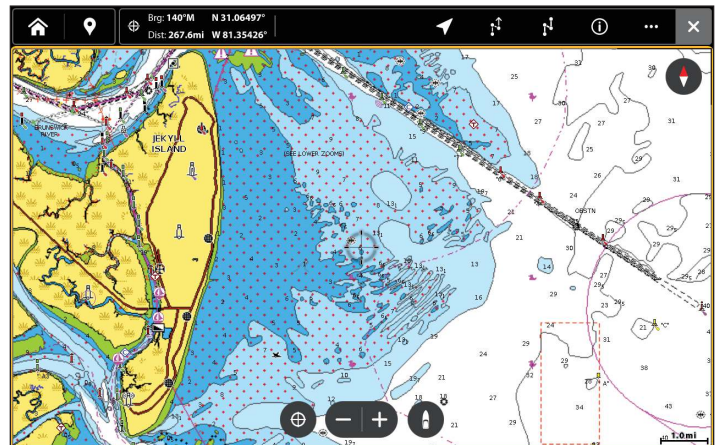

Map Source: SmartStrike Chart Card

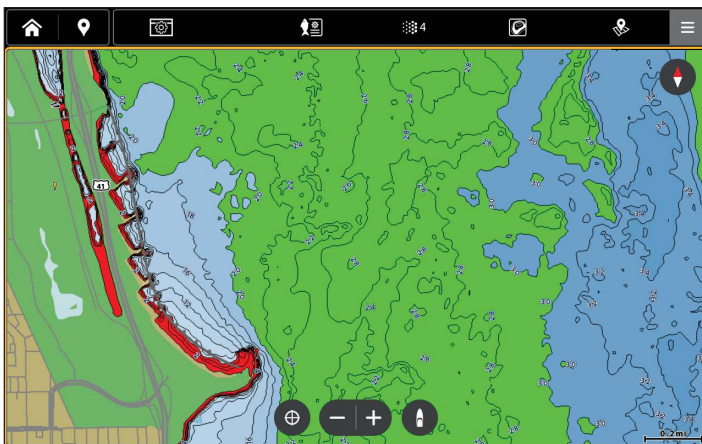

Map Source: AutoChart Live with Bottom Hardness Overlay

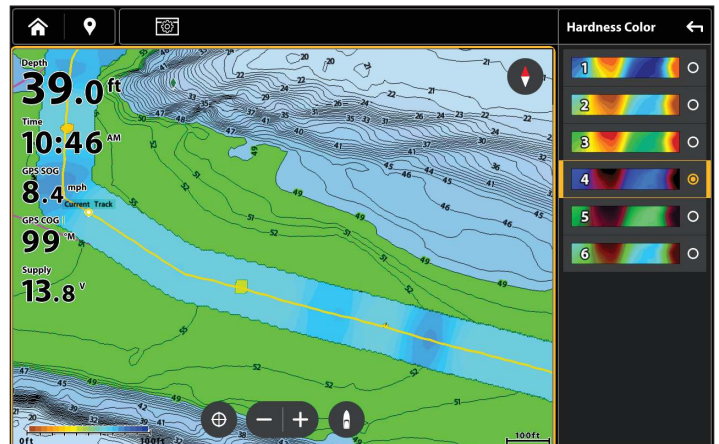

Map Source: LakeMaster VX Chart Card

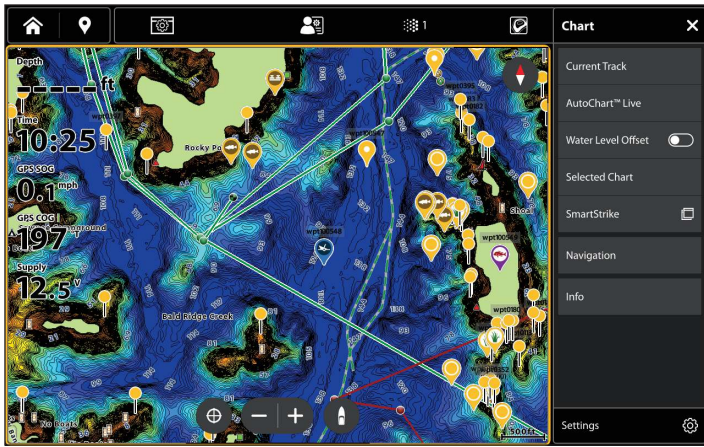

Map Source: CoastMaster VX Chart Card

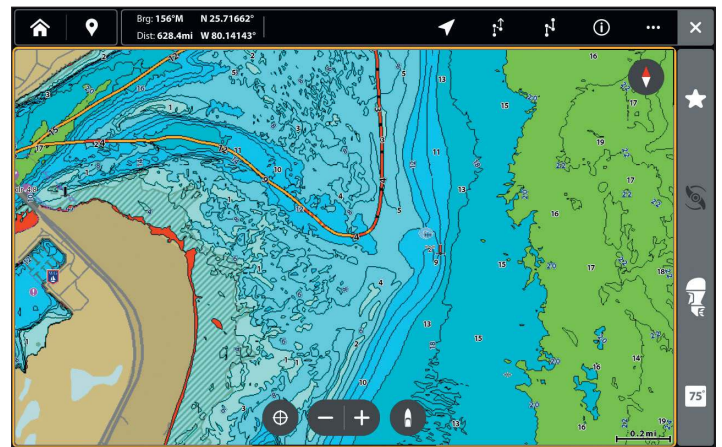

How the Map Source Affects your Chart View Operations

The selected map source influences the menu system. When you change the map source, the menu options for the Chart Views change, allowing you to add navigation data, shading, or alarms.

Install an SD or microSD chart card [separate purchase required] with specific maps or chart layers to add more detail to your Chart views [see *Using Chart Cards*].

NOTE

Visit our Web site at humminbird.johnsonoutdoors.com for the latest compatibility information.

Using Built-in Charts

Your Humminbird fish finder includes built-in charts by Humminbird and Navionics. Display the built-in charts and add data overlays and map layers to customize your Chart view.

Change the Built-in Chart Source

1. With a Chart View displayed on-screen, tap the Menu icon in the Top Bar, or press the MENU key once.
2. Select Settings.
3. Under System Settings, select Chart Source.
4. Select between Humminbird and Navionics.

Humminbird Charts

When Humminbird is selected as the map source, you can use the system defaults, or you can set the menu settings to your preference. You can use the built-in Humminbird Basemap or a Humminbird SD Chart Card [see *Using Chart Cards*].

1. Select Humminbird as the map source.
2. Under Humminbird Charts, select Basemap or Legacy Chart Cards.

Humminbird Basemap	Select the Humminbird Basemap to display contour data and navigation aids, including hazards, buoys, daymarkers, marinas, and other points of interest. The Basemap also shows depth markings and spot soundings (for coastal areas).
Legacy Chart Cards*	Select the Legacy Chart Card to display the map data from the installed legacy chart card. *Required Equipment: Humminbird chart card. See <i>Using Chart Cards</i> for more information.

Change Humminbird Basemap System Settings

1. With a Chart View displayed on-screen, tap the Menu icon in the Top Bar, or press the MENU key once.
2. Select Settings.
3. Under System Settings, select Basemap Settings.
4. Set the following menus to your preference:

Text Size	Adjust the setting to change the size of font used in the Basemap.
Symbol Size	Adjust the setting to change the size of the symbols used in the Basemap.

2D Chart View (Humminbird Basemap)

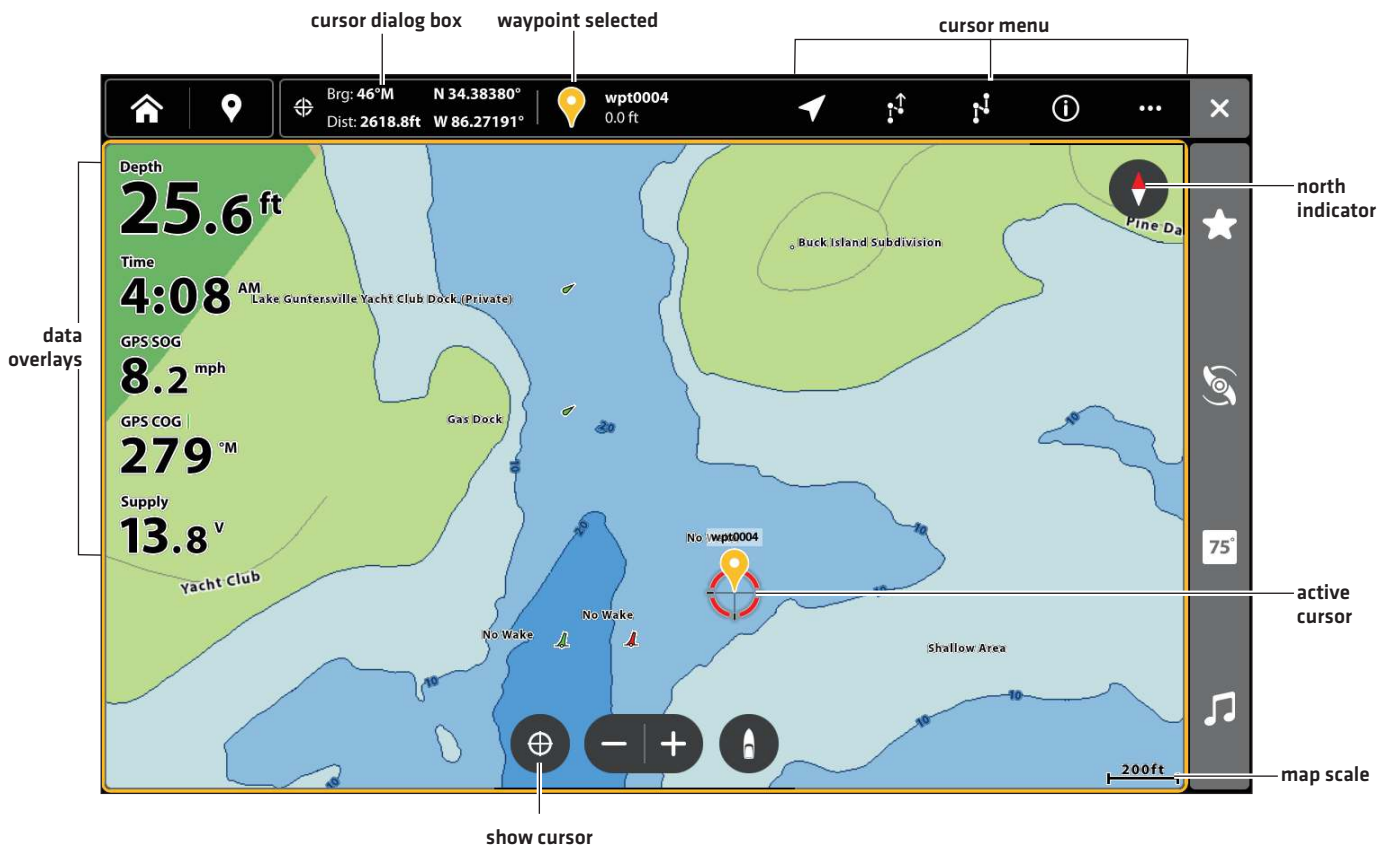

2D Chart View during Navigation

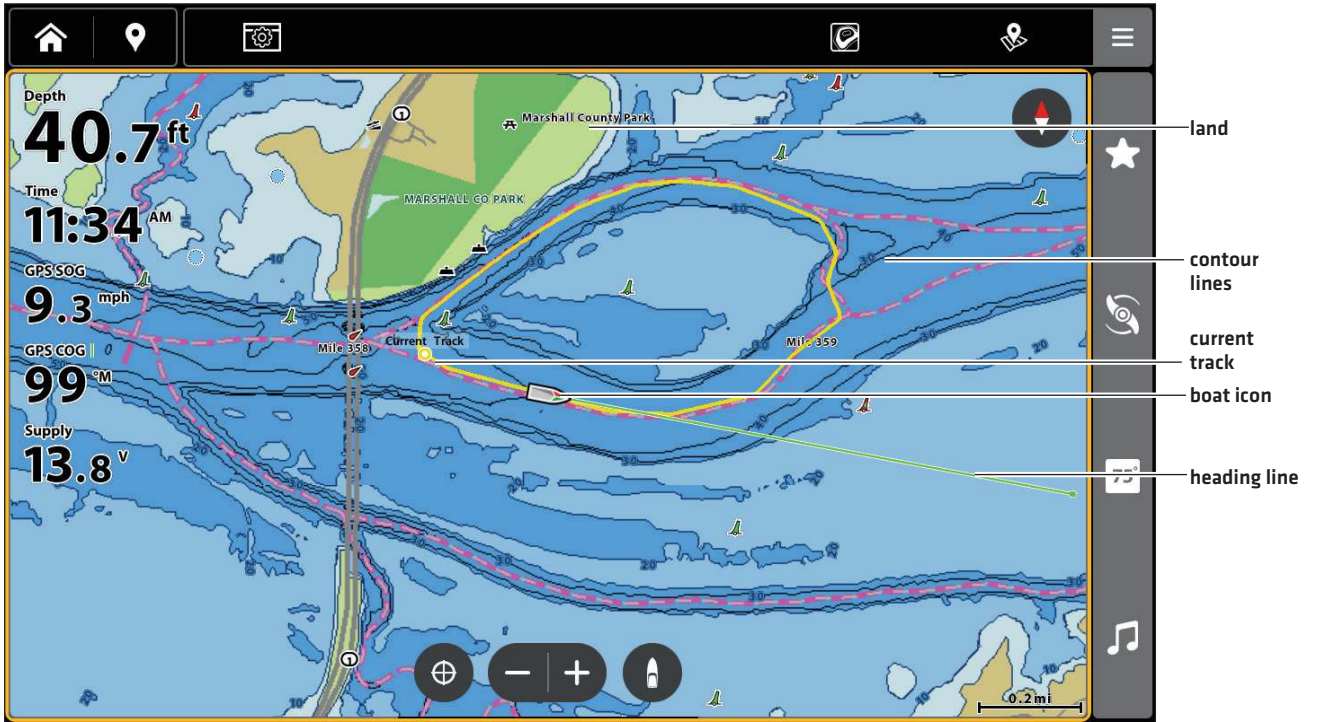

Navionics

When Navionics is selected as the map source, you can use the system defaults, or you can set the menu settings to your preference. You can use the built-in map, or you can install an SD chart card with additional features.

Change Navionics Basemap System Settings

1. With a Chart View displayed on-screen, tap the Menu icon in the Top Bar, or press the MENU key once.
2. Select Settings.
3. Under System Settings, select Basemap Settings.
4. Set the following menus to your preference:

Easy View	Turn on Easy View to simplify the Chart View. The icon size and text size increase for easier viewing.
Dynamic Tides/ Currents	Turn on Dynamic Tides/Currents to display an icon on the Chart View that indicates the status of the tides and currents. The provided data is affected by the station's time zone.
Symbols	Select USA or International symbols to display on the Chart View.
Map Datum	Use Map Datum to change the map coordinate system used by the control head to match those of a paper map. Almost all electronic charts use the WGS84 Map Datum and most likely do not require a setting change. [Default = WGS84]
Chart Offset	Use Chart Offset to move the chart position on-screen and correct a position error in the cartography. Turn on Chart Offset, and use the sliders to adjust the latitude/longitude coordinates. The Chart Offset setting applies to all charts, not just the chart that requires correction.
Chart Boundaries	Turn on Chart Boundaries to display chart boundaries on the Chart View. The dotted lines of a chart boundary indicate an area that contains a different map. Use the Joystick to move the cursor within a chart boundary, and press the +ZOOM key to see a closer view of the chart.

NOTE

There are also alarm and display options that are exclusively available for Navionics charts. See *Navigation Alarms Overview* and *Customize the Chart View* for more information.

2D Chart View [Navionics]



dynamic tides/currents icon

symbols

chart boundary

AutoChart Live

AutoChart LIVE can be used when Humminbird CoastMaster, Humminbird LakeMaster or Navionics is set as the map source. AutoChart LIVE uses data from an installed GPS receiver and 2D transducer (down beam, digital CHIRP or single-frequency DualBeam PLUS or Dual Spectrum sonar) to create detailed depth maps of your favorite waters.

See the *AutoChart Live Overview* section in this manual for complete details about this feature.

2D Chart View (Humminbird LakeMaster with AutoChart Live Overlay)

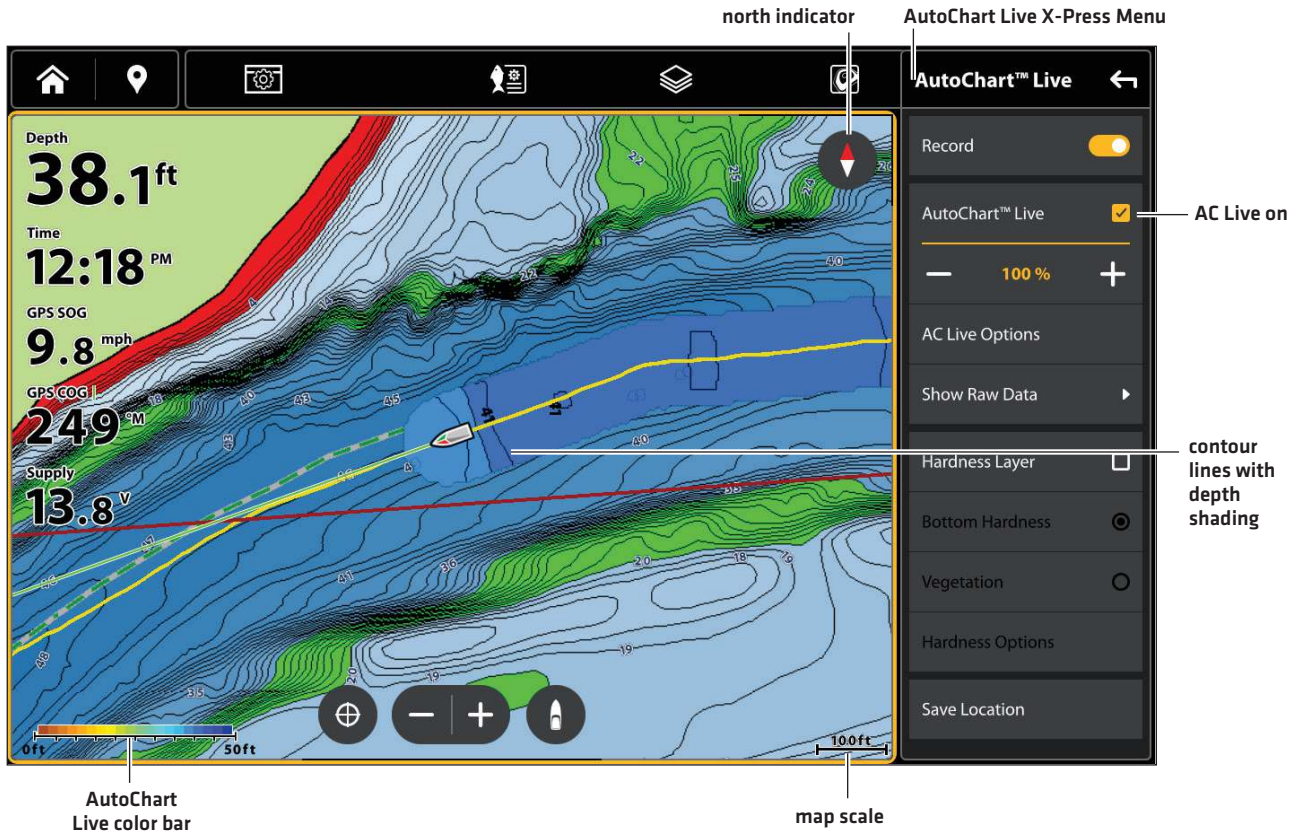

Using Chart Cards

When you install an SD or microSD chart card (separate purchase required), the fish finder automatically chooses the best map to display. If you install more than one SD or microSD card, you can choose which map source you want to use.

Your fish finder may be compatible with an SD or microSD card (depending on your fish finder model). Locate the instructions to install your SD card below and proceed to **Change the Map Source**.

Insert an SD Card

If your fish finder is compatible with SD cards, use the following instructions to install and eject it from the fish finder. If your fish finder is compatible with microSD cards, proceed to the next section below.

1. Insert the card into the slot with the label facing left.
2. The control head automatically chooses the best chart to display. If more than one type of SD card is installed, follow the on-screen prompts to select the map source.
3. **Remove:** Press the SD card into the slot and then release it. Pull the card from the slot.

Insert a microSD Card

1. Remove the microSD card slot cover.
2. Position the microSD card so that the label faces up.
3. Insert the card into the slot until it clicks into place.
4. Replace the slot cover so it is secure.
5. **Remove:** Press the card into the slot and then release it. Pull the card from the slot.

CAUTION

Do not leave the card slot cover open. The slot cover should always be closed to prevent water damage to the unit.

Change the Map Source

When you install an SD card, the map source is changed automatically to match the SD card map source. You can also change the map source using the Settings tool.

When you change the map source, the menu options for the Chart Views also change, allowing you to add navigation data, shading, alarms, and more. See each section for details.

1. With a Chart View displayed on-screen, tap the Menu icon in the Top Bar, or press the MENU key once.
2. Select Settings.
3. Under System Settings, select Chart Source.
4. Select the Chart Source to display.

View Chart Card Info

Use the following steps to review the information about the installed Humminbird chart card.

1. With a Chart View displayed on-screen, tap the Menu icon in the Top Bar, or press the MENU key once.
2. Select Settings.
3. Under System Settings, select Chart Source.
4. Select Humminbird: Chart Card Info.

Select between Multiple VX Chart Cards

If you have more than one VX chart card in your fish finder or shared across the network, select which card you want to use.

NOTE

XPLORE fish finders come with LakeMaster VX and CoastMaster VX maps on one card. Use these instructions to switch between LakeMaster and CoastMaster.

1. With a Chart View displayed on-screen, tap the Menu icon in the Top Bar, or press the MENU key once.
2. Select Selected Chart.
3. Select the VX card you want to display.

Selecting a VX Chart

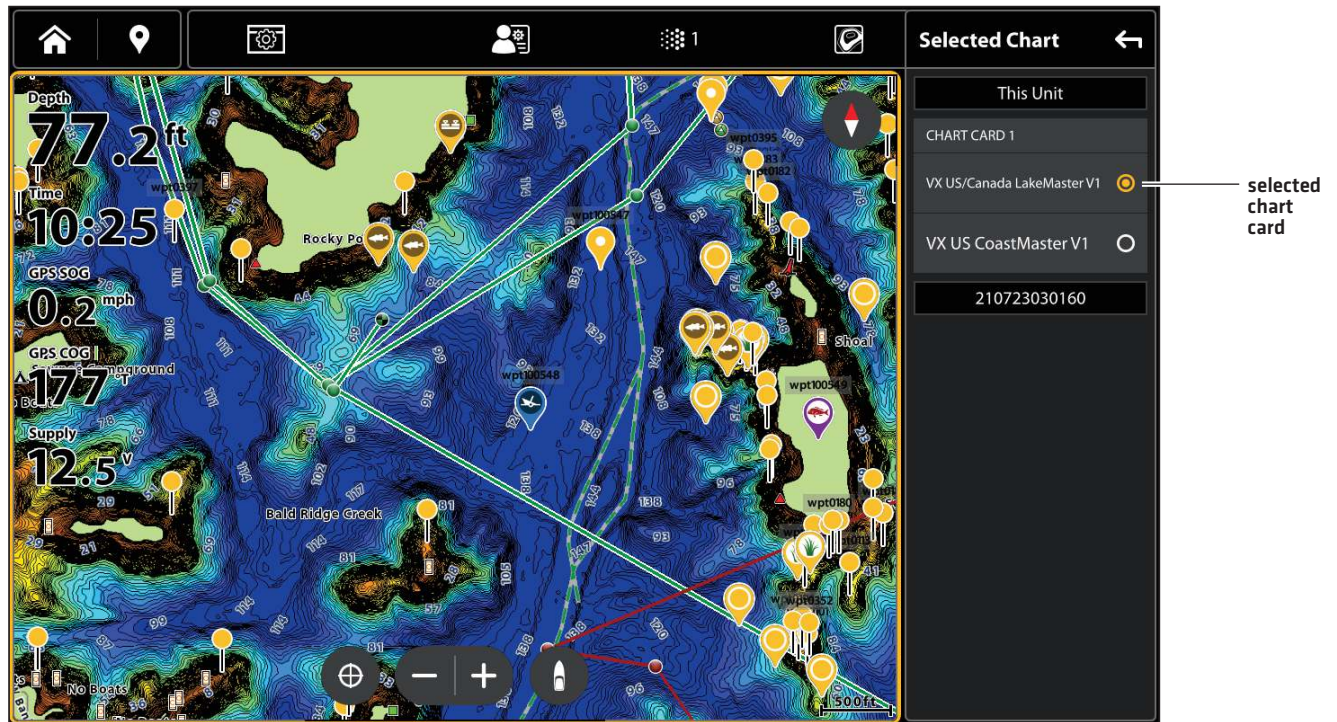

Chart Settings

Humminbird Chart Cards with VX Technology have additional Chart Settings available.

1. With a Chart View displayed on-screen, tap the Menu icon in the Top Bar, or press the MENU key once.
2. Select Settings.
3. Under System Settings, select VX Settings.
4. Set the following menus to your preference:

Dynamic Tides/ Currents	Turn on Tides and Currents to review information for the nearest tide and current stations to your present position. *CoastMaster chart card required
Text Size	Adjust the setting to change the size of font used in the Basemap.
Symbols	Adjust for International or U.S. symbols. * Humminbird Chart Card with VX technology required
Symbol Size	Adjust the setting to change the size of the symbols used in the Basemap.
Safe Depth	Select this menu to set the minimum depth level for your vessel and to turn on highlights for hazards shallower than that level. * Humminbird Chart Card with VX technology required

CUSTOMIZE THE CHART VIEW

The settings in this section are optional. You can use the default settings for the chart appearance and map source, or you can customize the Chart View for your navigation preferences. See **Views** for more information.

Set the Water Level Offset

Use the following instructions to adjust the water level setting read by the fish finder. For example, if the lake is down 5 feet, set the Water Level Offset setting to -5. The displayed numbers on the Contour Lines will adjust from the Water Level Offset setting, and the water level offset will be highlighted in brown to extend the land visually on the display.

1. With a Chart View displayed on-screen, tap the Menu icon in the Top Bar, or press the MENU key once.
2. Select Water Level Offset, and tap, or press the ENTER key, to turn the setting on.
3. Tap the +/- icons, or press the +/- Zoom keys, to adjust the setting.

Display Chart Layers

Display Layers on the Chart view to add more details and data.

1. With a Chart View displayed on-screen, tap the Layers  icon in the Top Bar.
2. Set the following menus to your preference:

Humminbird Premium Card

Humminbird Layers Options	
Shaded Relief	Select to use shadows to show features of the lake bed.
Bottom Hardness	Select to show bottom hardness. * On select premium chart cards.
Aerial Imagery	Turn on to display the aerial imagery and adjust the transparency.
Aerial Display Area	Select between Land and Water, Land only, or Water only.

Navionics

Display Layers on the Chart view to add more details and data. With those locations, you just have Satellite Maps [ON], 100%, and Land highlighted. The zoom level has to be less than 2 miles.

Navionics Layers Options	
Layers	Select to turn Layers on.
Satellite Maps	Press and hold the slider, or press the +/- Zoom keys, to adjust the setting.
Display Area	Land: Select to display the satellite layer over land only. Land + Shoals: Select to display the satellite layer over land and shallow water. Land + Sea: Select to display the full satellite layer.

Displaying Humminbird Overlays

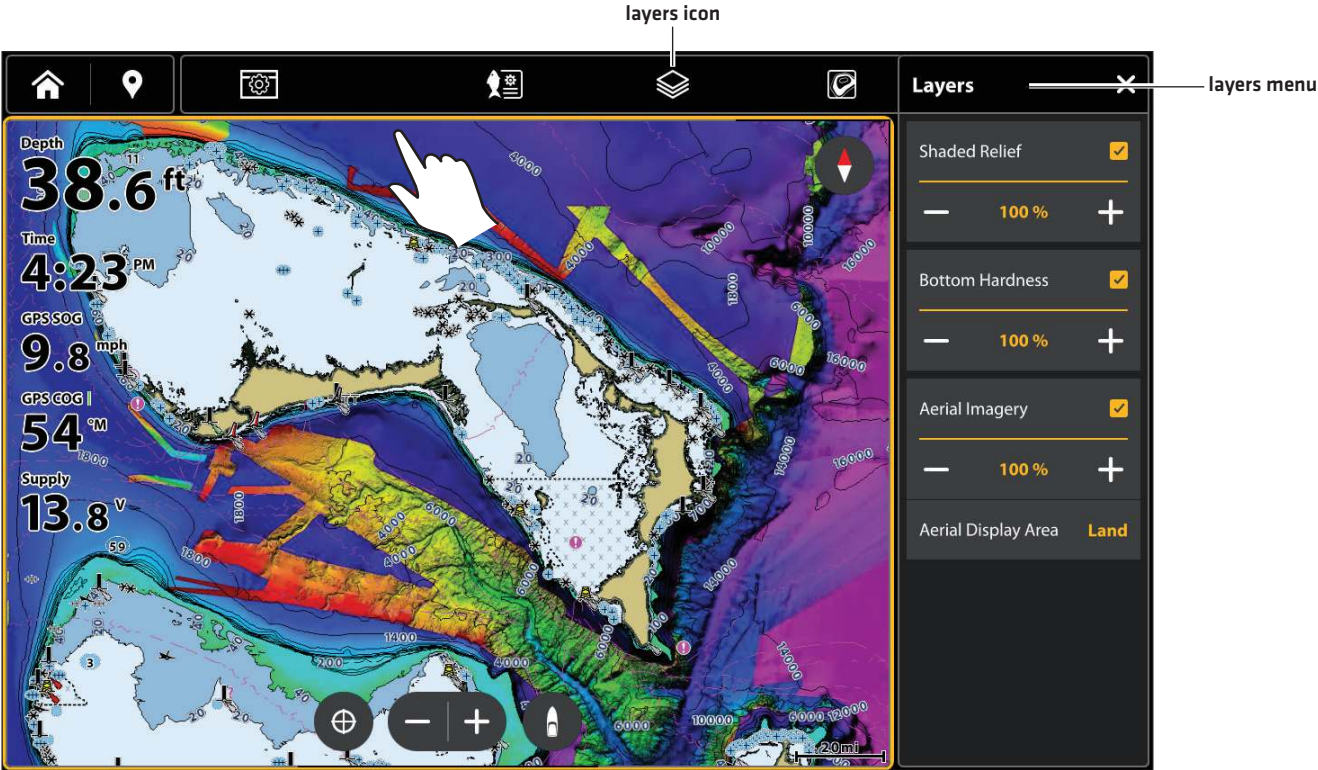

Customize the Humminbird Chart Display (optional)

Humminbird must be selected as the map source to enable the following features. The menu options will be different for Humminbird Chart Cards with VX Technology and Humminbird Legacy Chart Cards.

Humminbird Chart Cards with VX Technology

When Humminbird is selected as the map source, additional menus to customize the Humminbird chart display are added to the menu system.

Select a Chart Preset

Use Chart Presets to quickly alternate between settings. You can use the default Fishing or Navigation settings provided, or you can create a custom User preset with your preferences. The Fishing and Navigation presets are also fully customizable. You can restore each preset to its default settings at any time.

1. With a Chart view displayed on-screen, tap the Chart Preset icon in the Top Bar.

OR

From the Chart X-Press Menu, select Settings > Chart Preset.

2. Select a preset.

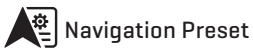

Selecting a Chart Preset

Chart Preset icon

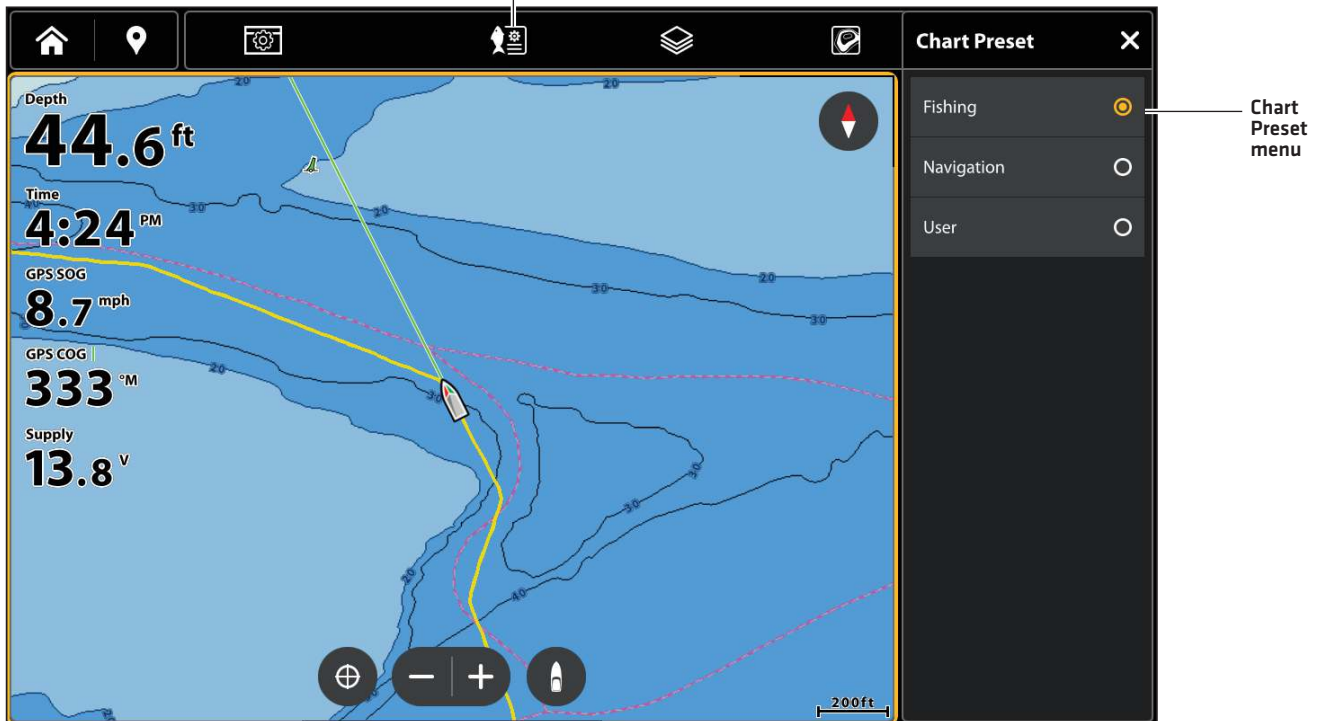

Display Contour Lines and Depth Colors

You can display or hide contour lines, highlight shallow water, and highlight a depth range on the map.

1. With a Chart View displayed on-screen, tap the Menu icon in the Top Bar, or press the MENU key once.
2. Select Settings.
3. Select Depth/Contours.
4. Select the following menus to your preference.

Contour Lines	Turn on Contour Lines to display contour lines on the map.
Contour Density	Use Contour Density to adjust the density of the contour lines displayed on the map. You can set the density to High, Medium, or Low. Contour lines must be turned on to adjust this feature. Contour density can only be customized in the Fishing and User presets. Navigation contour density cannot be changed.
Contour Color	Use Contour Color to adjust the color of the contour lines displayed on the map. Contour lines must be turned on to adjust this feature.
Depth Palette	Turn on Depth Palette to turn on depth area colors in the Chart View.
Palette Min/Max Range	You can adjust the range of data shown on the chart by changing the minimum range and maximum range on the display. The range you select affects how the depth colors are displayed. For best results, set a narrow depth range threshold. For example, set the Palette Min Range to 100 and the Palette Max Range to 200.
Color Palette	Use Color Palette to change the colors used to display the map.

QUICK TIP! You can also change the Color Palette using the Color Palette icon  1 on the Top Bar.

Set Depth Highlights

Highlight deep and shallow waters in Chart View and Chart Combo Views using the following CoastMaster features. Highlight colors are customizable.

- Depth Highlights allow you to select up to four depth ranges to be highlighted on the chart.
- Shallow Water Highlight identifies shallow waters when the depth is equal to or less than the level you set.

1. With a Chart View displayed on-screen, tap the Menu icon in the Top Bar, or press the MENU key once.
2. Select Settings.
3. Select Depths Highlight.
4. Select the following menus to your preference.

OR

1. With a Chart View displayed on-screen, tap the Depth Highlight  icon in the Top Bar.
2. Select the following menus to your preference.

Depth Highlight	Turn on Depth Highlight to highlight a depth setting in the Chart Views. The depth you set will be highlighted in the color selected. You can set up to four depth highlights.
Highlight Range	When a Depth Highlight is active in the Chart Views, use Highlight Range to highlight a range on each side of the highlighted depth. For example, if you know a certain fish is holding at 18 to 20 feet, you can set the Depth Highlight at 19 feet, and the Highlight Range a +/- 1 foot. The view will show a green band from 18 to 20 feet.
Shallow Water Highlight	Turn on Shallow Water Highlight and adjust the slider. When the depth is equal to or less than the amount set, it will be highlighted in red [or the color you select] in the Chart Views. For example, if your boat has a draft of 3 feet, set the Shallow Water menu to 3 feet, and the unit will draw a red band from 0 to 3 feet.

Adjusting the VX Chart Card Depth Display Settings

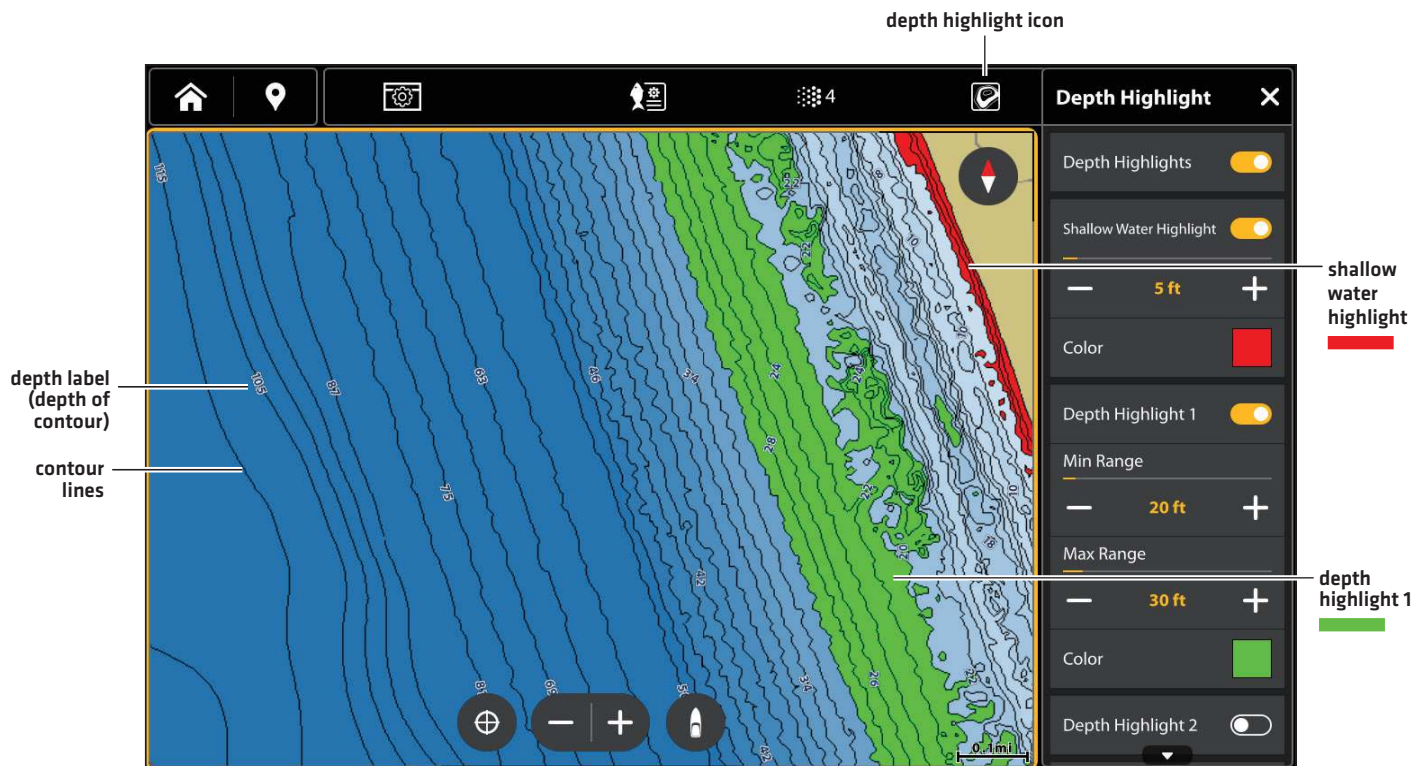

The screenshot shows the VX Chart Card Depth Display Settings interface. The interface is divided into two main sections: a chart view on the left and a settings panel on the right. The chart view displays depth contours with labels (e.g., 100, 80, 60, 40, 20) and a red band representing shallow water highlight. The settings panel includes a 'Depth Highlight' menu with a 'depth highlight icon' label, a 'Shallow Water Highlight' menu with a 'shallow water highlight' label, and two 'Depth Highlight' entries. The first entry is set to 20 ft with a green color and a 'depth highlight 1' label. The second entry is set to 30 ft with a red color. The chart also shows 'depth label (depth of contour)' and 'contour lines' labels.

Set Chart Orientation

Select your display preference: North-Up, Head-Up, Course-Up, etc.

1. With a Chart View displayed on-screen, tap the Menu icon in the Top Bar, or press the MENU key once.
2. Select Settings.
3. Select General.
4. Select Orientation.
5. Select an orientation to apply to the chart.

QUICK TIP! You can also select the Chart Orientation button on the View screen. See the illustration below.

Head Up [compass or GPS required]	The vessel's current heading points up, and the chart rotates around the vessel icon so that it always points up on the view. The heading is provided by the connected compass/heading sensor. If a compass is not connected, the vessel will be oriented according to the COG [Course Over Ground].
North Up	The chart is oriented with North up on the display, and the vessel rotates according to its heading or COG [Course Over Ground].
COG Up	The chart is displayed with the vessel oriented in a fixed position pointing up, and the chart rotates according to the vessel COG [Course over Ground].
Course Up	During navigation, the intended course or route leg is shown at the top of the view. Objects ahead of the vessel are drawn above the vessel. When the vessel is not navigating, the current heading is displayed.

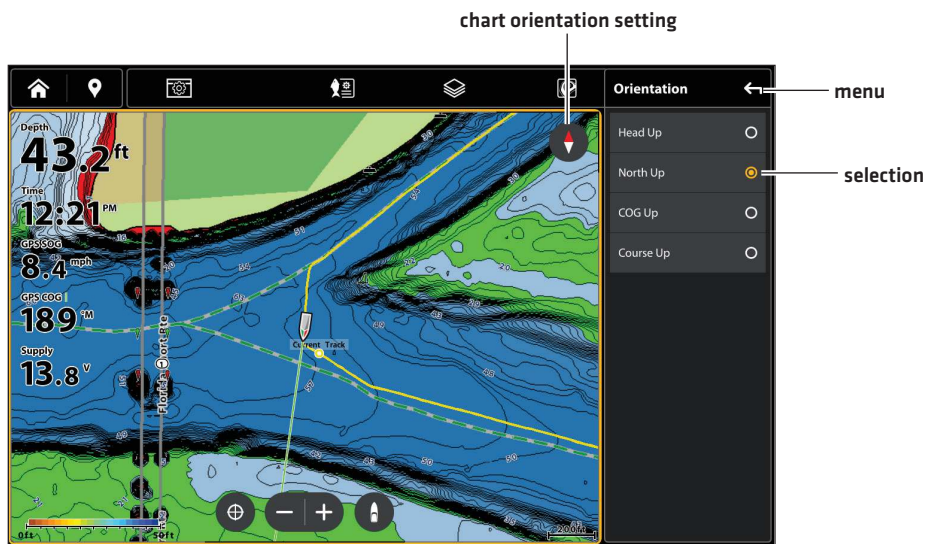

Turn on/off Vessel Offset

Vessel Offset allows you to see more of the view based on the speed of the vessel. Vessel Offset works with Auto Shift Speed.

1. With a Chart View displayed on-screen, tap the Menu icon in the Top Bar, or press the MENU key once.
2. Select Settings.
3. Select General.
4. Select Vessel Offset.

Off	The vessel is displayed in the center of the Chart View.
On	The vessel is displayed on the lower part of the Chart View.
Auto	When the vessel is moving below the Auto Shift Speed setting, the vessel icon will be displayed in the center of the view. When the vessel is moving at or above the Auto Shift Speed setting, the vessel icon will move to the edge of the view so that more of the view is shown on-screen. To change the Auto Shift Speed Setting, press the HOME key. Select Settings > My Boat > Auto Shift Speed.

Show/Hide Spot Soundings (Humminbird Basemap)

Spot Soundings are depth measurements shown on the chart. The available settings are determined by the installed map card and selected map source. Humminbird Basemap must be selected as the map source.

1. From the Humminbird Settings menu, select Spot Soundings.
2. Select On or Off.

Turn on Auto Zoom

Auto Zoom focuses the view on the current route leg as it is being navigated. As the vessel's speed increases, the chart range will increase. If you press the ZOOM keys to see more or less of the view, Auto Zoom will pause.

NOTE

The Auto Zoom setting does not apply to the 3D Views.

1. Press the HOME key.
2. Select Settings.
3. Select My Boat.
4. Select Navigation Settings.
5. Under Navigation Options, select Auto-Zoom. Tap the on/off button, or press the ENTER key, to turn it on.

Humminbird Legacy Chart Cards

When Humminbird is selected as the map source, additional menus to customize the Humminbird chart display are added to the menu system.

1. With a Chart View displayed on-screen, tap the Menu icon in the Top Bar, or press the MENU key once.
2. Select Settings.
3. Select Humminbird Settings.
4. Select the following menus to your preference.

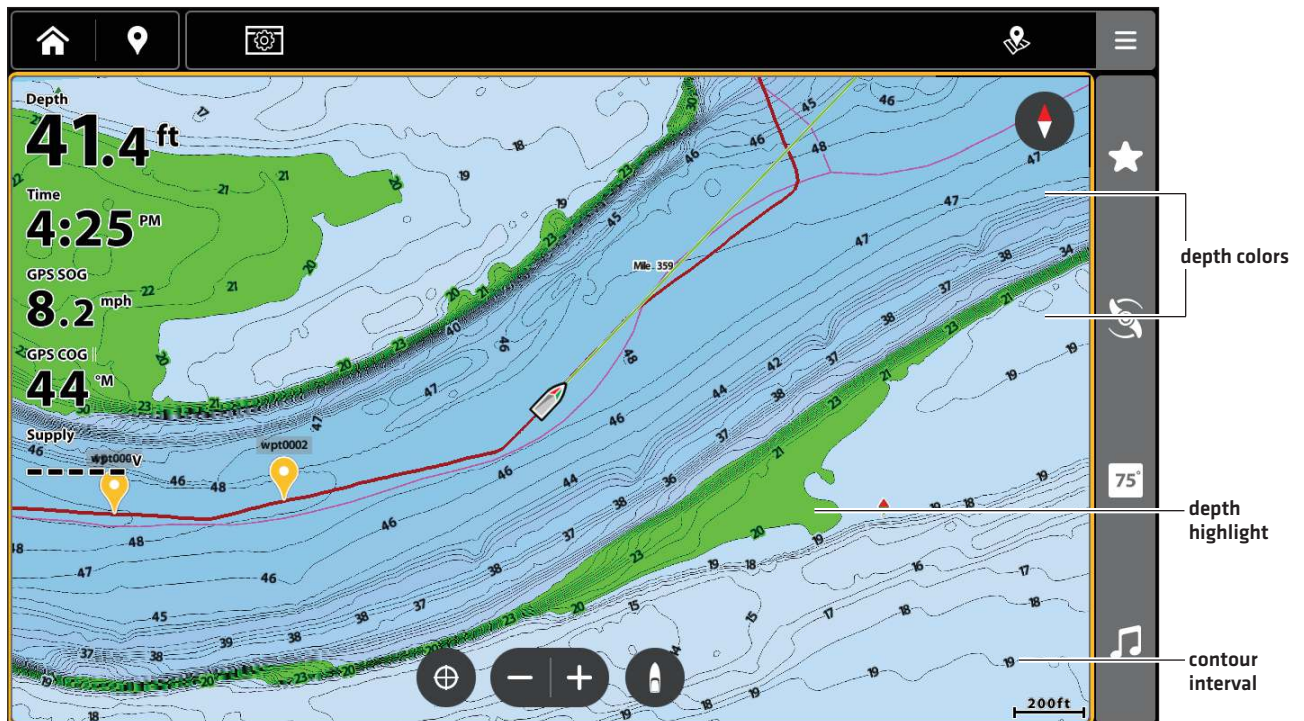

Depth Colors	Turn on Depth Colors and adjust the range for depth shading in the Chart Views.
Depth Highlight	Turn on Depth Highlight to highlight a depth setting in the Chart Views. The depth you set will be highlighted in green. Use Depth Highlight with Highlight Range.
Highlight Range	When a Depth Highlight is active in the Chart Views, use Highlight Range to highlight a range on each side of the highlighted depth. For example, if you know a certain fish is holding at 18 to 20 feet, you can set the Depth Highlight at 19 feet, and the Highlight Range at +/- 1 foot. The view will show a green band from 18 to 20 feet.
Shallow Water	Turn on Shallow Water and adjust the slider. When the depth is equal to or less than the amount set, it will be highlighted in red in the Chart Views. For example, if your boat has a draft of 3 feet, set the Shallow Water menu to 3 feet, and the unit will draw a red band from 0 to 3 feet.
Contour Interval	Turn on Contour Interval to display lines at set intervals on the Chart View. Adjust the slider to set the distance between each line. Contour Interval is also affected by the Water Level Offset setting. See <i>Map Source: Using Built-in Charts</i> .
Orientation	Set the orientation to Head Up, North Up, COG Up or Course Up.
Vessel Offset	Turn Vessel Offset On, Off or on Auto.
Overlays	Turn on available overlays.

Customize the Navionics Chart Display (optional)

Navionics must be selected as the map source to enable the following features.

Select Map Data

When a Navionics chart is selected as the map source, you can set nav aids, marine, and land icons to hidden or visible. The Depth menu option allows you to see shading on the map based on the set depth.

1. With a Chart View displayed on-screen, tap the Menu icon in the Top Bar, or press the MENU key once.
2. Select Settings.
3. Under Navionics Settings, use the touch screen or the Cursor pad/Joystick to select a menu and change the settings.

Chart View with Nav aids and Icons Displayed (Navionics)

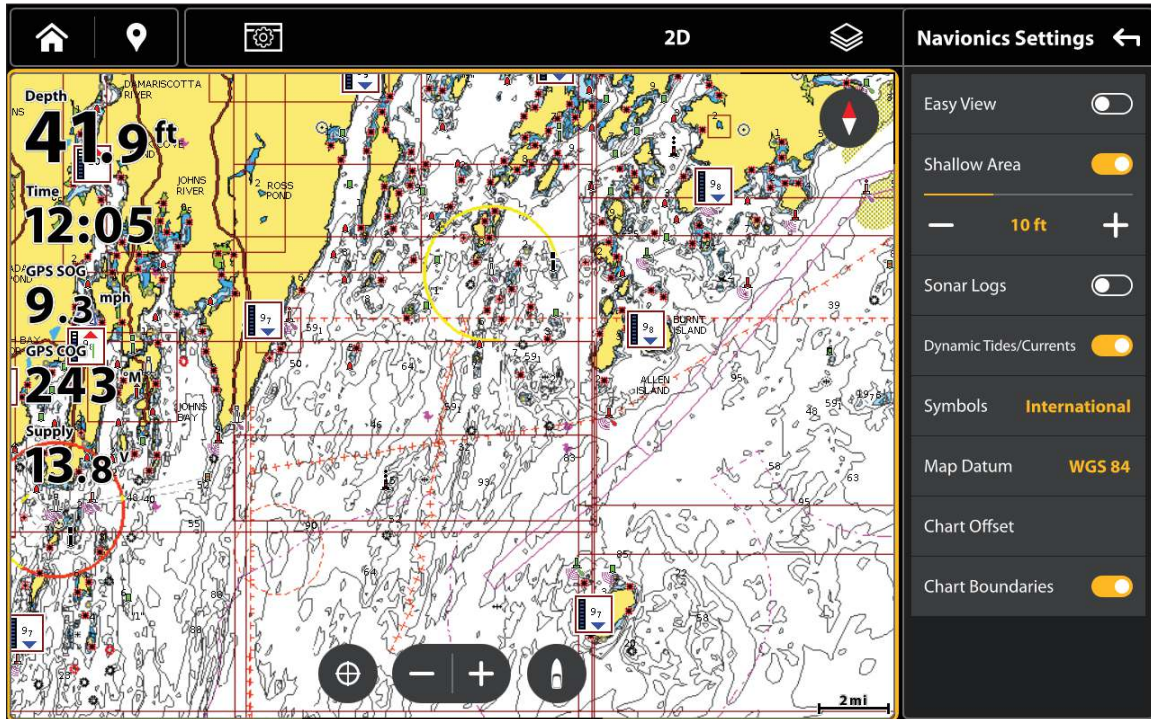

Change the Chart Mode

Use the instructions in this section to switch the Chart View from 2D to 3D.

Change the Chart Mode

1. With a Chart View displayed on-screen, tap the 2D or 3D button in the Top Bar.
2. Select a chart mode.

CHANGE THE CHART VIEW DATA OVERLAYS

Use the Overlays menu to display or hide information on the view. In a Chart View, you can display or hide the vessel icon, navigation data [waypoints, routes, tracks], data overlays, AIS and MARPA targets, and range rings. The available menu options are determined by the accessories attached to the control head network. Also, see **Views** for more information about Overlays.

1. With a Chart View displayed on-screen, tap the Menu icon in the Top Bar, or press the MENU key once.
2. Select Settings.
3. Select Vessel Overlays.
4. Use the touch screen or Cursor pad/Joystick to select a menu and change a setting. [check mark = visible, blank = hidden].

Display Chart Objects

1. With a Chart View displayed on-screen, tap the Menu icon in the Top Bar, or press the MENU key once.
2. Select Settings.
3. Select Chart Objects.
4. Select the type of object.
5. Use the touch screen or Cursor pad/Joystick to select a menu and change a setting. [check mark = visible, blank = hidden].

Chart View with Overlays Displayed (Humminbird CoastMaster VX)

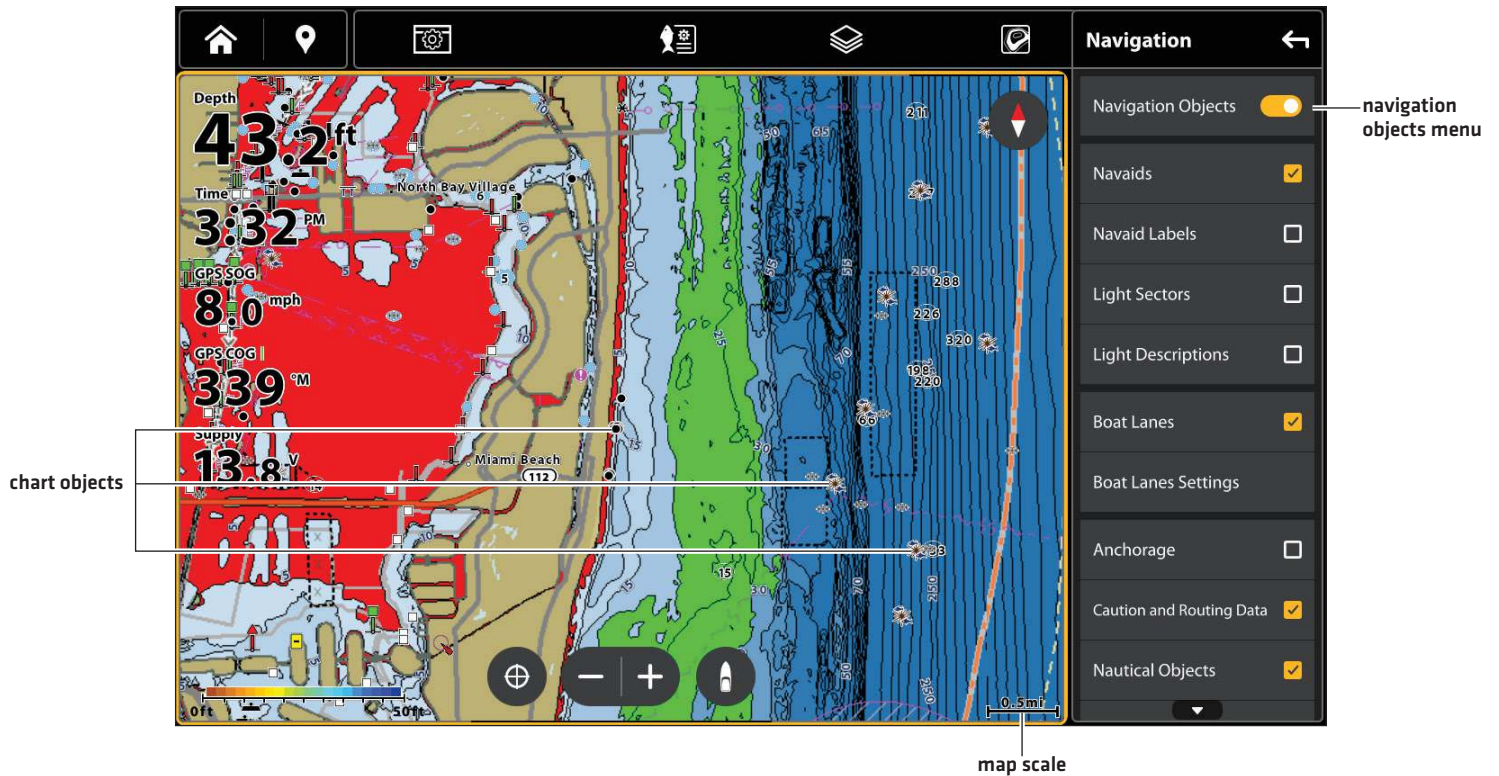

NAVIGATION ALARMS

When an alarm is turned on, an alert will sound or display on the fish finder to indicate the threshold has been exceeded. The settings in this section describe how to turn on a Navigation alarm, adjust the threshold, and display the limits on the view if they are available. The alarm options are determined by the map source.

Chart View with Alarm Overlays Displayed (Humminbird LakeMaster)



Off Course (XTE) Alarm

Turn on Off Course [XTE] to receive an alert if the vessel has traveled outside the selected route. You can also set how far the vessel is allowed to move off course before the alarm is triggered. If the alarm is turned off, the Off Course limit can be displayed on the Chart View, but you won't receive an alert if the vessel crosses it.

Turn on the Alarm

1. Press the HOME key.
2. Select Tools.
3. Select Alarms.
4. Select Alarms > Navigation.
5. Select Off Course [XTE]. Tap the on/off button, or press the ENTER key, to turn it on.

Adjust the Parameters (optional)

1. Press the HOME key.
2. Select Settings.
3. Select My Boat > Navigation Settings > Off Course [XTE].
4. Press and hold the slider, press and hold the ENTER key, or tap the +/- buttons, to set the amount the vessel can move off course.

Display the Off Course (XTE) Limit (optional)

1. With a Chart View displayed on-screen, tap the Menu icon in the Top Bar, or press the MENU key once.
2. Select Settings > General.
3. Select XTE Limits.
4. Tap the check box, or press the ENTER key, to add a check mark and make it visible on the view.

Arrival Alarm

Turn on Arrival to receive an alert when the vessel has reached the destination waypoint, route point, or track point. You can also set the Arrival Radius to indicate how close to the destination point the alarm is triggered. If this alarm is turned off, the Arrival Radius will be displayed on the Chart View, but you won't receive an alert if the vessel crosses it.

The Arrival Radius also influences navigation. If the Arrival Radius is set to 60 feet from the destination point, the arrival is accomplished at 60 feet from the destination point. If there is another point in the route, navigation will then start to the next point.

Turn on the Alarm

1. Press the HOME key.
2. Select Tools.
3. Select Alarms.
4. Select Alarms > Navigation.
5. Select Arrival. Tap the on/off button, or press the ENTER key, to turn it on.

Adjust the Parameters (optional)

1. Press the HOME key.
2. Select Settings.
3. Select My Boat > Navigation Settings > Arrival Radius.
4. Press and hold the slider, press and hold the ENTER key, or tap the +/- buttons, to adjust the radius.

Waypoint Avoidance Alarm

Turn on Waypoint Avoidance to receive an alert if the vessel has crossed the Waypoint Avoidance Radius. If the alarm is turned off, the Waypoint Avoidance Radius can be set for a waypoint, and it will be displayed on the Chart View, but you won't receive an alert if the radius is crossed.

Turn on the Alarm

1. Press the HOME key.
2. Select Tools.
3. Select Alarms.
4. Select Alarms > Navigation.
5. Select Waypoint Avoidance. Tap the on/off button, or press the ENTER key, to turn it on.

Create an Avoidance Waypoint

1. See *Waypoints: Set the Waypoint Radius and Avoidance* to identify a waypoint for avoidance.

Anti-Collision Alarm

If Navionics is selected, and the Anti-Collision alarm is turned on, an alert will be provided based on potential dangers detected in the chart data ahead of the vessel, such as land, rocks, and restricted areas. You can also select Anti-Collision Objects and how far in front of the vessel the area will be scanned based on distance or time.

NOTE

Navionics must be selected as the map source to enable this feature.

Chart View with Anti-Collision Overlay Turned On [Navionics]

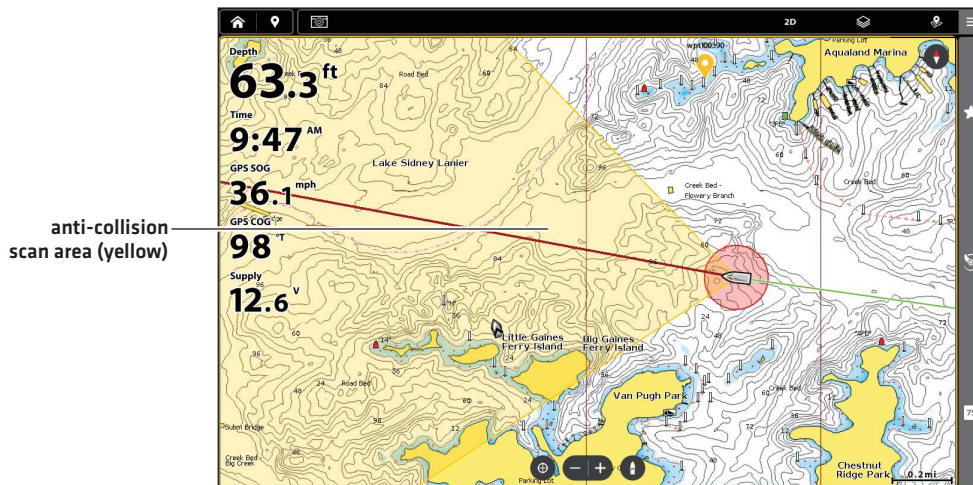

Turn on Anti-Collision

1. Press the HOME key.
2. Select Settings > My Boat > Navigation Settings.
3. Select Anti-Collision. Tap the on/off button, or press the ENTER key, to turn it on.

Use the Anti-Collision default settings, or use the menus in this section to set how the area is searched [Search Parameters, Search [Time] or Search [Distance], and Anti-Collision Objects].

Turn on the Alarm

1. Press the HOME key.
2. Select Tools.
3. Select Alarms.
4. Select Alarms > Navigation.
5. Select Anti-Collision Alarm. Tap the on/off button, or press the ENTER key, to turn it on.

Display the Anti-Collision Overlay

When the overlay is turned off, the scan area is shown only when a danger is detected.

When the overlay is turned on, the scan area is displayed at all times. When a potential danger is detected, the scan area will turn red.

1. With a Chart View displayed on-screen, tap the Menu icon in the Top Bar, or press the MENU key once.
2. Select Settings > Overlays > Vessel.
3. Select Anti-Collision.
4. Tap the check box, or press the ENTER key, to add a check mark and make it visible on the view.

MAN OVERBOARD (MOB) NAVIGATION

As soon as you know that you have a man overboard (MOB), you should activate Man Overboard navigation to maximize the chances for a successful rescue. Man Overboard navigation marks the approximate point where the person went overboard and starts continuous navigation toward the Man Overboard waypoint.

Activate Man Overboard Navigation



1. Press and hold the Man Overboard icon on the Home screen.

Man Overboard Navigation (in progress)

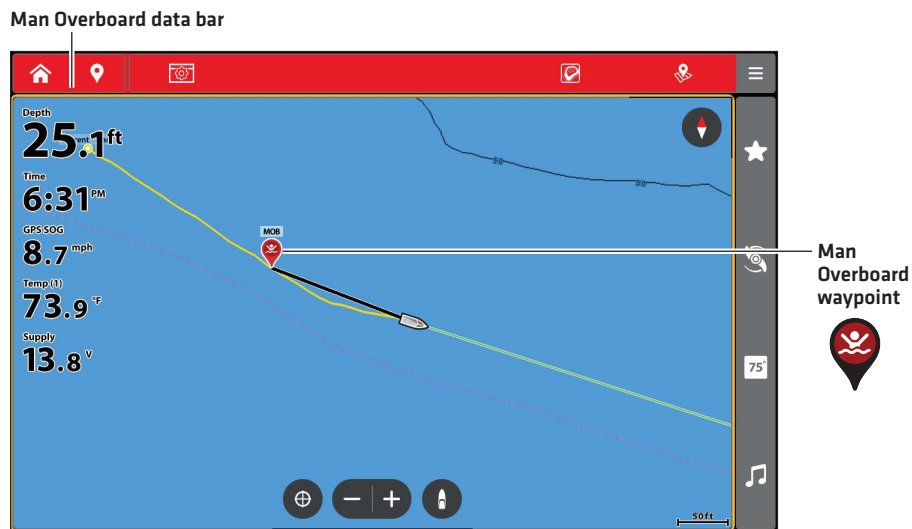

When Man Overboard is activated, any current navigation will be canceled and the current route will be discarded without notification. Man Overboard navigation will begin immediately, and you will see the following on the screen:

Chart View: The view will switch to Chart View automatically.

Man Overboard Waypoint: A waypoint is created at the vessel's current position, regardless of whether the chart cursor is active or not.

Continuous Navigation: The fish finder will begin continuous navigation toward the Man Overboard waypoint.

Auto Zoom: The screen magnifies to show the Man Overboard waypoint and the vessel on the screen.

Data Bar: The data bar will display digital readouts for Man Overboard, including the Distance to Go and Time to Go to the MOB waypoint [DTG + TTG].

Cancel Man Overboard Navigation

1. Press and hold the Cancel Man Overboard icon from the Home screen.

OR

1. With a view displayed on-screen, tap the Menu icon in the Top Bar, or press the MENU key once.
2. Select Cancel Navigation.

INTRODUCTION TO NAVIGATION

Your Humminbird fish finder allows you to mark waypoints, create a route, and start navigating. Waypoints, routes, and tracks can be managed on-screen so you can save your favorites, edit names, and easily return to your favorite destinations.

There are many ways to start navigation or edit navigation data with your Humminbird fish finder. The instructions in this section review navigation features on the Chart View. To use navigation features from the My Data tool, see [Manage your Navigation Data](#).

Chart View with Waypoints, Routes, Tracks



NAVIGATION MENU OVERVIEW

There are many ways to use the navigation features on your fish finder. The Navigation X-Press Menu and Cursor menu are opened using the touch screen. The same menus are also opened by pressing the NAVIGATION/GO TO key or WAYPOINT/MARK key.

This section is an overview of the menus available for navigation. The availability of menu options is determined by the navigation mode and your Humminbird model. To apply these functions, see **Waypoints**, **Spot-Locks**, **Routes**, **Tracks**, and **Search**.

Navigation X-Press Menu

The **Navigation X-Press Menu** allows you to start a Quick Route, navigate to a cursor, route or point, and initiate Minn Kota Motor features (if equipment is connected). The Navigation X-Press Menu is only available in the Chart View, Sonar Views, or Radar View displayed on-screen with Navigation enabled.

Open the Navigation X-Press Menu

1. With a Chart View displayed on-screen, tap the Menu icon in the Top Bar, or press the MENU key once.
2. Select Navigation.
3. Select an action from the sub-menu.

OR

1. With a Chart View displayed on-screen, press the NAVIGATION/GO TO key.
2. Select an action from the sub-menu.

Using the Touch Screen to Open the Navigation X-Press Menu

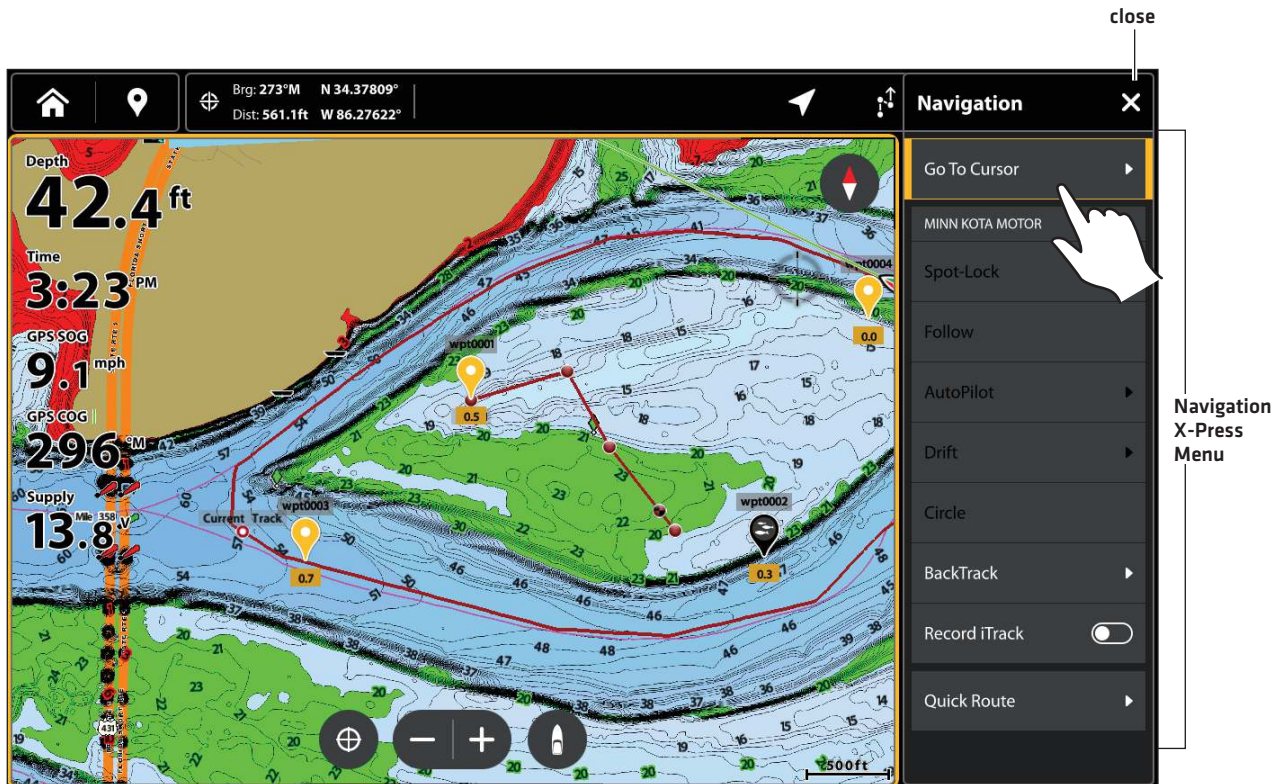

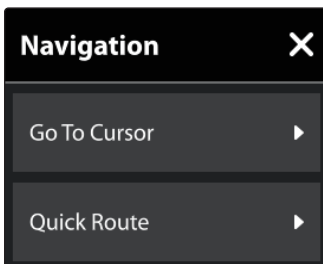

The following options are available from the Navigation X-Press menu when navigation is not in progress. See **Routes** for more information about using this menu.

Navigation X-Press Menu Options	
Go To Cursor	If the cursor is active, navigation will start to the cursor position.
Quick Route	Select Quick Route to mark quick route points and start navigation. See Routes for more information.
Nav Data	Open the My Data tool to select saved navigation data and start navigation.

When the Navigation X-Press menu is opened during navigation, additional menu options are available, including the following:

Navigation X-Press Menu Options (during navigation)	
Cancel Navigation	Select Cancel Navigation to cancel navigation with the fish finder.
Restart Course	Select Restart Course to start navigation from the current vessel position instead of from the first route point. The fish finder will recalculate navigation to the next closest point in the route. This is helpful if the boat has navigated off course from the current route.
Next Point	Select Next Point to skip the current point and navigate to the next route point in the route.
Reverse Route	Select Reverse Route to reverse the currently navigated route. Navigation will start from the vessel position and continue in the opposite order.





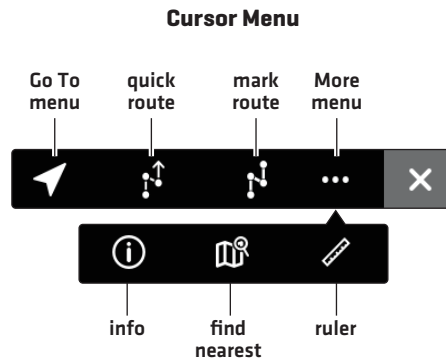

Cursor Menu

The **Cursor menu** is another way to use the touch screen to open the Navigation X-Press menu, create a route, or start a search. The Cursor menu is only available with the 2D Chart View, Sonar Views, or Radar View displayed on-screen.

Open the Cursor Menu

1. Tap a position on the Chart View to activate the cursor, or use the Cursor pad/Joystick to move the cursor to a position on the chart.



Cursor Menu Options	
	Navigation: Opens the Navigation X-Press menu to start or change navigation.
	Quick Route: Starts Quick Route navigation by letting you to connect route points and waypoints and start navigation immediately.
	Mark Route: Create a route in the Chart View and save it for navigation later.
	Ruler: Open ruler to measure distance between two points.
	Find Nearest: Search for nearest waypoints, routes, and tracks.
	Info: Open Map Info menu.

Displaying the Cursor Menu

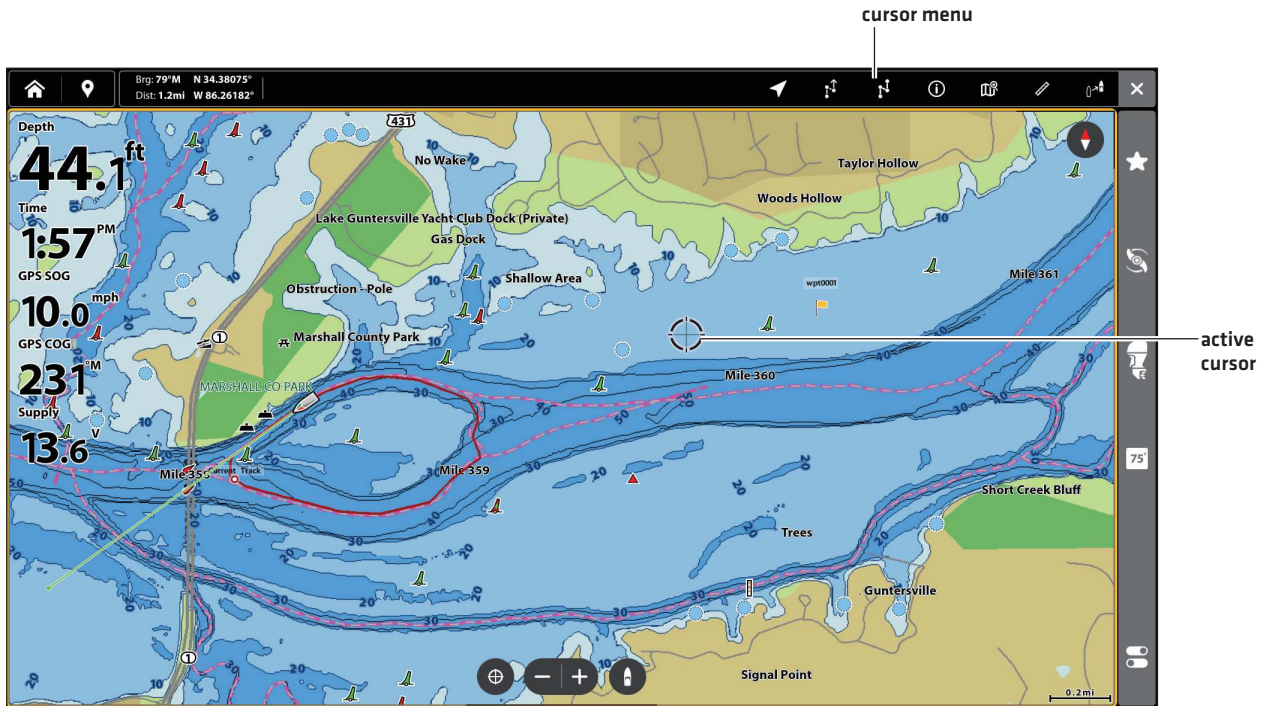

Info Menu

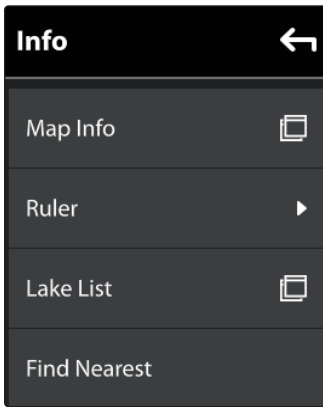

Use the **Info menu** to start a proximity search.

If you are using Humminbird as the map source, you can search lake information. Navionics also has additional search options.

Open the Info Menu

1. With a Chart View displayed on-screen, tap the Menu icon in the Top Bar, or press the MENU key once.
2. Select Info.
3. Select an action from the sub-menu.

NOTE

If you select a waypoint, route, or track with the cursor, and then press the ENTER key, the Info menu for the selected item will display.

Info Menu Options	
Info	Select Info to search the area within a preset range for a variety of data, including cautions, tide stations, current stations, and ports. The available information is determined by the selected map source and the information available in the search area. See Search for more information. [Navionics only]
Ruler	Select Ruler to measure the distance between two positions on the view. Press the ENTER key to select the measurement start point. Move the Cursor pad/Joystick to the second selected position, and press the ENTER key to mark the measurement end point.
Lake List	Select Lake List to search for lakes within a preset range. Humminbird must be selected as the map source. See Search for more information.
Lake Name	Select Lake Name to open the on-screen keyboard and search for a lake by name. Humminbird must be selected as the map source. See Search for more information.
Find Nearest	Select Find Nearest to search the closest waypoints, routes, and tracks within a preset range. See Search for more information.

WAYPOINTS

 Waypoints are saved latitude/longitude positions. They mark a position of interest such as your favorite fishing area, structure, or marker buoy. The fish finder saves the position and allows you to edit the waypoint name, icon, and more [see *Manage your Navigation Data*]. You can save 10,000 waypoints to the fish finder.

Mark Waypoints

Waypoints can be marked at the vessel position or cursor position. To edit the waypoint, see *Edit a Waypoint in the Chart View* or *Manage your Navigation Data*.

Mark a Waypoint at the Vessel Position

1. With a Chart View displayed on screen, tap the Mark icon  in the Top Bar or press the WAYPOINT/MARK key.
2. Select a waypoint color icon and color from the Favorites menu.

Mark a Waypoint at the Cursor Position

1. Tap a position on the Chart View to activate the cursor, or use the Cursor pad/Joystick to move the cursor to a position on the chart.
2. Tap the Mark icon  in the Top Bar or press the WAYPOINT/MARK key.
3. Select a waypoint color icon and color from the Favorites menu.

Marking a Waypoint at the Cursor Position

The Mark menu opens when you press the MARK key or tap the Mark icon from the Top Bar.

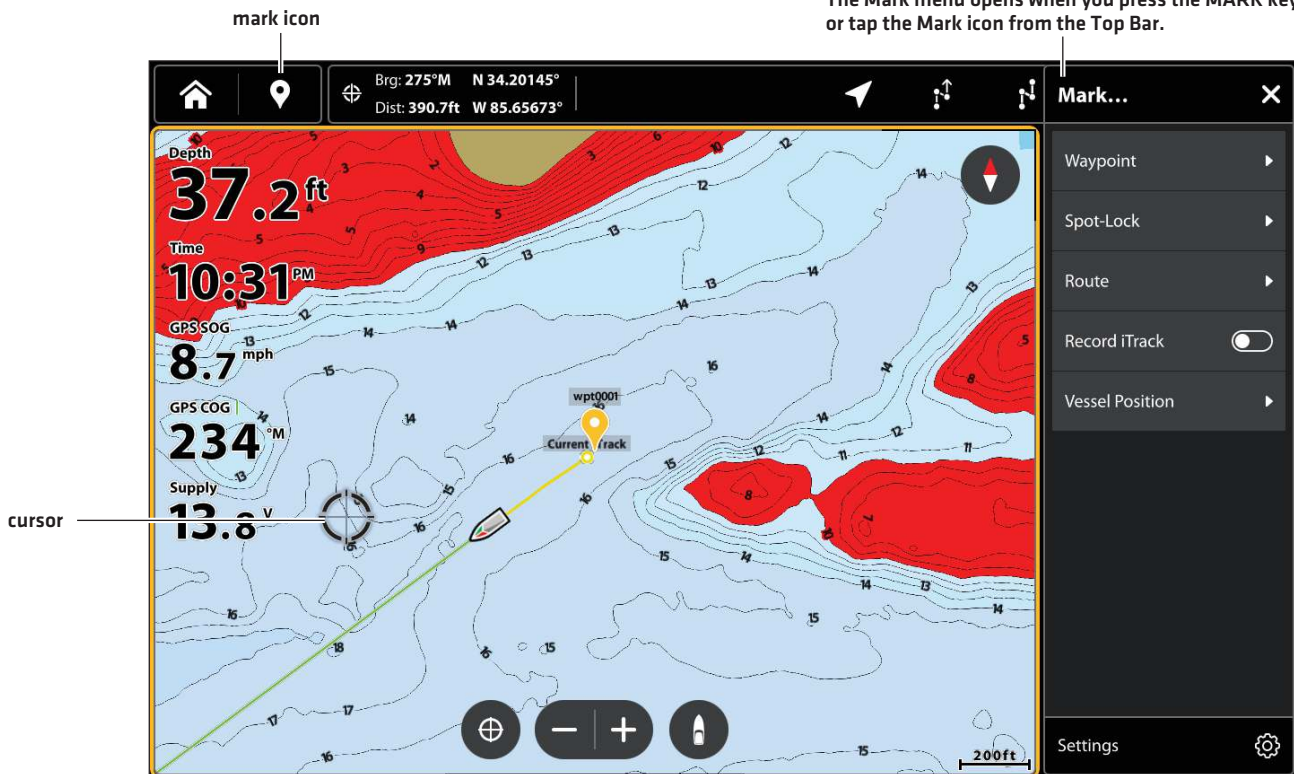

Create Favorite Settings

Use the instructions in this section to preset your favorite icon and color. When you mark a waypoint, you will be given the menu options from your favorite settings to edit the waypoint.

1. Tap the Mark icon  in the Top Bar or press the WAYPOINT/MARK key.
2. Select Favorite Setup.
3. Tap an icon and color or use the Cursor pad/Joystick to make your selections.

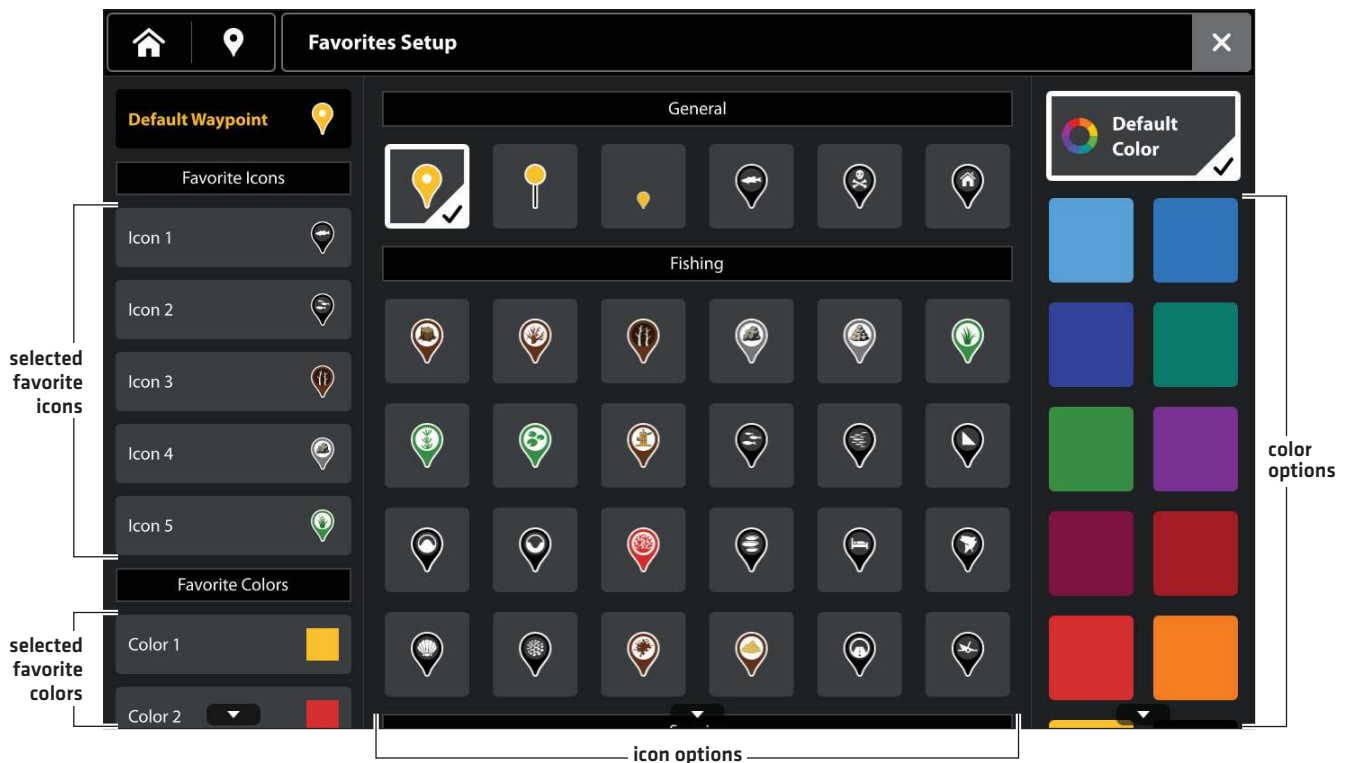
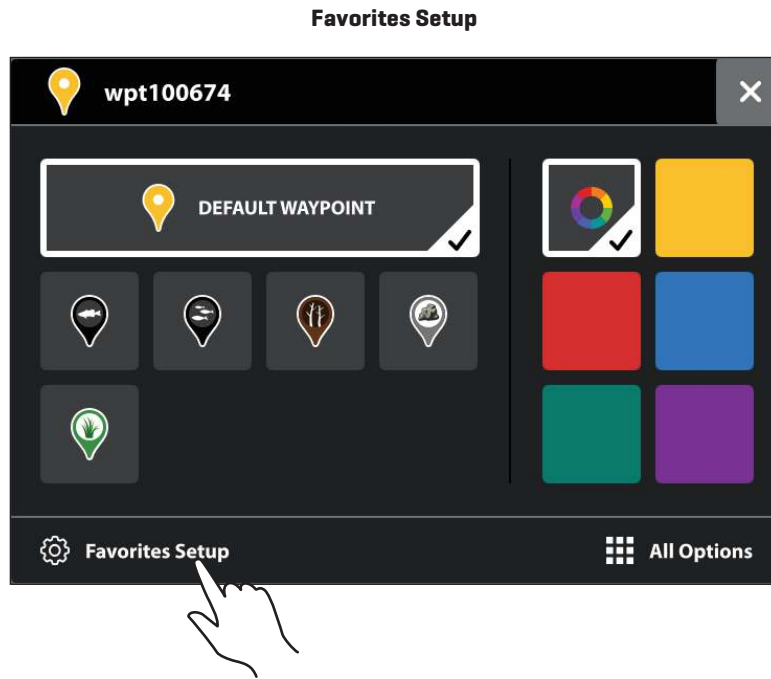

Editing Options for Favorite Waypoint Settings	
Icon	Select 5 icons to be your favorite icons. The icons are grouped by category.
Color	Select 5 colors to be your favorite colors.

Move a Waypoint in the Chart View

1. Tap a waypoint on the chart, or use the Cursor pad/Joystick to move the cursor to a waypoint on the chart.
2. Tap the More icon ●●● in the Cursor menu.
3. Tap Move .
4. Tap a new position on the chart, or use the Cursor pad/Joystick to move the waypoint to a new position.
5. Tap the Check icon ✓ or press the ENTER key to confirm the new position.

Selecting a Waypoint



Selecting Move from the Cursor Menu

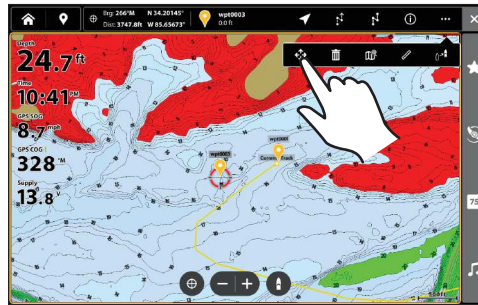

Moving the Waypoint

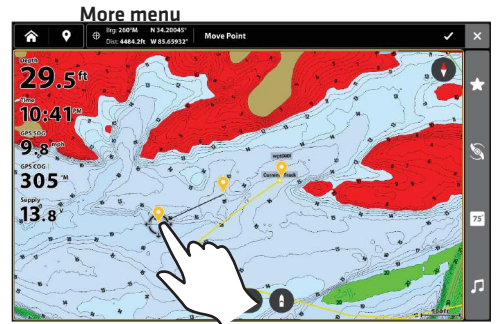

Edit a Waypoint in the Chart View

1. Tap a waypoint on the chart, or use the Cursor pad/Joystick to move the cursor to a waypoint on the chart. The waypoint icon, name and depth will display in the Top Bar.
2. Tap the waypoint in the Top Bar to open the Waypoint Info menu.
3. Edit the waypoint name, icon, color, and more [see *Manage your Navigation Data* for more information].
4. **Close:** Press the EXIT key.

Editing from the Cursor Menu

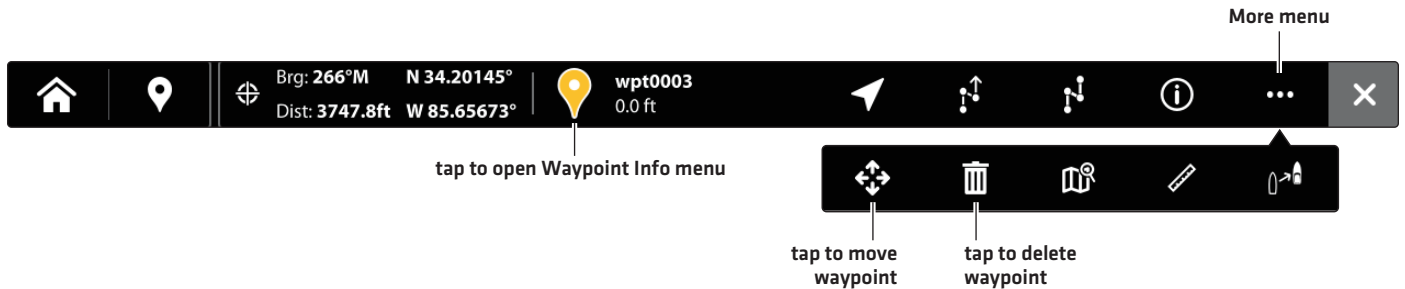

Set the Waypoint Avoidance Radius

An avoidance radius can be set around a selected waypoint. A radius will be highlighted around the waypoint. To receive an alarm when the waypoint avoidance radius has been crossed, turn on the Waypoint Avoidance Alarm [see **Navigation Alarms Overview**].

1. Tap a waypoint on the chart, or use the Cursor pad/Joystick to move the cursor to a waypoint on the chart. The waypoint icon, name and depth will display in the Top Bar.
2. Tap the waypoint in the Top Bar to open the Waypoint Info menu.
3. Under Avoidance, tap the check box, or press the ENTER key, to add a check mark to it.
4. Press and hold the slider, tap the +/- buttons or press the +/- ZOOM key, to adjust the radius setting.
5. **Optional:** To receive an alarm when the radius has been crossed, turn on Waypoint Avoidance in the Navigation Alarms menu [Home > Tools > Alarms > Navigation > Waypoint Avoidance > On].





Delete a Waypoint in the Chart View

1. Tap a waypoint on the chart, or use the Cursor pad/Joystick to move the cursor to a waypoint on the chart.
2. Tap the More icon ●●● in the Cursor menu.
3. Select Delete .

Draw to Select

Use the Draw to Select feature in Chart View to freehand draw around waypoints to select multiple waypoints at one time.

1. With a Chart View displayed on-screen, tap the My Data icon  in the Top Bar.
2. Tap Draw to Select.
3. Use the touchscreen to draw around the waypoints you want to select. The drawn area will be outlined in red.
4. Select an action from the Top Bar.

Editing Options for Selected Waypoints	
	Export: Transfer data to a selected SD card or to the One-Boat Network App.
	Edit Group: Select an existing group or create a new group.
	Edit Icon: Select a new icon for all of the selected waypoints.
	Edit Color: Select a new color for all of the selected waypoints.
	Delete: Delete all of the selected waypoints.

Draw to Select

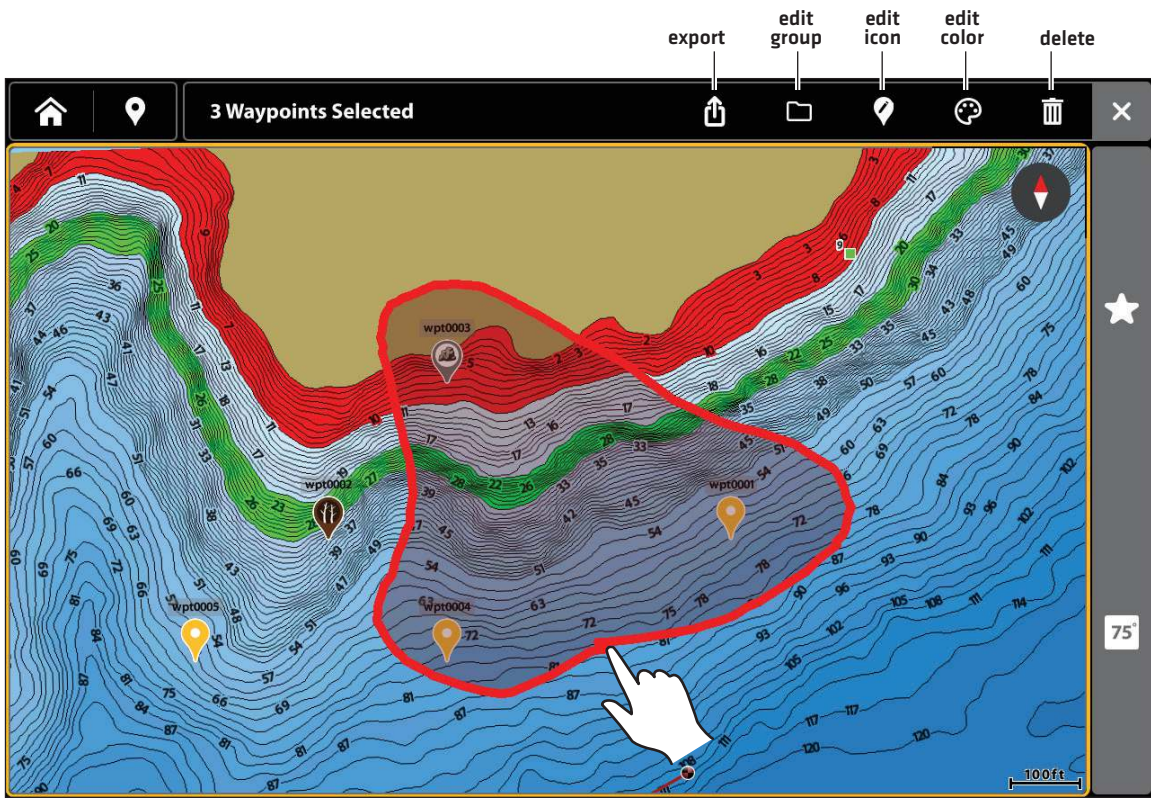

ROUTES



Routes link two or more points together to create a path for navigation. A route represents your intended navigation and shows the shortest path from each data point to the next. The distance between each route point is a **route leg**. You can save 200 routes to the fish finder.



Route Points are stored latitude/longitude positions that connect to form route navigation.



Route Start Point



Route End Point

CAUTION

You should always be aware of your surroundings and watch for any potential obstacles.

Quick Route Navigation



A Quick Route allows you to connect route points and waypoints and start navigation immediately. A Quick Route can be started with the NAVIGATION/GO TO key or with the touch screen. Quick Routes can be saved or discarded. To create a saved route, see **Create a Saved Route** or **Manage your Navigation Data**.

Start Quick Route Navigation from Navigation X-Press Menu





1. **Open the Navigation X-Press Menu:** With a Chart View displayed on-screen, tap the Menu icon in the Top Bar, or press the MENU key once. Select Navigation.

OR

With a Chart View displayed on-screen, NAVIGATION/GO TO key.

2. Select Quick Route.
3. Tap points on the screen to add route points. Use the Route Point icon  or Back icon  to make changes. Select the Check icon  when complete. Navigation will begin.

Start Quick Route Navigation from Cursor Menu

1. Tap a waypoint on the chart, or use the Cursor pad/Joystick to move the cursor to a waypoint on the chart. The waypoint icon, name and depth will display in the Top Bar.
2. Tap the Quick Route icon  in the Cursor Menu.
3. Tap points on the screen to add route points. Use the Route Point icon  or Back icon  to make changes. Select the Check icon  when complete. Navigation will begin.

Marking a Quick Route

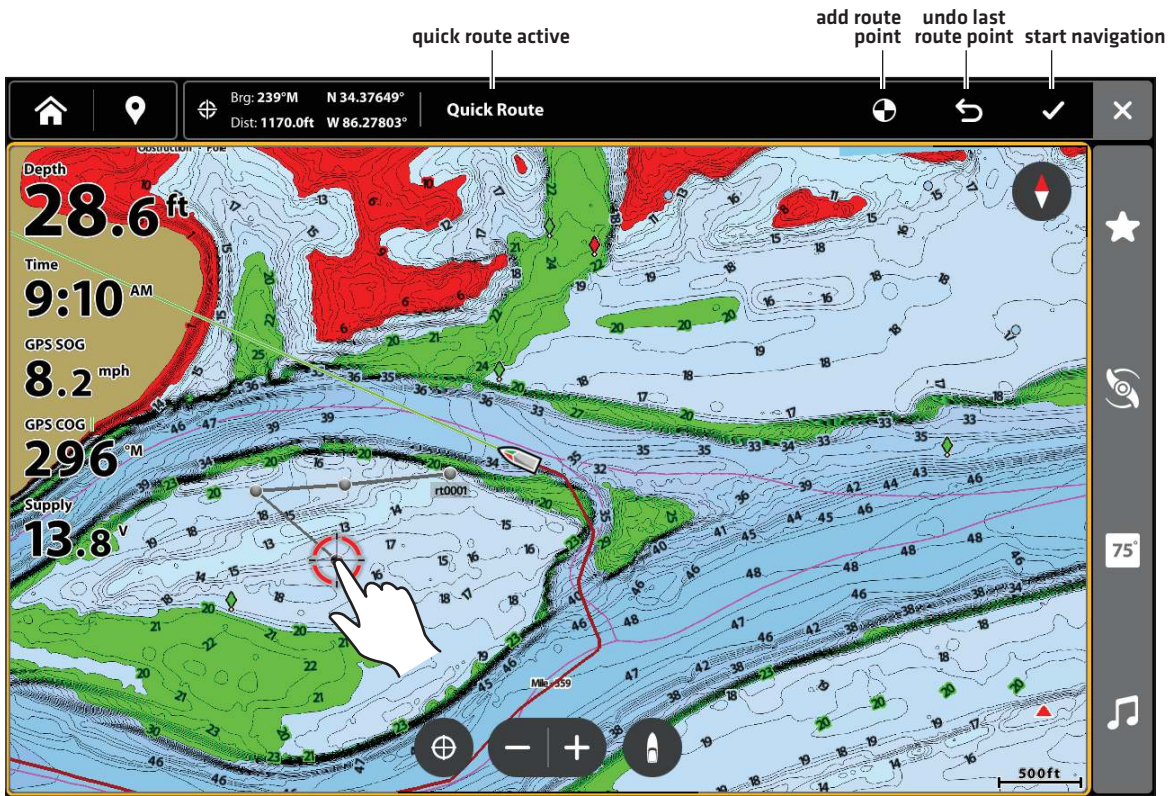

Change Route Order During Navigation

1. During navigation, tap the Menu icon in the Top Bar, or press the MENU key once. Select Navigation.

OR

Press the NAVIGATION/GO TO key.

2. Select one of the following menu options:

Restart Course: Resets navigation to start from the current vessel position to the next point in the route.

Next Point: Skips to the next point in the route.

Reverse Route: Reverses the currently navigated route. Navigation will start from the vessel position and continue in the opposite order.

Cancel Quick Route Navigation

1. During navigation, tap the Menu icon in the Top Bar, or press the MENU key once. Select Navigation.

OR

Press the NAVIGATION/GO TO key.

2. Select Cancel Navigation.
3. Select Save Route or Discard Route.

Canceling Quick Route Navigation

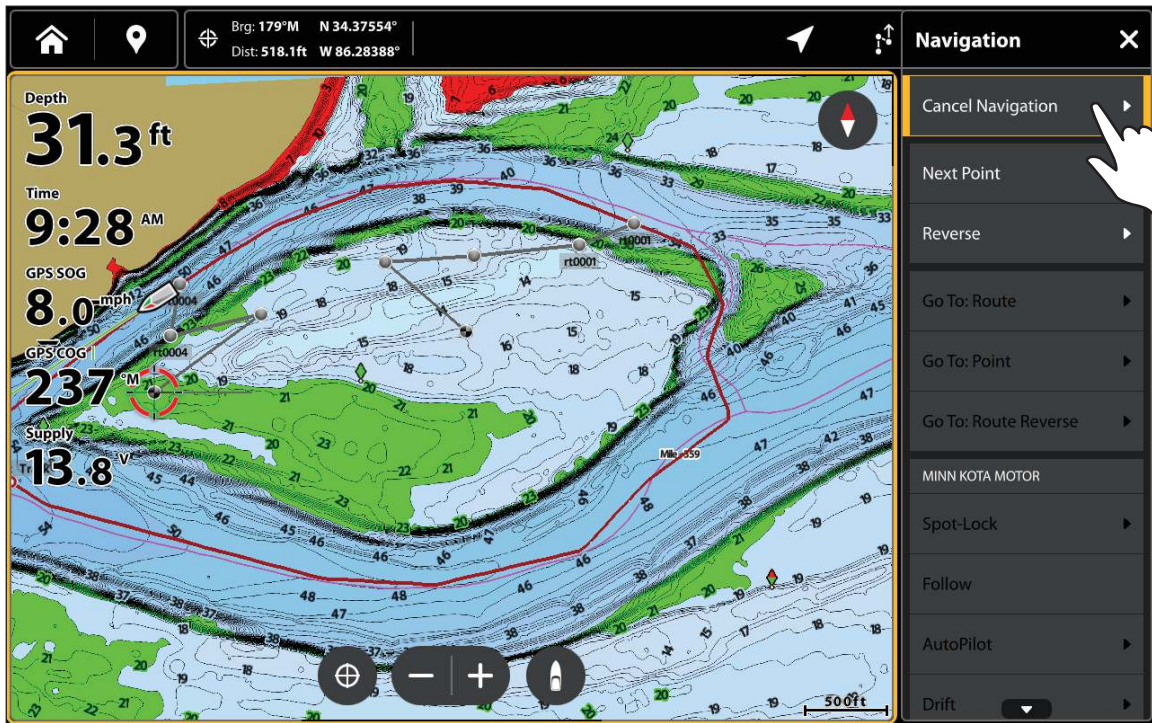

Start Navigation to a Saved Waypoint or Route

Use the cursor to select a saved waypoint or route point on the Chart View, and you can start navigation to it. If you select a route point, you can also choose a navigation order for the selected route.

Start Navigation

1. Tap a waypoint or route point on the chart, or use the Cursor pad/Joystick to move the cursor to a waypoint or route point on the chart.
2. Tap the Navigation icon  in the Top Bar or press the NAVIGATION/GO TO key.
3. Select Go To: Route or Go To: Point.

Cancel Navigation: Tap the Navigation icon  or press the NAVIGATION/GO TO key. Select Cancel Navigation.

Create a Saved Route





The instructions in this section allow you to create a route in the Chart View and save it for navigation later. The steps are similar to creating a Quick Route, but you will use the Mark Route icon  in the Cursor menu.

Save Location: The route is saved to the My Data tool.

Navigation: To start navigation on the route, see *Start Navigation to a Saved Waypoint or Route*.

Overlay: To display saved routes on the Chart View, press the MENU key once. Select Chart Options > Overlays > Nav Data > Routes [Saved].

Create a Saved Route

1. Activate the cursor on the chart using the touchscreen or cursor pad.
2. Tap the Mark Route icon  in the Cursor Menu.
3. Tap points on the screen to add route points. Use the Route Point icon  or Back icon  to make changes. Select the Check icon  to save the route.

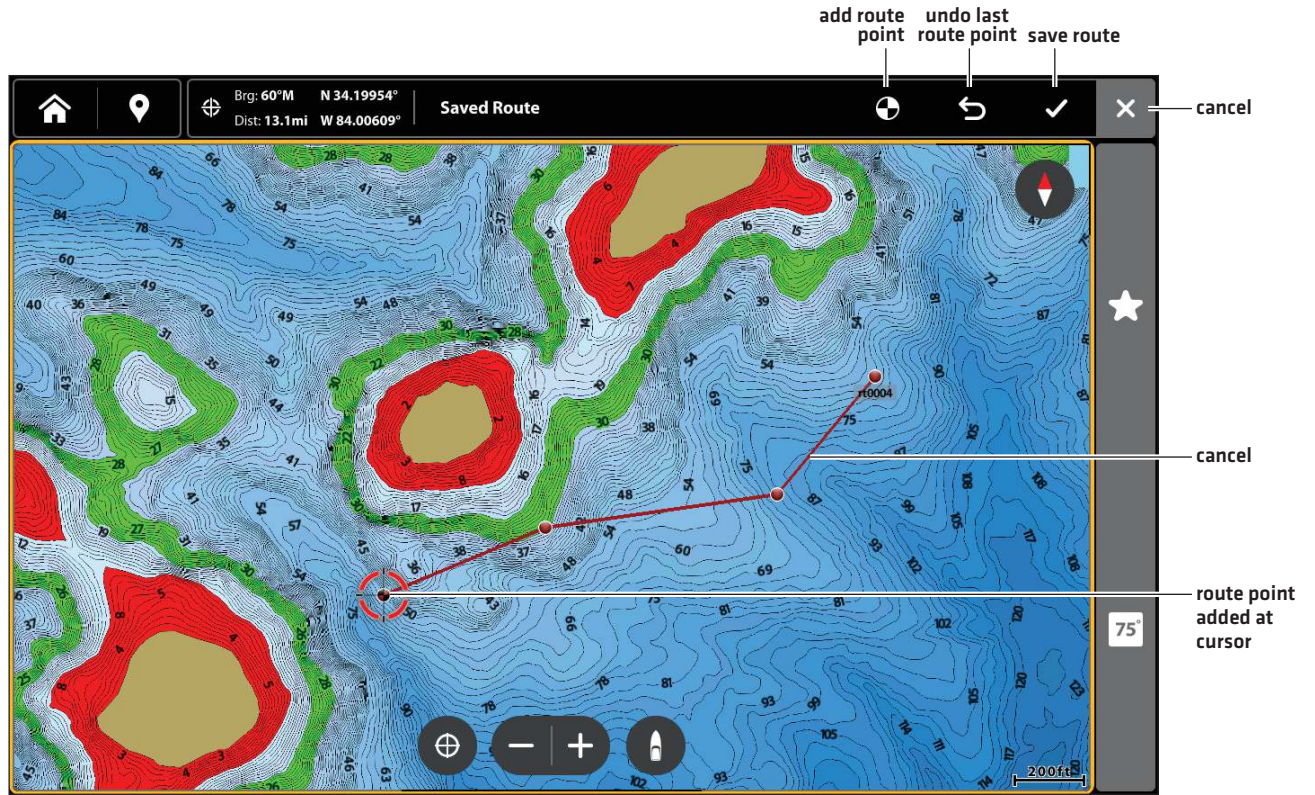

Creating a Saved Route



Edit a Route in the Chart View

1. Tap the route to select it.
OR
Use the Cursor pad/Joystick to move the cursor to a route on the chart. Press the ENTER key.
2. Use the Route Info menu to edit the route name, color, and more [see *Manage your Navigation Data* for more information].
3. **Close:** Press the EXIT key.

Add or Delete Points in a Route

1. Tap the route to select it. Tap the Route Name.
OR
Use the Cursor pad/Joystick to move the cursor to a route on the chart.
2. Tap the More icon  in the Cursor menu.
3. Tap the Edit icon .
4. Select Add Point or Extend Route From Finish or Extend Route From Start.

Delete a Route in the Chart View

1. Tap the route to select it.

OR

Use the Cursor pad/Joystick to move the cursor to a route on the chart.

2. Tap the More icon ●●● in the Cursor menu.

3. Tap the Delete icon 🗑️.

Editing a Route on the Chart View

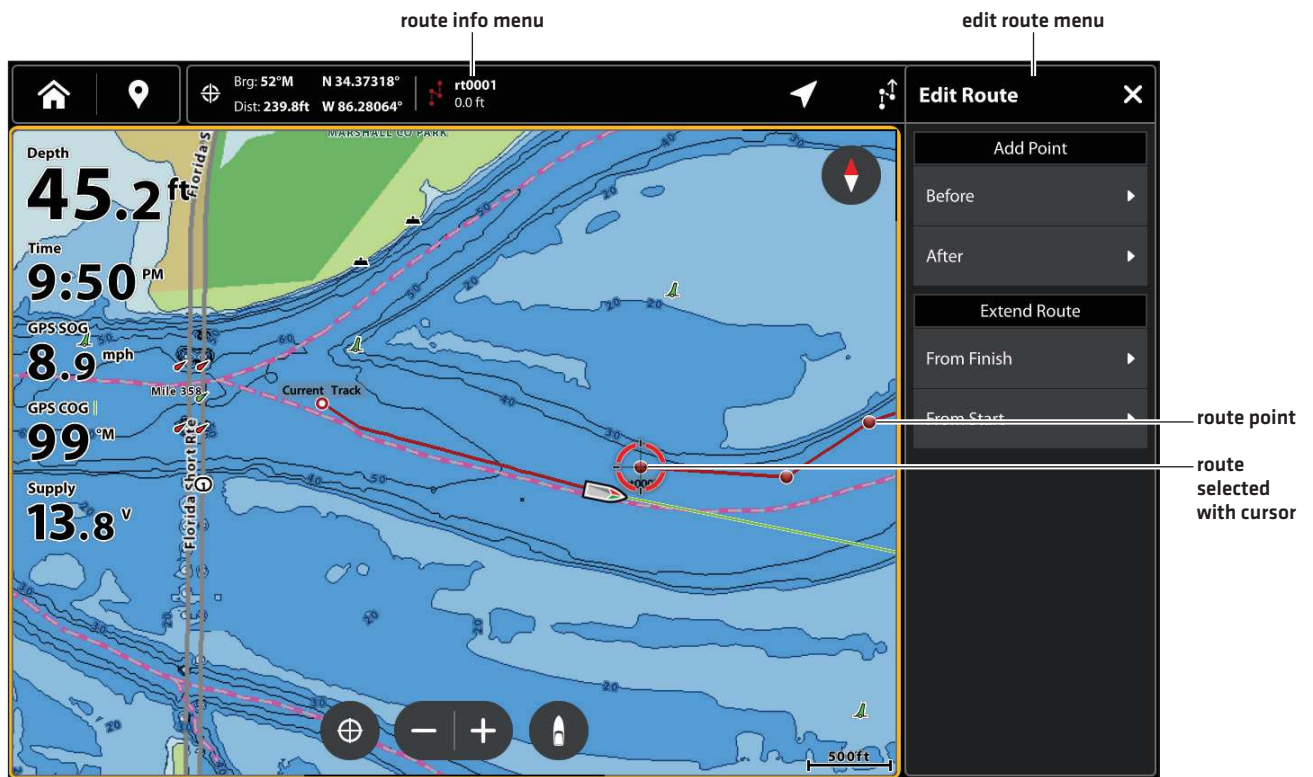

SEARCH

There are many ways to search the area for ports, services, tide stations, current stations, and other points of interest. You can also search the nearest waypoints, routes, and tracks. In many cases, you can also use the Navigation menu to start navigation to your selection. The search options and the search area distance are determined by the selected map source.

NOTE

For more information about the ENTER key and the Info menu, see *Navigation Menu Overview*.

Search for a Lake

If Humminbird is selected as the map source, you can search for lakes in the area.

1. With a Chart View displayed on-screen, tap the Menu icon in the Top Bar, or press the MENU key once.
2. Select Info.
3. Select Lake List.
4. Select an item from the displayed list.

OR

To search by name, select Lake Name. Use the on-screen keyboard to enter a name.

Find the Nearest Navigation Data

Use the Find Nearest menu to search for the ports, services, tide stations, current stations, and other points of interest.

1. With a Chart View displayed on-screen, tap the Menu icon in the Top Bar, or press the MENU key once.
2. Select Info.
3. Select Find Nearest.
4. Select an item from the displayed list. Tap the item, or press the ENTER key, to see more information if it is available.
5. To start navigation to your selection, press the NAVIGATION/GO TO key.

OR

1. Tap a position on the Chart View.

OR

Use the Cursor pad/Joystick to move the cursor to a position on the Chart View.

2. Select Find Nearest  in the Cursor Menu.
3. Choose an item from the displayed list. Tap the item, or press the ENTER key, to see more information if it is available.
4. To start navigation to your selection, press the NAVIGATION/GO TO key.

TRACKS



A track is a collection of track points that contains the vessel's detailed position history at set intervals. The Current Track shows the position history since the fish finder was powered on. Record Track must be turned on to enable this feature [see **Record a Track**]. You can clear the Current Track or save it at any time. To change the track point interval, edit saved tracks, and create track settings, see **Manage your Navigation Data**. You can save 50 tracks (each with 20,000 track points) to the fish finder.



Start Point



End Point

Set up Tracks

Your fish finder is set to record tracks and display them on the view. Use the instructions in this section if you've changed the fish finder default settings.

Record a Track

When Record Track is turned on, the fish finder will save the current track. If Record Track is turned off, the track will not be recorded or saved.

1. Press the HOME key.
2. Select My Data tool.
3. Select My Data Settings.
4. Select Tracks.
5. Select Record Track. Tap the on/off button, or press the ENTER key, to turn it on.

Display Tracks on the Chart View

You can display saved tracks or active tracks on the Chart View.

1. With a Chart View displayed on-screen, tap the Menu icon in the Top Bar, or press the MENU key once.
2. Select Settings.
3. Select Overlays > Nav Data.
4. Add a check mark to Tracks [Active] or Tracks [Saved] to make them visible on the Chart View.

NOTE

To set an individual track to visible or hidden, see **Manage your Navigation Data: Edit a Saved Track**.

Save the Current Track

Use the following instructions to save the current track and start a new track.

1. With a Chart View displayed on-screen, tap the Menu icon in the Top Bar, or press the MENU key once.
2. Select Current Track.
3. Select Save Current Track.

NOTE

You can also start a new track from the Nav Data tool. See *Manage your Navigation Data: Manage Tracks*.

Clear the Current Track

Use the following instructions to clear the current track and start a new track at the current vessel position.

1. With a Chart View displayed on-screen, tap the Menu icon in the Top Bar, or press the MENU key once.
2. Select Current Track.
3. Select Clear Current Track.

Chart View with a Track Displayed

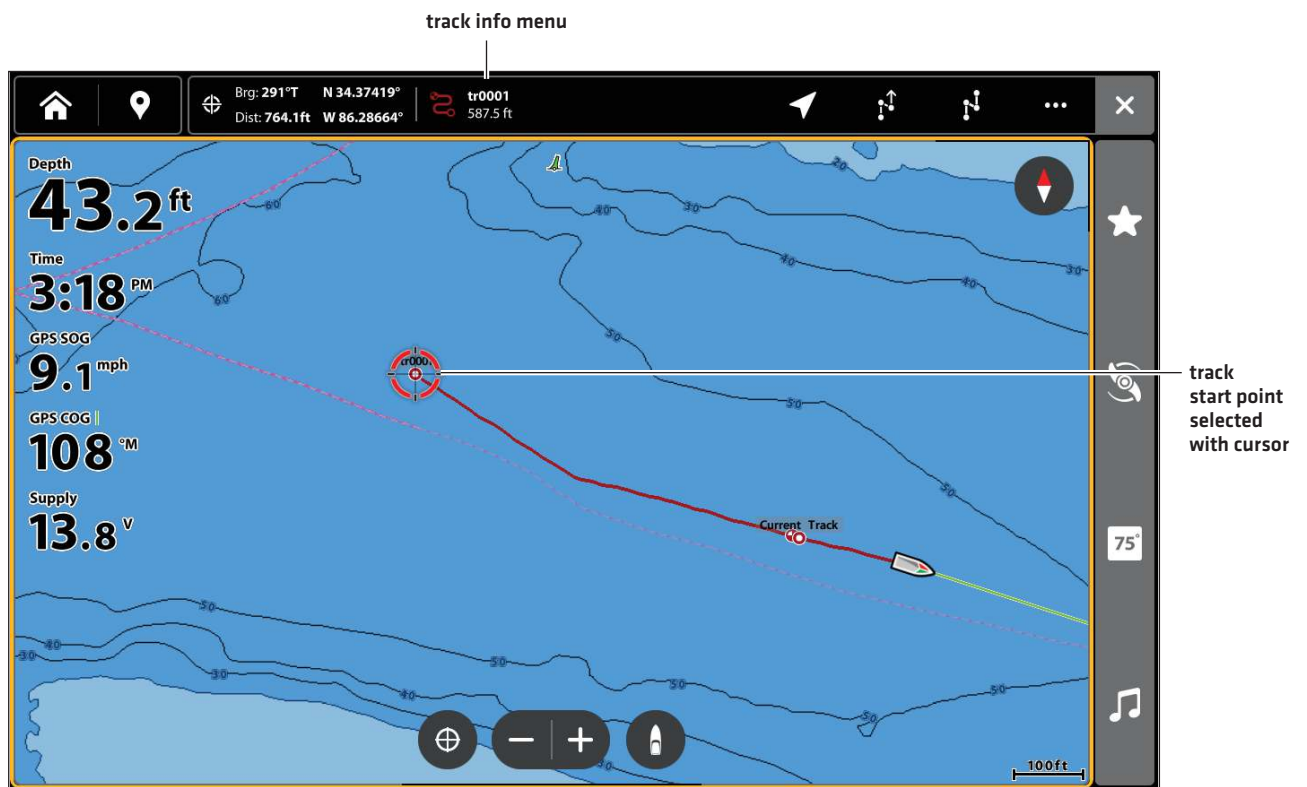

Edit a Track in the Chart View

1. Tap a track start point or end point, or use the Cursor pad/Joystick to move the cursor to a track start point or end point.
2. Tap the Track name in the Top Bar. The Track Info menu will open.
3. Edit the track name, style, color, and more from the Track Info menu.
4. **Close:** Press the EXIT key.

NOTE

To change the default appearance for new tracks, or to change the Track Point Interval, see *Manage your Navigation Data: Manage Tracks*.

Delete a Saved Track

When you delete a saved track, it is permanently deleted from the control head.

1. Tap a track start point or end point, or use the Cursor pad/Joystick to move the cursor to a track start point or end point.
2. Tap the More icon ●●● in the Cursor menu.
3. Tap the Delete icon .

MANAGE YOUR NAVIGATION DATA

Use the My Data tool to manage your saved waypoints, spot-locks, routes, and tracks. You can edit your saved navigation data and start navigation from this tool.

Open the My Data Tool

1. Press the HOME key.
2. Select the My Data tool .

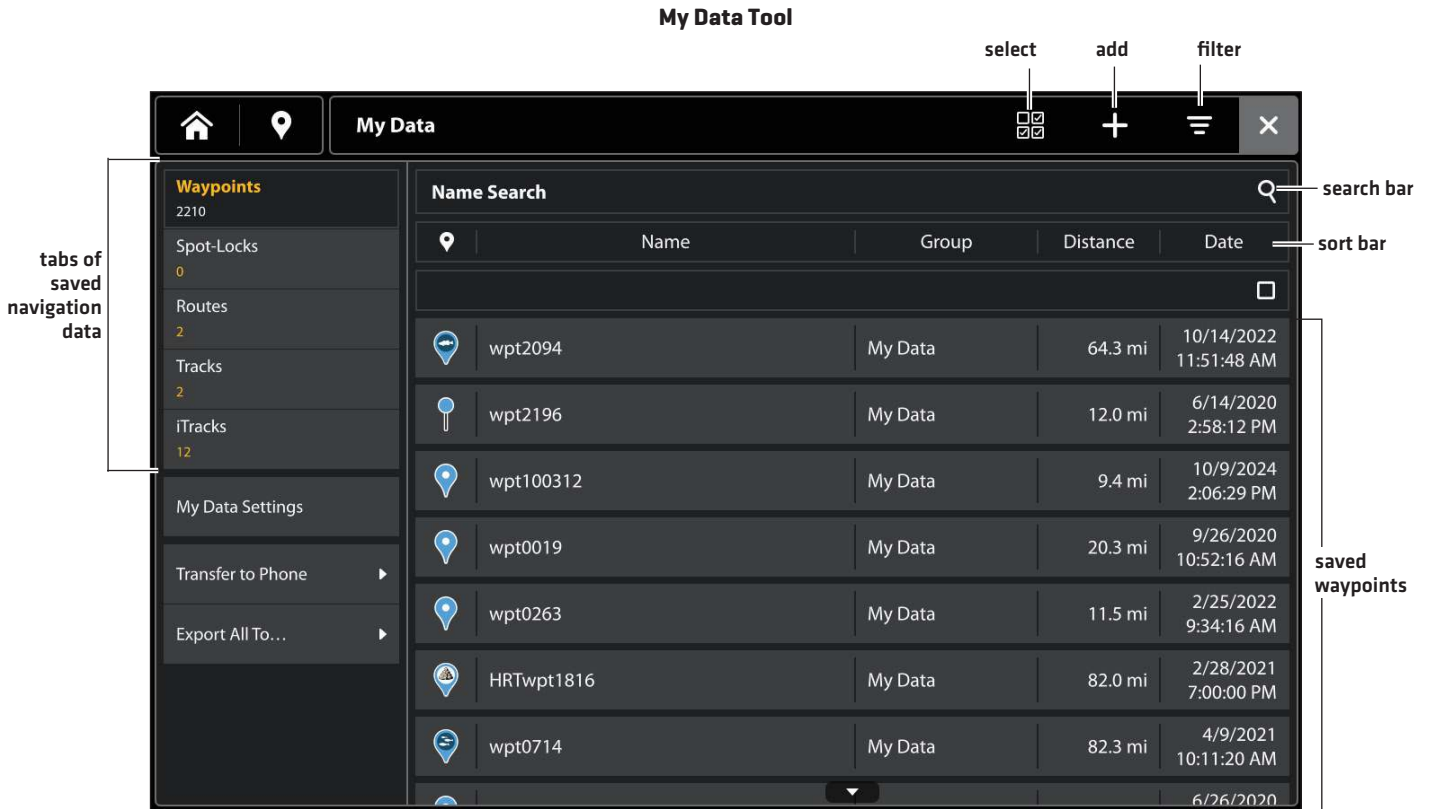

Sort Lists

1. Select a navigation data tab: Waypoints, Spot-Locks, Routes, Tracks or iTracks.
2. Tap a column name, or move the Cursor pad/Joystick and press it on a column name. The first tap will sort the column low to high or A to Z. The second tap will sort it high to low or Z to A.

Filter Lists

1. Select a navigation data tab: Waypoints, Spot-Locks, Routes, Tracks or iTracks.
2. Tap the Filter icon  in the Top Bar.
3. Select a category.

Select Data

1. Select a navigation data tab: Waypoints, Spot-Locks, Routes, Tracks or iTracks.
2. Tap the Select icon  in the Top Bar.
3. Select Select All to select each data point in the list.
4. Select an option from the Top Bar to apply to all selected data.

Add

1. Select a navigation data tab: Waypoints, Spot-Locks, Routes, Tracks or iTracks.
2. Tap the Add icon **+** in the Top Bar.
3. Select one of the following menu options:

Add Menu Actions	
Waypoint at Position	Adds a Waypoint at the keyed in latitude and longitude.
Group	Adds the selected data to a new or existing group.
Import Nav Data	Transfer data to the selected media.

Open the Data Info Menu

1. Select a navigation data tab: Waypoints, Spot-Locks, Routes, Tracks or iTracks.
2. Tap one of the data points.

Info Menu Actions

Tapping on a navigation data point will open the Info Menu. Use this menu to edit information about the navigation point and to start one of the following actions:

Info Menu Actions	
Cursor To	Select to display cursor at the data point in chart view.
Navigation	Select to start navigation to the selected waypoint, spot-lock, route or track.
Delete	Select to delete the selected navigation data.
Export	Select to export navigation data to an SD card or to the One-Boat Network App.

Waypoint Info Menu

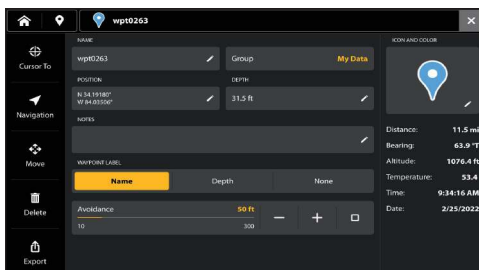

Route Info Menu

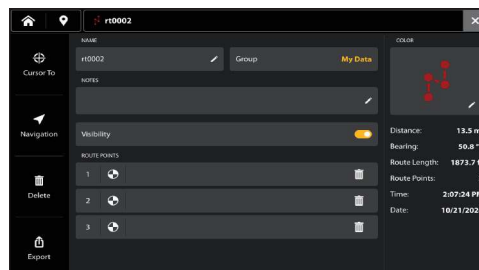

Track Info Menu

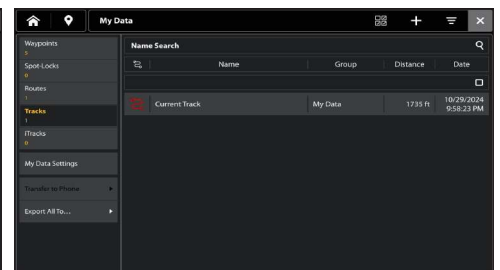

Manage Waypoints

Edit a Waypoint

1. Select the Waypoints tab.
2. Tap a waypoint, or use the Cursor pad/Joystick to select a waypoint and press the ENTER key. The Waypoint Info Menu will open.
3. Select the Edit icon  in the field you want to edit.

Editing Options for Saved Waypoints	
Waypoint Name	Select the waypoint name and use the on-screen keyboard to change it.
Icon and Color	Select an icon category (water, fishing, navigation, POI [point of interest], etc.) and select an icon to represent the selected waypoint. Then, select a color to represent the waypoint.
Group Name	The menu name will vary with the default group name. Select the group name to change where the selected waypoint is saved. See Groups for more information.
Position	Use the on-screen keyboard to edit the latitude/longitude position of the waypoint.
Depth	Use the on-screen keyboard to enter a depth for the waypoint if it was not marked at the vessel position.
Notes	Use the on-screen keyboard to add notes about the waypoint.
Waypoint Label	Select if the waypoint should be labeled by name or depth or have no label.
Avoidance	Add a check mark to the Avoidance box to display the Waypoint Avoidance Radius. Adjust the radius by tapping the +/- buttons or using the slider.

Waypoint Info Menu

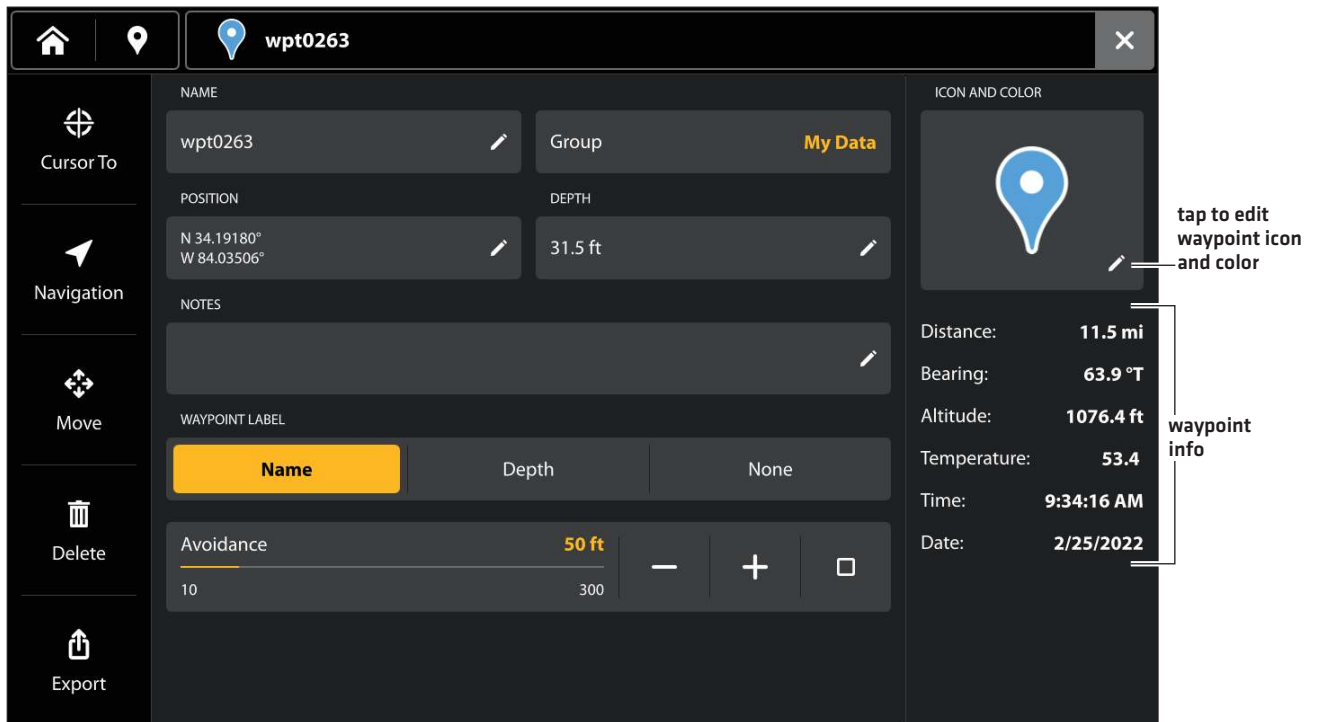

Delete a Waypoint

1. Select the Waypoints tab.
2. Tap a waypoint. The Waypoint Info Menu will open.
3. Tap Delete.

OR

1. Select the Waypoints tab.
2. Tap and hold on a waypoint [or multiple waypoints] to select it. There will be a check mark next to the waypoint.
3. Tap Delete in the Top Bar.

Navigate to a Selected Waypoint

1. Select the Waypoints tab.
2. Tap a waypoint. The Waypoint Info Menu will open.
3. Tap Navigation.

Manage Routes

Edit a Route

1. Select the Routes tab.
2. Tap a route, or use the Cursor pad/Joystick to select a route and press the ENTER key. The Route Info Menu will open.
3. Select the Edit icon  in the field you want to edit.

Editing Options for Saved Routes	
Route Name	Select the route name and use the on-screen keyboard to change it.
Color	Select a color to represent the route.
Group Name	The menu name will vary with the default group name. Select the group name to change where the selected waypoint is saved. See Groups for more information.
Notes	Use the on-screen keyboard to add notes about the route.
Visibility	To display the route on the view, select On. To hide the route on the view, select Off.
Route Points	Tap the Delete icon to delete a specific point in the route.

Route Info Menu

The screenshot shows the 'Route Info Menu' for route 'rt0002'. The interface is divided into several sections:

- Left Sidebar:** Contains navigation and management icons: 'Cursor To', 'Navigation', 'Delete', and 'Export'.
- Top Bar:** Shows the route name 'rt0002' and the group 'My Data'.
- NAME:** 'rt0002' with an edit icon.
- GROUP:** 'My Data'.
- NOTES:** A text input field with an edit icon.
- Visibility:** A toggle switch that is currently turned on.
- ROUTE POINTS:** A list of three points, each with a circular icon and a delete icon.
- COLOR:** A red color selection icon with an edit icon.
- ROUTE INFO:** A section containing statistics: Distance: 13.5 mi, Bearing: 50.8 °T, Route Length: 1873.7 ft, Route Points: 3, Time: 2:07:24 PM, Date: 10/21/2024.

Annotations on the left side of the image:

- 'turn route visibility on/off' points to the 'Visibility' toggle.
- 'delete route' points to the 'Delete' icon in the sidebar.
- 'delete individual point in route' points to the delete icon for the third route point.
- 'edit route color' points to the color selection icon.
- 'route info' points to the statistics section.

Change Default Settings for New Routes

1. In the My Data tool, select My Data Settings.
2. Select Routes.
3. Select the default color and group.
4. **Optional:** Select Restart Route Numbering to restart the numbering sequence at rt0001.

Route Default Settings

The screenshot shows the 'My Data Settings > Routes' screen. The interface is divided into two main sections:

- Left Sidebar:** Lists various settings categories with their counts: Waypoints (2211), Spot-Locks (0), Routes (2), Tracks (2), and iTracks (12). The 'My Data Settings' option is highlighted.
- Main Area:** Shows the 'Route Default Settings' for 'Routes'. It includes:
 - Default Color:** A red color selection icon.
 - Default Group:** 'My Data'.
 - Restart Route Numbering:** A toggle switch that is currently turned off.

Delete a Route Point

1. Select the Routes tab.
2. Tap a route, or use the Cursor pad/Joystick to select a route and press the ENTER key. The Route Info Menu will open.
3. Select a point in the route to delete and tap the Delete icon.

Delete a Route

1. Select the Routes tab.
2. Tap a route. The Route Info Menu will open.
3. Tap Delete.

OR

1. Select the Routes tab.
2. Tap and hold on a route [or multiple routes] to select it. There will be a check mark next to the route.
3. Tap Delete in the Top Bar.

Navigate a Selected Route

1. Select the Routes tab.
2. Tap a route. The Route Info Menu will open.
3. Tap Navigation.

Track Options for the Current Track

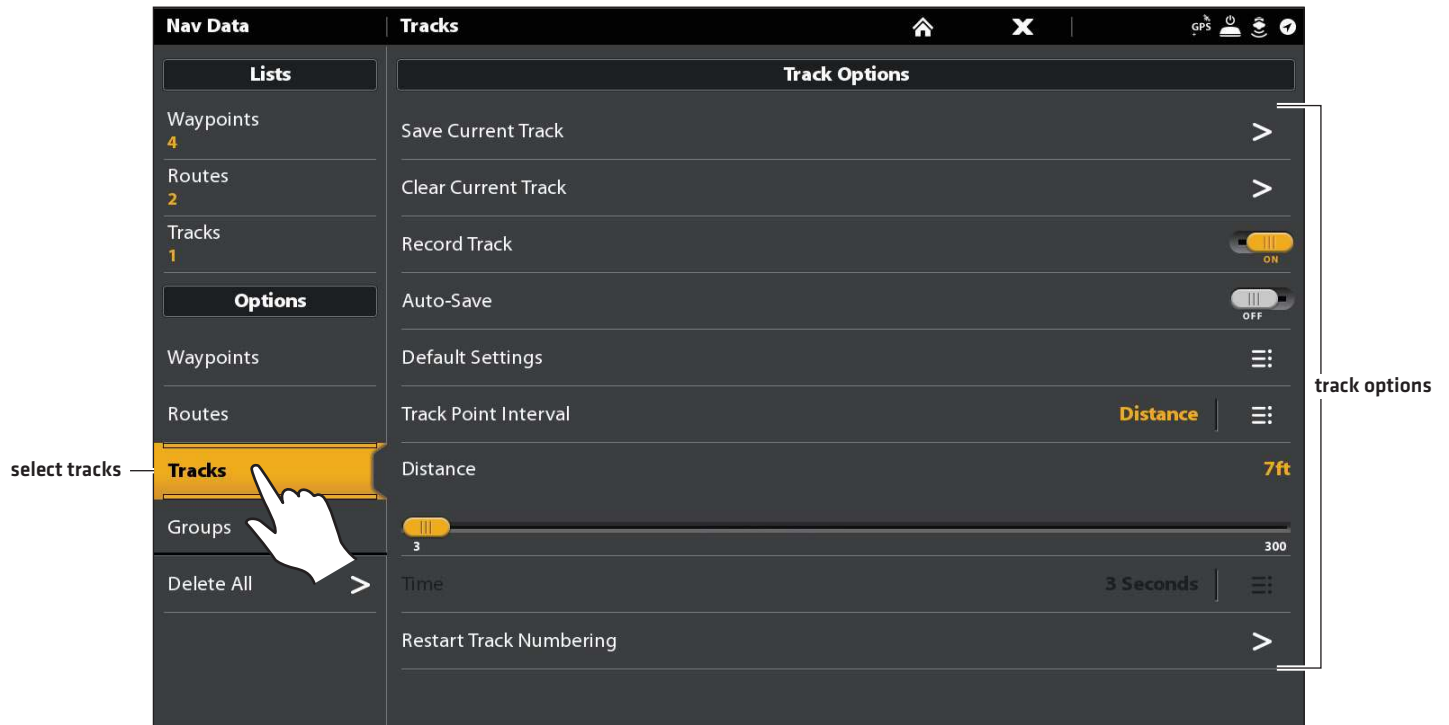

Start a New Track

The Record Track menu must be turned on to enable this feature.

1. Under Options, select Tracks.
2. Select New Track.

Record a Track

When Record Track is turned on, the control head will save the current track. If you power off the control head and then power on the control head at a different position, there might be gaps in the track.

If Record Track is turned off, the track will not be displayed on the Chart View, and the track will not be recorded or saved.

1. Under Options, select Tracks.
2. Select Record Track. Tap the on/off button, or press the ENTER key, to turn it on.

Auto-Save

When Auto-Save is turned on, the control head will save the current track each time the control head is powered off, and a new track will be started when the control head is powered on again.

When Auto-Save is turned off, the current track will continue until you save it [see **Tracks: Save the Current Track**].

1. Under Options, select Tracks.
2. Select Record Track. Tap the on/off button, or press the ENTER key, to turn it on. The control head will start recording the current track at the moment the menu is turned on.

Change Default Settings for New Tracks

1. Under Options, select Tracks.
2. Select Default Settings.

Changing the Default Settings for New Tracks	
Style	Select a line style.
Color	Select a color.
Group	Select the group name to change where tracks will be saved. You can also open a new group from this menu. See Groups for more information.

Change the Track Point Interval

1. Under Options, select Tracks.
2. Select Track Point Interval.
3. Select Distance or Time.
4. Select the Back icon on the status bar, or select the Tracks tab under Options to return to the Track Options menu.
5. If you selected Distance in step 3, adjust the Distance slider to adjust the distance between track points.
If you selected Time in step 3, select Time and open the menu. Select the amount of time between track points.

Edit a Saved Track

1. Under Lists, select Tracks.
2. Press and hold a track. Select Info.

OR

Use the Joystick to select a track. Press the ENTER key.

3. Edit the saved track using the options in the Track Info menu.
To see the complete list of options to edit the track, select Full Info.

Editing Options for a Saved Track	
Track Name	Select the track name and use the on-screen keyboard to change it.
Style	Select a line style.
Color	Select a color.
Visibility	To display the track on the Chart Views, select On. To hide the track on the Chart Views, select Off.
My Data [Group Name]	The menu name will vary with the default group name. Select the group name to change where the selected track is saved. See Groups for more information.
Edit Notes [select Full Info]	Use the on-screen keyboard to add notes about the selected track.

Delete a Track

1. Under Lists, select Tracks.
2. Press and hold a track. Select Delete.

OR

1. Use the Joystick to select a track. Press the ENTER key.
2. Select Full Info.
3. Select Delete Track.

Manage Groups

Use Groups to organize your navigation data (waypoints, routes, and tracks) in one set. Some anglers prefer to group their navigation data by trip, fish-type, body of water, or time of day. Your fish finder can hold up to 50 groups.

Default Group: Your navigation data is saved to My Data, the default group for your fish finder. You can create new groups and save new navigation data to them. You can also move saved navigation data to a different group.

Create a New Group



1. Press the HOME key.
2. Select the My Data tool.
3. Select My Data Settings.
4. Select Groups.
5. Select New Group.
6. Use the on-screen keyboard to name the new group.
7. Select Save.

Set the Default Group

Your navigation data is saved to My Data as the default group. The instructions in this section allow you to save your new navigation data to a different group, so as a waypoint, route, or track is saved, it will be saved to the group you've set up. You can assign waypoints, routes, and tracks to different groups, or you can assign them to the same group.

1. Press the HOME key.
2. Select the My Data tool.
3. Select My Data Settings.
4. Select Waypoints, Spot-Locks, Routes, Tracks or iTracks.
5. Select Group.
6. Select a group from the list.
To create a new group, select New Group.
7. Repeat these instructions for each type of navigation data.

Move Navigation Data to a Group

1. Press the HOME key.
2. Select the My Data tool.
3. Tap a saved item or use the Selection tool  to select multiple items.
4. Select the Group icon  from the Top Bar.
5. Select a group from the list.
To create a new group, select New Group.

QUICK TIP! The Group can also be changed from the Navigation Data Info Menu.

Delete All Navigation Data

The Delete All menu allows you to select a navigation data category and delete all items in that category. For example, if you select Delete All > Waypoints, all saved waypoints will be deleted.

To delete individual waypoints, or other individual navigation items, see the previous sections of *Manage your Navigation Data*.

CAUTION

Use this menu with caution!

1. Press the HOME key.
2. Select the My Data tool.
3. Select Delete.
4. Select a category. **Follow the on-screen prompts to confirm the deletion.**

Import/Export Navigation Data

Your fish finder allows you to export your waypoints, spot-locks, routes, and tracks, so you can view the data on your personal computer. You can also import your navigation data.

Import Navigation Data

Requirements: Humminbird navigation data saved as a GPX file.

1. Install the SD card [with navigation data] into the front fish finder port.
2. Press the HOME key.
3. Select the My Data tool.
4. Select Import.
5. Select a .GPX file. The navigation data will be imported to the fish finder.

Export Navigation Data

1. Install a formatted SD card into the front fish finder port or have the One-Boat Network App synced to your fish finder.
2. Press the HOME key.
3. Select the My Data tool.
4. Select Export All To...
5. **Select a Save Location:** Select which SD Card to save the data to, or select to transfer the data to the One-Boat Network App. All saved navigation data will be exported to the selected location.

AUTOCHART LIVE OVERVIEW

AutoChart Live uses data from an installed GPS receiver and 2D transducer (down beam, digital CHIRP or single-frequency DualBeam PLUS or Dual Spectrum) to create detailed depth maps of your favorite waters.

Map Source: Humminbird CoastMaster, Humminbird LakeMaster or Navionics

Storage: AutoChart Live **saves** 8 hours of mapping data on your fish finder. After 8 hours of data has been collected, you can erase the data and continue mapping, or you can purchase a ZeroLine Map Card for unlimited mapping.

ZeroLine Map Card: To purchase a ZeroLine Map Card and download the accessory guide, visit our Web site at **humminbird.johnsonoutdoors.com**.

More Information: Visit our Web site for informational videos.

PLAN YOUR MAP

Before getting started, consider the areas where you want to create a map. Review the following tips to help you plan your map:

General Tips

- Start with your favorite fishing hot spots. It is not recommended to record survey data of an entire lake, as it will require a lot of time to map and might include areas you don't want.
- Take a different route to and from each fishing spot every trip. You may discover new and interesting areas to map.
- Start a new track or recording when you start for the day. Record new data every trip to create new maps or improve existing maps.
- Navigate the boat at a consistent speed when recording data.
- See the illustration below for instruction on how to navigate your boat while recording survey data.

Mapping a Specific Area or Object in Detail

- Navigate the boat across the area rather than alongside.
- Turn the boat where the area and/or object is out of range of the transducer beam[s].
- Try to reduce the measurement time, so as to reduce the error due to possible GPS variations.

Mapping an Entire Lake

- Follow a plan.
- Follow the maximum gradient of the sea floor (up or down).
- Keep a steady speed. Trolling speeds to low speeds are recommended.
- Turn the boat where the bottom is flat if possible.

Navigating the Boat to Record Survey Data

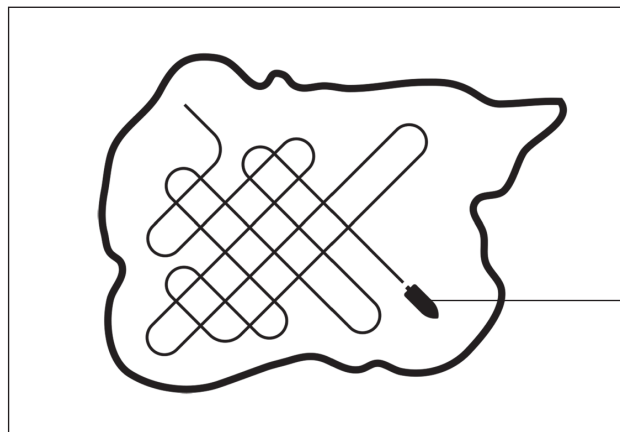

Navigate your boat in a zig-zag pattern, first in one direction and then in the other.

1. PREPARE THE FISH FINDER FOR MAPPING

When you start your mapping for the day, it is important to note if the water level is higher or lower than usual. It is also important to use your 2D transducer beams exclusively.

1 | Set the Map Source

AutoChart LIVE can be used when Humminbird CoastMaster, Humminbird LakeMaster or Navionics is set as the map source. When you install a map card, the map source is changed automatically to match the SD card map source. If your fish finder has two cards installed, you can choose which map source you want to use. You can also change the map source using the Settings tool.

1. With a Chart View displayed on-screen, tap the Menu icon in the Top Bar, or press the MENU key once.
2. Select Settings.
3. Select Chart Source.
4. Select Humminbird or Navionics.

2 | Confirm the 2D Transducer and Turn off Additional Transducers

To record your custom map, you must have a reliable and accurate digital depth from a pinging 2D transducer. You can use your Humminbird CHIRP transducer with 2D (down beam) capabilities, DualBeam PLUS transducer (83/200 kHz or 50/200 kHz), or the Side Imaging transducer with 2D (down beam) capabilities.

When you are recording your map, you should have only one 2D transducer pinging on your boat. If you have other 2D transducers pinging on remote fish finders, you should turn them off. Down Imaging and Side Imaging beams can operate at the same time. You do not need to turn them off.

1. Press the HOME key.
2. Select Settings.
3. Select Sonar.
4. Select Sonar Source.
5. Select the 2D Sonar tab.
6. Confirm that 2D Pinging is turned on. Tap the **2D Pinging** on/off button, or press the ENTER key, to turn it **on**.

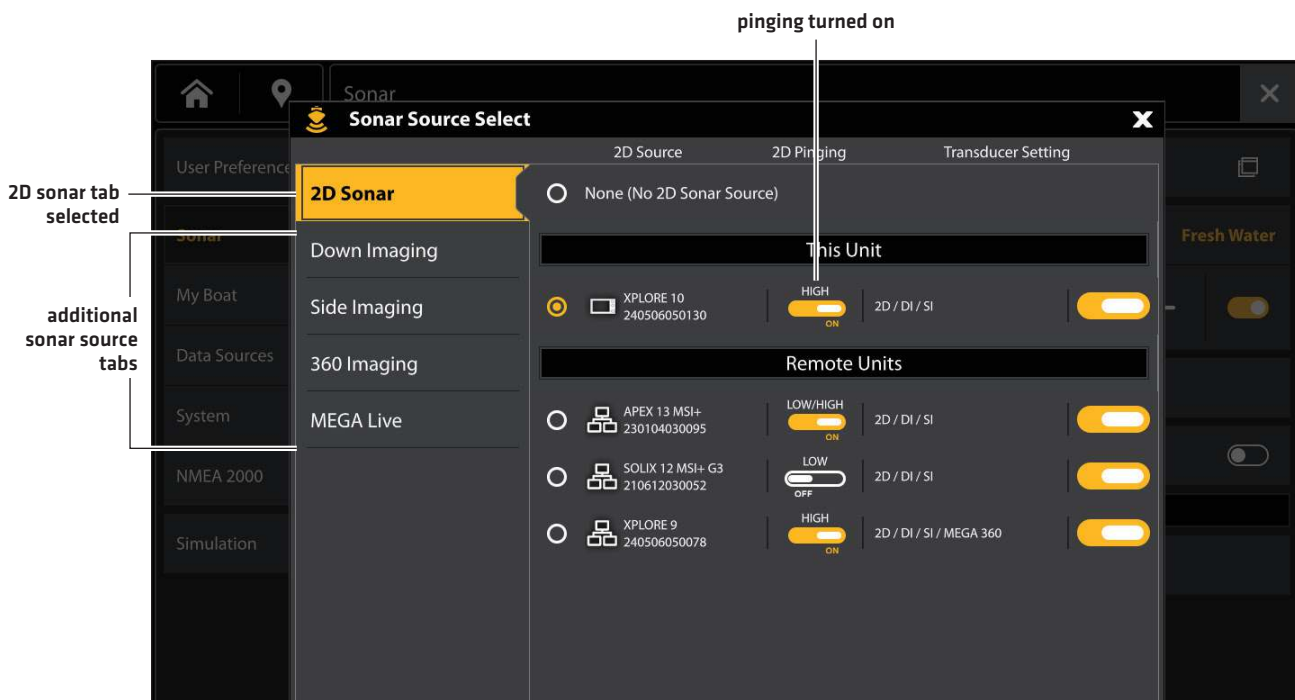

NOTE

For more information about the Sonar Source Select dialog box, see *Set up your Humminbird Network: Select Sonar Sources*.

7. Press and hold the EXIT key to close the menu system.
8. If there are additional fish finders on your boat with a 2D transducer, confirm that they are not pinging while you are mapping. There should be only one 2D transducer pinging on your boat during the recording process.

3 | Confirm Digital Depth and GPS Fix

1. Press the HOME key.
2. Select a Chart View from the Views or Favorites menu.
3. **Confirm Digital Depth:** Confirm the depth digital readout is displayed. It may take a moment for depth to be displayed.
4. **Confirm GPS Fix:** Confirm the speed digital readout is displayed. See *Getting Started: Check Sensor Reception and Connections* for more information.

digital depth missing

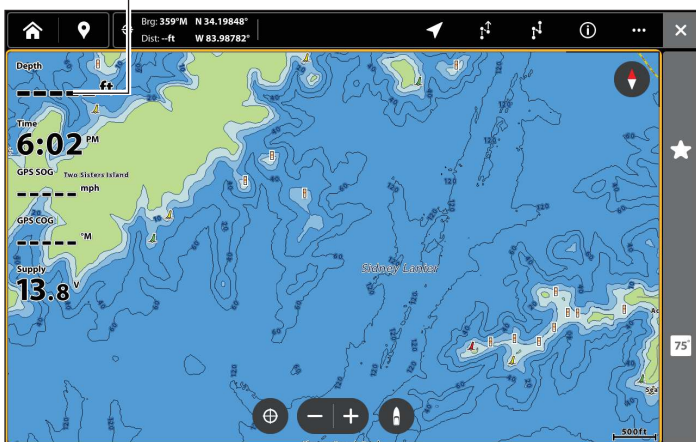

digital depth detected speed

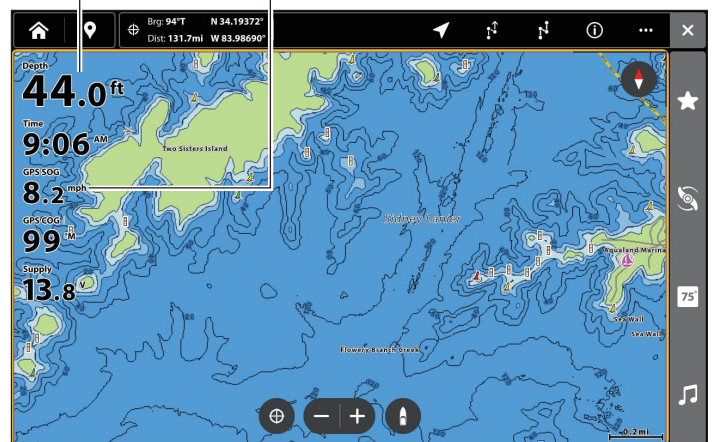

4 | Adjust the Water Level Offset

When you start your mapping for the day, it is important to note if the water level is higher or lower than usual. For example, if you know the lake is down 3 feet, set the Water Level Offset to -3.

1. With a Chart View displayed on-screen, tap the Menu icon in the Top Bar, or press the MENU key once.
2. Select Water Level Offset.
Tap the on/off button, or press the ENTER key, to turn it on.
3. Tap the +/- icons, or press the +/- ZOOM keys, to adjust the setting.

If the water level is higher than normal, set a positive amount.

If the water level is lower than normal, set a negative amount.

If the water level has not changed [normal], turn off Water Level Offset.

5 | Display the Current Track (optional)

It is helpful to display the current track so you can see where the boat has already traveled while you're recording the map.

1. With a Chart View displayed on-screen, tap the Menu icon in the Top Bar, or press the MENU key once.
2. Select Settings.
3. Select Overlays > Nav Data.
4. Tap the Nav Data on/off button, or press the ENTER key, to turn it on.
5. Add a check mark to Tracks [Active].
6. Press and hold the EXIT key until the menu system is closed.

To change the track color, see **Manage your Navigation Data: Manage Tracks**.

6 | Start a Sonar Recording for AutoChart PC (optional)

If you are planning to use AutoChart PC, start a sonar recording before you start recording your custom map. Sonar Recording can be started from the Record tool or from the X-Press Menu in a Sonar View. The instructions for the Record tool are shown here.

1. Press the HOME key.
2. Select Tools.
3. Select the Record tool.
4. Select Record, and set up the sonar recording:
 - Select Recording Sources, and select the beams to be recorded.
 - Select Save Location, and select an installed SD card.
5. Select Start Recording.

NOTE

For more information, see **Sonar Recording**. Also, visit our Web site at humminbird.johnsonoutdoors.com to purchase AutoChart PC and download the manual.

2. RECORD YOUR CUSTOM MAP

While recording your custom map, Chart View will display the depth contour data in real time. Bottom hardness and vegetation will be recording at the same time, however, the data is not displayed in real time on the Chart View.

1. **Preparation:** Before you start mapping for the day, confirm that the fish finder is set up as shown in the section *Prepare the Fish Finder for Mapping*.
2. With a Chart View displayed on-screen, tap the Menu icon in the Top Bar, or press the MENU key once.
3. Select AutoChart LIVE.
4. Select Record.
5. Tap the on/off button, or press the ENTER key, to turn it on.

Display: Select AutoChart LIVE. Tap the check box, or press the ENTER key, to add a check mark to it.

Navigate your boat in a zig-zag pattern, first in one direction and then in the other. Maintain a consistent low speed to trolling speed while you map. See *Plan your Map* for details.

Starting an AutoChart LIVE Recording

The screenshot displays the AutoChart LIVE interface. On the left, a depth contour map is shown with a yellow line representing the current track and black lines representing depth contours. The map includes a depth scale at the bottom ranging from 0ft to 50ft. On the right, the AutoChart™ Live settings menu is open, showing various options and their status.

Map Data:

- Depth: 42.0 ft
- Time: 9:45 AM
- GPS SOG: 8.4 mph
- GPS COG: 108°
- Supply: 13.8 V

AutoChart™ Live Settings:

- Record: (turn on Record)
- AutoChart™ Live: (add a check mark to display the depth map on the Chart View)
- 100 % (depth map in progress)
- AC Live Options
- Show Raw Data
- Hardness Layer: (boat icon)
- Bottom Hardness: (heading line)
- Vegetation:
- Hardness Options
- Save Location

Map Labels:

- current track (yellow line)
- contour line(s) (black lines)
- depth map scale

Collecting Data for your AutoChart LIVE Map

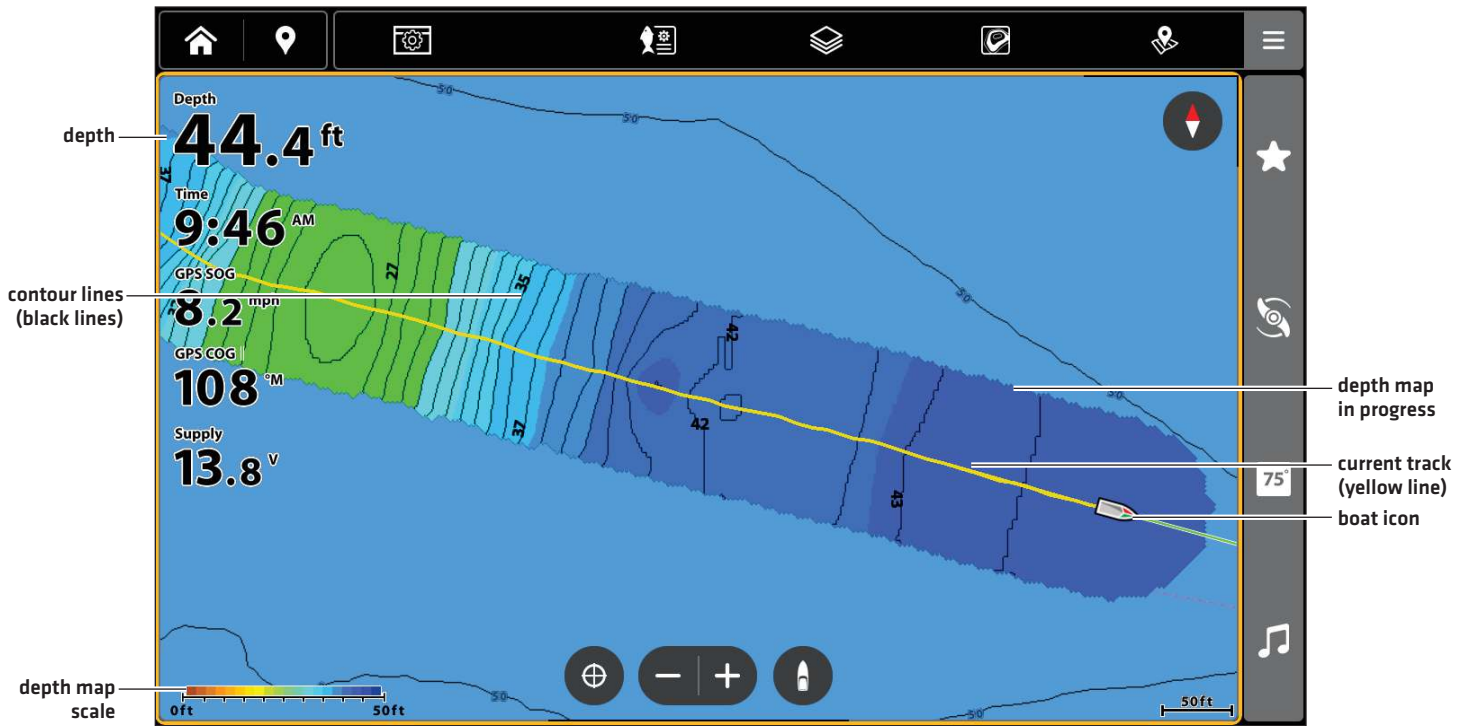

3. STOP RECORDING

Use the instructions in this section to stop recording. Your map is automatically saved to the fish finder [internal] or to the ZeroLine Map Card if it is installed.

1. With a Chart View displayed on-screen, tap the Menu icon in the Top Bar, or press the MENU key once.
2. Select AutoChart LIVE.
3. Select Record. Tap the on/off button, or press the ENTER key, to turn it off.

If you do not have a Zero Line Map Card installed, and the fish finder storage [8 hours] is reached, the fish finder will provide a dialog box to Confirm or Clear Data. To save your map and turn off recording, select Confirm. To erase your map and start over, select Clear Data.

DISPLAY THE AUTOCHART LIVE MAP

You can make changes to the AutoChart Live map during recording or after you've saved your map. You can also view bottom hardness or vegetation data, and you can customize how the data is displayed.

Display/Hide your Custom Map

The custom map can be displayed or hidden while you are recording or after the map is saved. You can also adjust the transparency.

Display the Map

1. With a Chart View displayed on-screen, tap the Menu icon in the Top Bar, or press the MENU key once.
2. Select AutoChart LIVE.
3. Select AutoChart LIVE. Tap the check box, or press the ENTER key, to add a check mark to it.

Adjust the Transparency

1. Tap the +/- icons, or press the +/- ZOOM keys, to adjust the transparency.

Adjusting the Overlay Transparency

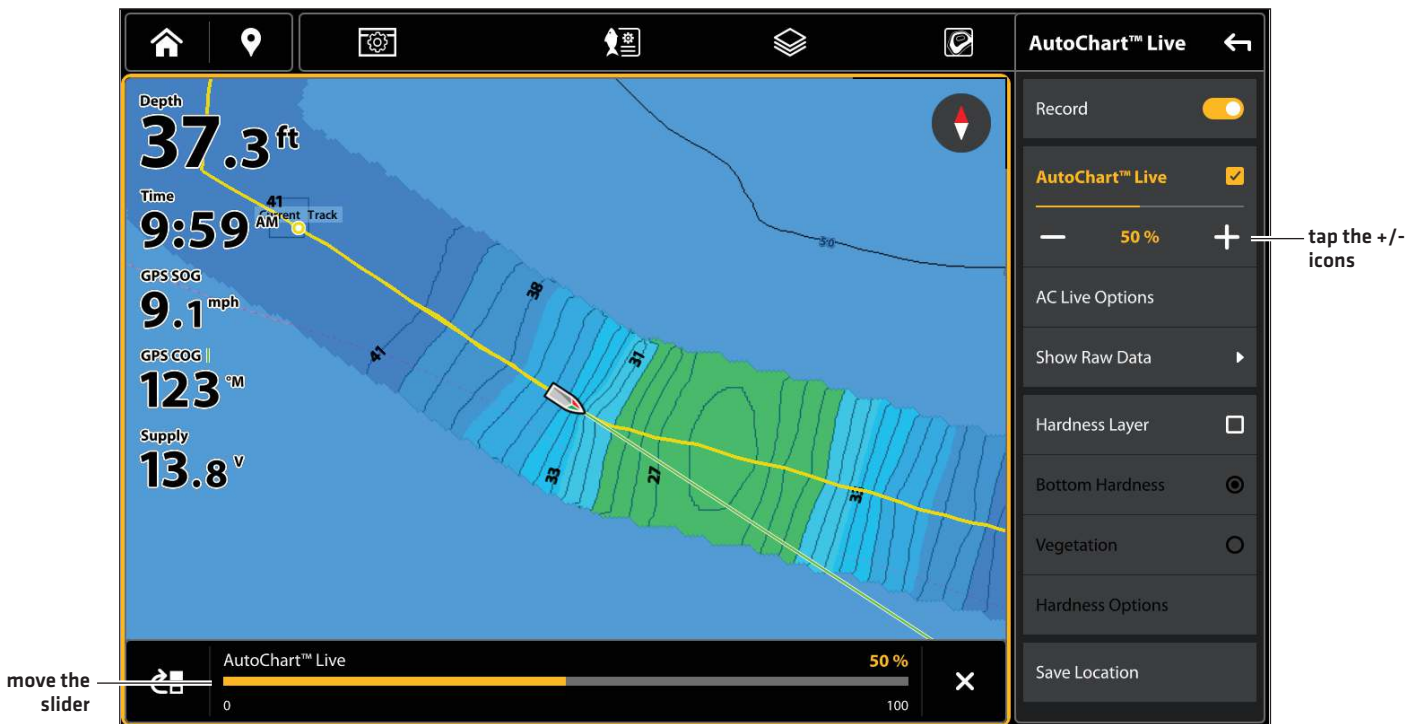

Hide the Map

1. With a Chart View displayed on-screen, tap the Menu icon in the Top Bar, or press the MENU key once.
2. Select AutoChart LIVE.
3. Select AutoChart LIVE. Tap the check box, or press the ENTER key, to remove the check mark.

Display the AC Live Color Bar

The AC Live Color bar allows you to display the palette icon for AutoChart Live or Bottom Type. You can use this icon to see the selected palette and, from left to right, the AutoChart Live depth range [low to high], Bottom Hardness range [soft to hard], or Vegetation range [soft to hard].

Show/Hide the AC Live Color Bar (VX Charts)

1. With a Chart View displayed on-screen, tap the Menu icon in the Top Bar, or press the MENU key once.
2. Select Settings.
3. Select General.
4. Select Color Bar.
5. Select Color Bar. Tap, or press the ENTER key, to turn it on.
6. Select a display bar.

Show/Hide the AC Live Color Bar (Legacy Charts)

1. With a Chart View displayed on-screen, tap the Menu icon in the Top Bar, or press the MENU key once.
2. Select Settings.
3. Select Overlays.
4. Select AC Live Color Bar.
5. Select Color Bar. Tap, or press the ENTER key, to turn it on.
6. Select a display bar.

Display AutoChart Live and Bottom Layer in Chart/Chart Combo View

You can also use the Chart/Chart Combo View to display AutoChart Live and Bottom Layer data at the same time. Use the X-Press Menu to make adjustments to each pane.

Display AutoChart Live and Bottom Layer Data in the Chart/Chart Combo View

1. Press the HOME key.
2. Open the Views menu.
3. Select a Chart/Chart Combo View.
4. With the Chart/Chart Combo View displayed on-screen, select a pane.
5. Tap the Menu icon in the Top Bar, or press the MENU key once.
6. Select AutoChart Live.
7. Select Vegetation Layer or Hardness Layer. Tap the check box, or press the ENTER key, to add a check mark to it.
8. **Adjust the Transparency:** Press and hold the slider, or turn the Rotary dial, to adjust the transparency.
9. **Close:** Press the EXIT key until the menu is closed.
10. **Repeat:** Repeat steps 4 through 6.
11. Select AutoChart Live. Tap the check box, or press the ENTER key, to add a check mark to it.
12. **Adjust the Transparency:** Press and hold the slider, or turn the Rotary dial, to adjust the transparency.

Displaying AutoChart Live and Bottom Layer in Chart/Chart Combo View

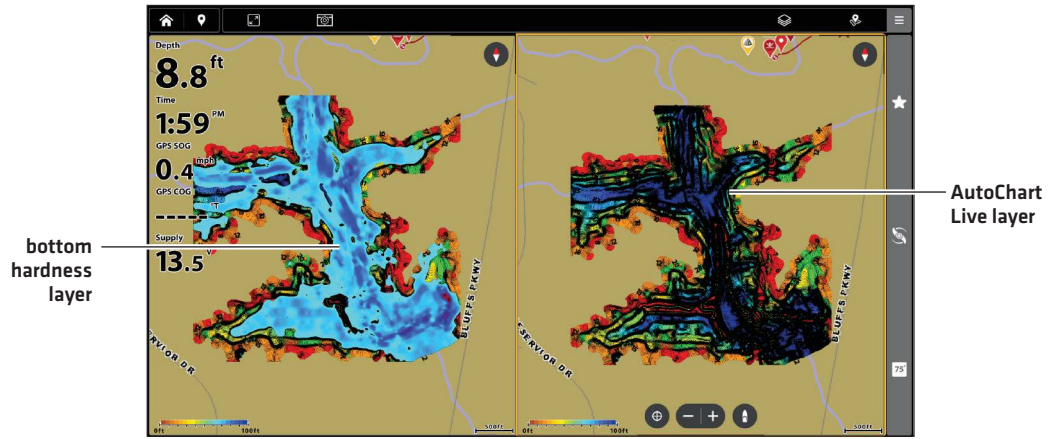

Display Raw or Map Data

Select Show Map Data to display contour lines and depth data. Select Show Raw Data to display individual data points.

1. From the AutoChart Live menu, select Show Raw Data or Show Map Data.
2. Press the ENTER key.

ADJUST THE MAP DISPLAY SETTINGS

Use the AutoChart Live Options menu to adjust the depth range, contour interval, and map position. You can also change the color palette and shading.

Some of the menu options in this section may be displayed in other parts of the menu system so that you can access them quickly. No matter where you make the change, the fish finder will update the setting across the system.

Open the AutoChart Live Options Menu

You will use the AutoChart Live Options menu for all display settings.

1. With a Chart View displayed on-screen, tap the Menu icon in the Top Bar, or press the MENU key once.
2. Select AutoChart LIVE.
3. Select AC Live Options.

Adjust the Depth Range

You can adjust the range of data shown on the chart by changing the minimum range and maximum range on the display. The range you select affects how the depth colors are displayed. For best results, set a narrow depth range threshold. For example, set the Min Range to 10 and the Max Range to 30. For related color or shading options, see *Add Settings with Chart Options*.

1. From the AC Live Options menu, select Min Range.
2. Tap the +/- icons, or press the +/- ZOOM keys, to adjust the setting.
3. Select Max Range.
4. Tap the +/- icons, or press the +/- ZOOM keys, to adjust the setting.

Adjusting the Display Depth Range

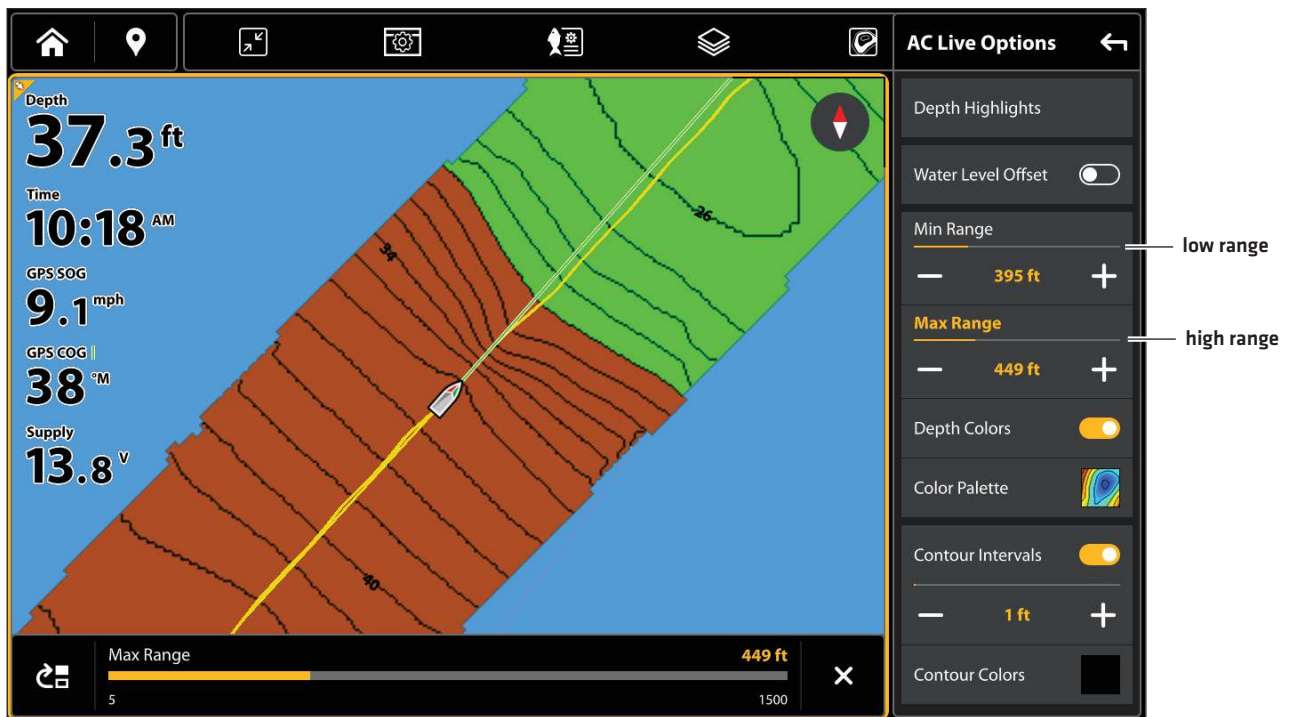

Change the Display Colors

Use the following instructions to change the color palette used to display the AutoChart Live map.

Changing the AutoChart Live Color Palette

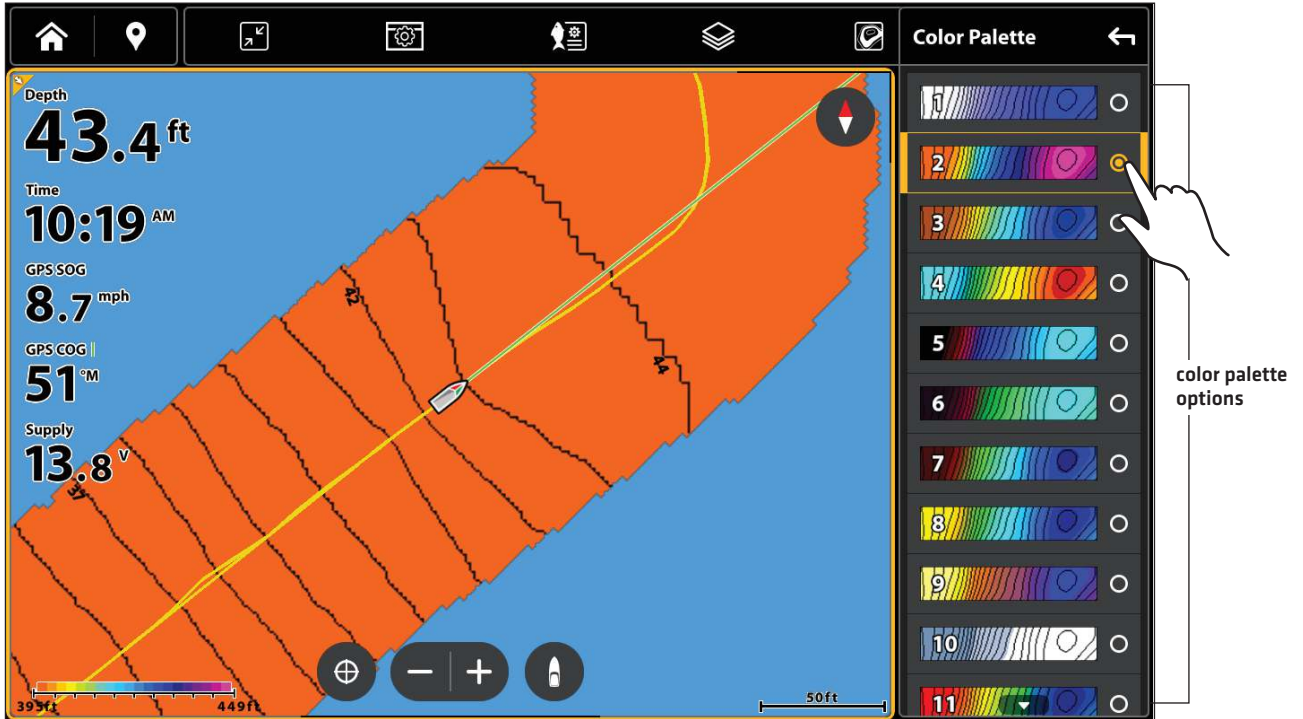

Change the Color Palette

The Color Palette menu changes the colors used to display the AutoChart Live map. The color range is shown in the AC Live Color bar and is affected by the Min Range and Max Range settings. See [Adjust the Depth Range](#) for more information.

1. From the AutoChart Live Options menu, select Color Palette.
2. Select a palette.

Show/Hide Depth Colors

Use the following instructions to show or hide the depth colors. If you hide the depth colors, the contours will be shown on the display.

1. From the AutoChart Live Options menu, select Depth Colors.
2. Tap the on/off button, or press the ENTER key, to turn it On [visible] or Off [hidden].

Change the Highlight Color

If you've set the Depth Highlight and Depth Highlight Range in the Humminbird Settings menu [Chart X-Press Menu > Settings], and it is not easy to see with the AutoChart Live color palette you've selected, you can change the Highlight Color. See [Customize the Chart View](#) for more information.

1. From the AutoChart Live Options menu, select Depth Highlights.
2. Select a color for the depth highlight.

Change the Shallow Color

If you've set the Shallow Water Highlight in the Humminbird Settings menu [Chart X-Press Menu > Settings], and it is not easy to see with the AutoChart Live color palette you've selected, you can change the Shallow Color. See *Customize the Chart View* for more information.

1. From the AutoChart Live Options menu, select Depth Highlights.
2. Select a color for the shallow water highlight.

Display or Adjust the Contour Interval

You can display or hide the contour lines on the map, and you can adjust the slider to set the distance between each contour line. Contour Interval is also affected by the Water Level Offset setting.

Display the Contour Lines and Adjust the Contour Interval

1. From the AutoChart Live Options menu, select Contour Intervals.
2. Tap the on/off button, or press the ENTER key, to turn it on.
3. Tap the +/- icons, or press the +/- ZOOM keys, to adjust the setting.

Change the Contour Lines Color

1. From the AutoChart Live Options menu, select Contour Colors.
2. Select a color.

Adjusting the Contour Interval

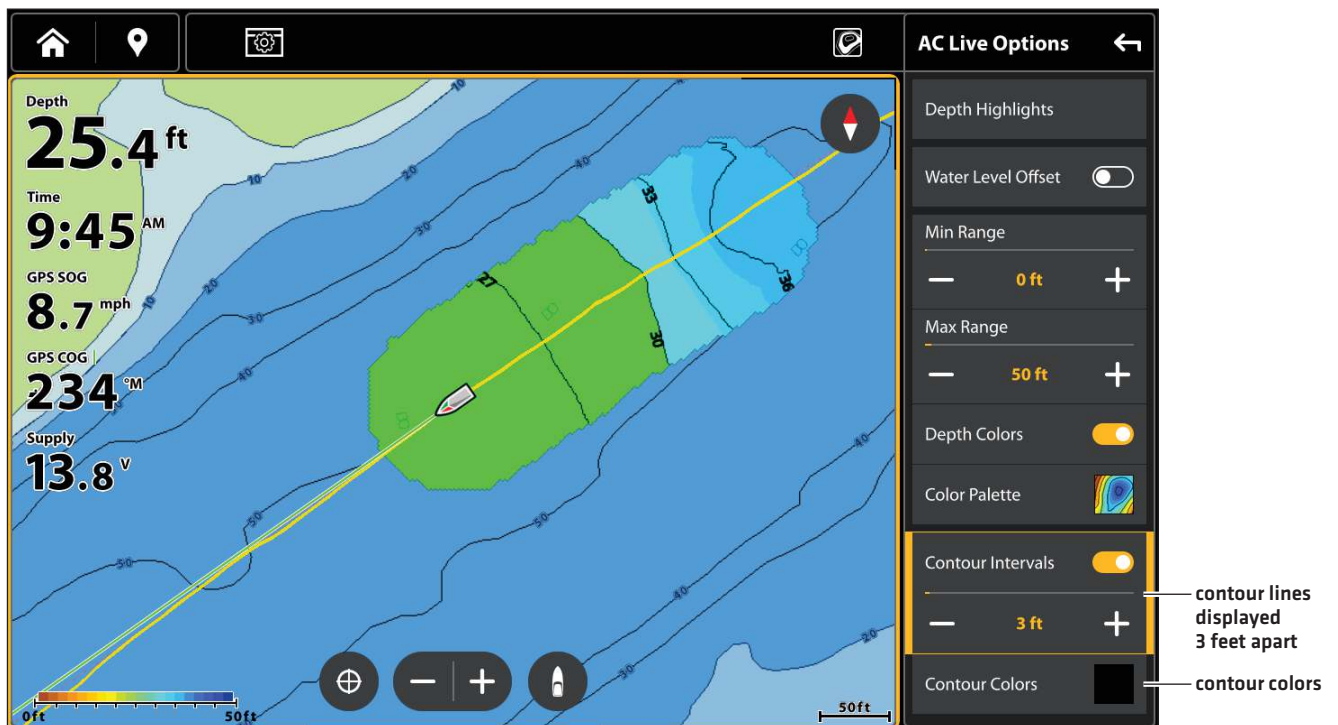

Change the Water Level Offset

When you start your mapping for the day, it is important to note if the water level is higher or lower than usual. See *Prepare the Fish Finder for Mapping* for more information.

1. From the AutoChart Live Options menu, select Water Level Offset.
2. Tap the on/off button, or press the ENTER key, to turn it on.
3. Tap the +/- icons, or press the +/- ZOOM keys, to adjust the setting.

If the water level is higher than normal, set a positive amount.

If the water level is lower than normal, set a negative amount.

If the water level has not changed [normal], turn off Water Level Offset.

Add Humminbird Chart Settings

If Humminbird is set as the map source, you can add Depth Colors, Shallow Water, etc. to your AutoChart LIVE map. See *Customize the Chart View: Adjust the Depth Range and Colors* for more information.

Adding Shallow Water Settings to the Map (Map Source: Humminbird)

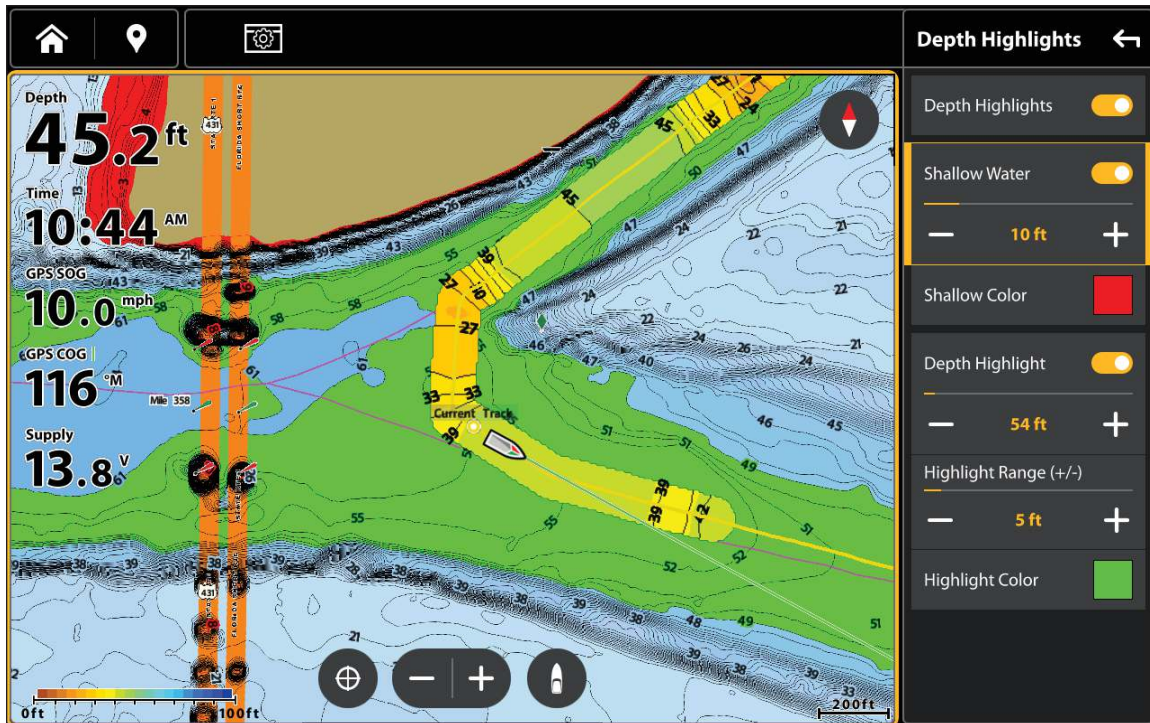

Add Navionics Settings with Chart Options

If Navionics is set as the map source, you can display Contours and Shading on your AutoChart LIVE map. See *Customize the Chart View: Select Map Data* for more information.

CUSTOMIZE THE BOTTOM HARDNESS DISPLAY SETTINGS

The bottom layer is displayed on top of the AutoChart Live map and can be displayed as bottom hardness or vegetation. Bottom Hardness shows strong sonar returns resulting from compacted sediment, rocks, fallen trees, etc.

Show/Hide Bottom Hardness

The bottom layer is displayed on top of the AutoChart Live map, and you can adjust the transparency to see different layers on the view. Both bottom hardness and bottom vegetation cannot be displayed at the same time in Chart View.

Show Bottom Hardness

1. From the AutoChart Live menu, select Hardness Layer or Vegetation Layer. Tap, or press the ENTER key, to add a check mark to the box.
2. Select Bottom Hardness.
3. **Adjust the Transparency:** Tap the +/- icons, or press the +/- ZOOM keys, to adjust the setting.

Displaying the Bottom Hardness Layer (Map Source: Humminbird)

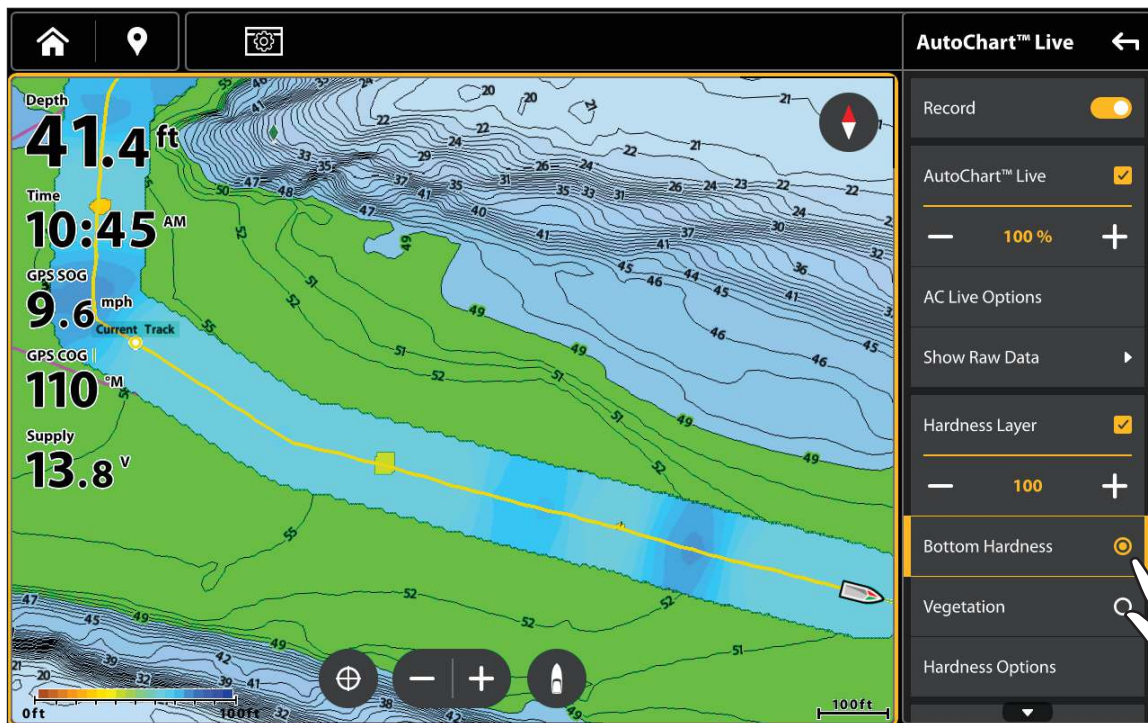

Hide Bottom Hardness

1. From the AutoChart Live menu, select Hardness Layer. Tap, or press the ENTER key, to remove the check mark from the box.

Adjust the Gain Offset

Use Gain Offset to tune the bottom hardness display. For example, if you're fishing a lake where most of the lake has a hard bottom, reduce the gain so only the hardest bottom is displayed.

1. From the AutoChart Live menu, select Hardness Options.
2. Select Gain Offset.
3. Tap the +/- icons, or press the +/- ZOOM keys, to adjust the setting.

Adjust the Hardness Range

You can adjust the range of bottom hardness shown on the chart by changing the minimum range and maximum range on the display. The range you select affects how the bottom hardness colors are displayed. The range is displayed in the AC Live Color Bar with Bottom Hardness selected.

1. From the AutoChart Live menu, select Hardness Options.
2. Select Min Hardness. Tap the +/- icons, or press the +/- ZOOM keys, to adjust the setting.
3. Select Max Hardness. Tap the +/- icons, or press the +/- ZOOM keys, to adjust the setting.

Adjusting the Bottom Hardness Range (Map Source: Humminbird)

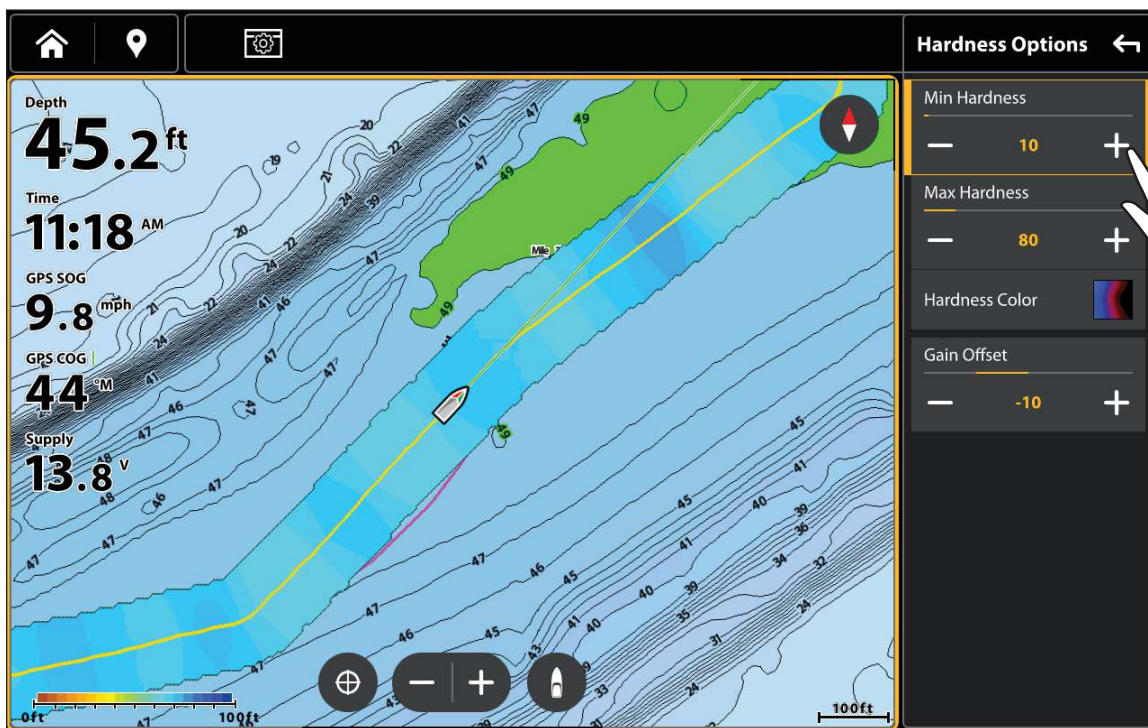

NOTE

Use the AC Live Color Bar icon see the selected palette and, from left to right, the AutoChart Live depth range [low to high], Bottom Hardness range [soft to hard], or Vegetation range [soft to hard].

Change the Bottom Hardness Colors

Use the following instructions to change the color palette used to display Bottom Hardness.

Change the Hardness Colors

The Hardness Color menu changes the colors used to display bottom hardness on the view. The color range is shown in the AC Live Color bar and is affected by the Min Hardness and Max Hardness settings. See **Adjust the Hardness Range** for more information.

1. From the AutoChart Live menu, select Hardness Options.
2. Select Hardness Color.
3. Select a palette.

Changing the Bottom Hardness Colors
[Map Source: Humminbird]

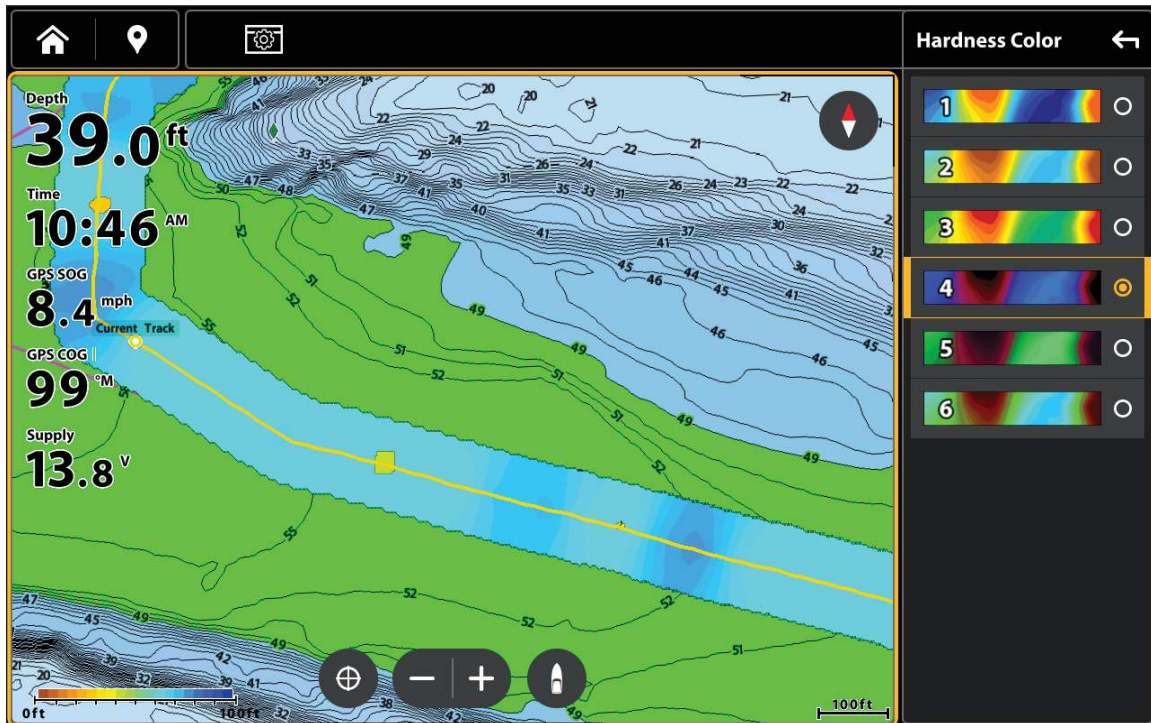

CUSTOMIZE THE VEGETATION DISPLAY SETTINGS

The Bottom Layer is displayed on top of the AutoChart Live map and can be displayed as bottom hardness or vegetation. Vegetation shows the sonar returns interpreted as vegetation on the Chart View. Both bottom hardness and bottom vegetation cannot be displayed at the same time in Chart View.

Show/Hide Vegetation

Show Vegetation

1. From the AutoChart Live menu, select Hardness Layer or Vegetation Layer. Tap, or press the ENTER key, to add a check mark to the box.
2. Select Vegetation.
3. **Adjust the Transparency:** Tap the +/- icons, or press the +/- ZOOM keys, to adjust the setting.

Displaying the Vegetation Layer [Map Source: Humminbird]



Hide Vegetation

1. From the AutoChart Live menu, select Vegetation Layer. Tap, or press the ENTER key, to remove the check mark from the box.

Adjust the Gain Offset

Use Gain Offset to tune the vegetation display. Vegetation will vary with the lake, season, or environment you are fishing, and you should adjust the Gain Offset as needed.

1. From the AutoChart Live menu, select Vegetation Options.
2. Select Gain Offset.
3. Tap the +/- icons, or press the +/- ZOOM keys, to adjust the setting.

Adjust the Vegetation Range

You can adjust the range of vegetation shown on the chart by changing the minimum range and maximum range on the display. The range you select affects how the vegetation colors are displayed.

1. From the AutoChart Live menu, select Vegetation Options.
2. Select Min Vegetation. Tap the +/- icons, or press the +/- ZOOM keys, to adjust the setting.
3. Select Max Vegetation. Tap the +/- icons, or press the +/- ZOOM keys, to adjust the setting.

Adjusting the Vegetation Hardness Range (Map Source: Humminbird)

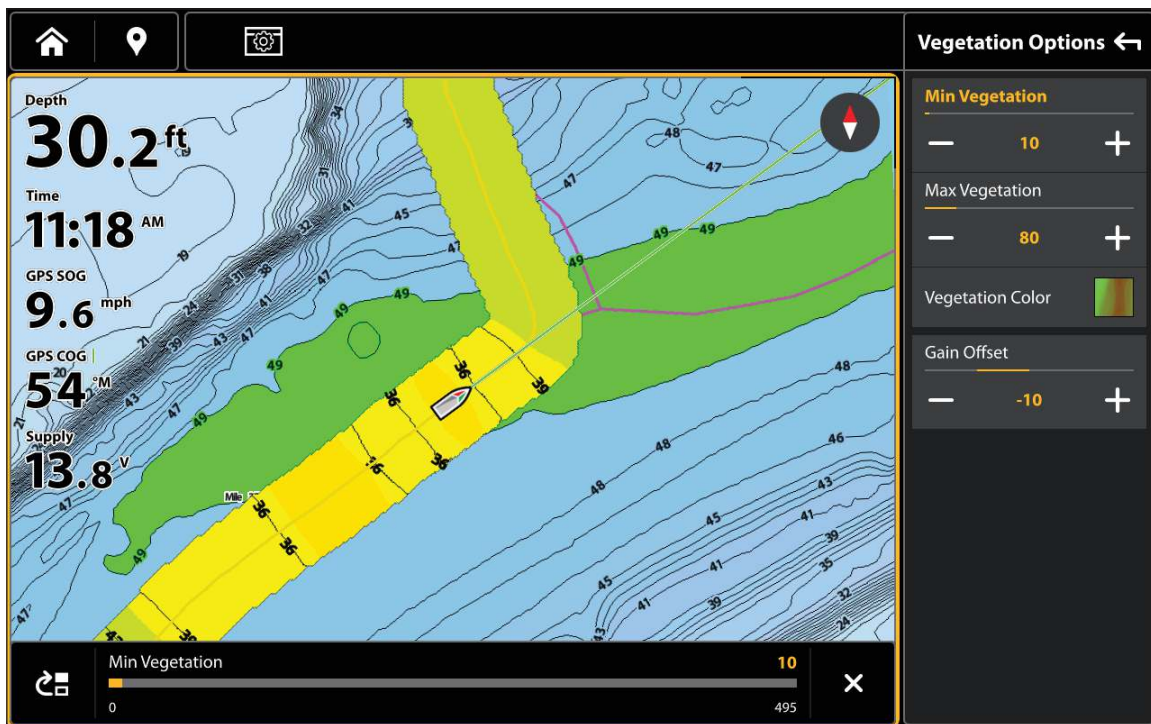

NOTE

Use the AC Live Color Bar icon to see the selected palette and, from left to right, the AutoChart Live depth range [low to high], Bottom Hardness range [soft to hard], or Vegetation range [soft to hard].

Change the Vegetation Colors

The Vegetation Color menu changes the colors used to display vegetation on the view. The color range is shown in the AC Live Color Bar and is affected by the Min Vegetation and Max Vegetation settings. See [Adjust the Vegetation Range](#) for more information.

1. From the AutoChart Live menu, select Vegetation Options.
2. Select Vegetation Color.
3. Select a palette.

Changing the Vegetation Colors (Map Source: Humminbird)



NOTE

Use the AC Live Color Bar icon see the selected palette and, from left to right, the AutoChart Live depth range [low to high], Bottom Hardness range [soft to hard], or Vegetation range [soft to hard].

SONAR OVERVIEW

A functioning transducer must be attached to the fish finder or selected as the transducer source on the Ethernet network to enable sonar functions. To purchase transducers, visit our Web site at humminbird.johnsonoutdoors.com.

The XPLORE, APEX and SOLIX fish finders support the following sonar:

- MEGA Imaging+ with Dual Spectrum CHIRP Sonar
- MEGA Imaging with Dual Spectrum CHIRP Sonar
- Dual Spectrum CHIRP Sonar (2D)
- **Digital CHIRP Sonar:** 2D CHIRP, Side Imaging CHIRP and Down Imaging CHIRP use multiple frequency ranges, either individually or blended together.

NOTE

Depth capability is affected by such factors as boat speed, wave action, bottom hardness, water conditions, and transducer installation. See the **Specifications** section for details.

MEGA Imaging+

MEGA Side Imaging+ and MEGA Down Imaging+ sonar provides two high frequency options, and includes [2D] Dual Spectrum CHIRP sonar.

MEGA Imaging+ transducers

MEGA SI+

XM 14 HW MSI T
 XPTH 14 HW MSI T
 XM 14 HW CMSI T
 XPTH 14 74 MSI T
 SSTH 14 HW MSI T
 Built-in MSI+

MEGA DI+

XM 14 HW MDI T
 XTM 14 HW MDI T
 Built-in MDI+

MEGA SI+

MSI+ sonar uses two very precise sonar beams that are aimed at right angles to the path of the boat. The side beam coverage is very thin from front to back, yet very wide from top to bottom. The beams provide thin slices of the bottom for high resolution imaging. The beams can be operated at one of two display frequencies: MEGA+ or 455 kHz.

MSI+ sonar also provides MEGA Down Imaging+ and [2D] Dual Spectrum CHIRP sonar.

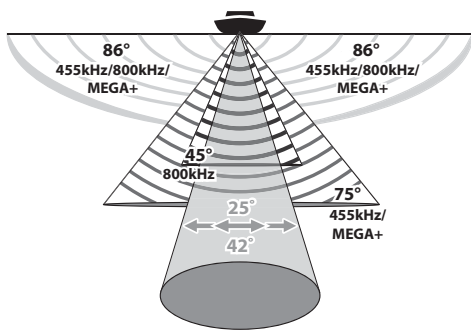

MEGA SI+ Cone Angles

MEGA+

Select MEGA for the highest resolution, sharpness, and range (up to 500 ft side to side).

455 kHz

Select 455 kHz for deep water and overall coverage (up to 800 ft side to side).

MEGA DI+

MDI+ sonar beams point down and scan the water with razor-thin, high definition beams that are wide side to side, but very thin from front to back. The beams can be operated at one of two display frequencies: MEGA+ or 455 kHz.

MDI+ also includes [2D] Dual Spectrum CHIRP sonar.

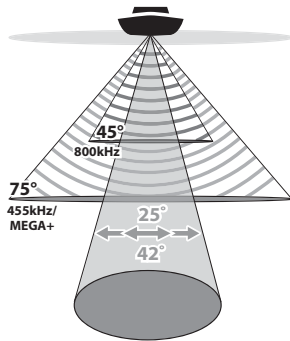

MEGA DI+ Cone Angles

MEGA+

Select MEGA for the highest resolution, sharpness, and depth (up to 250 ft).

455 kHz

Select 455 kHz for deep water and overall coverage (up to 400 ft).

(2D) Dual Spectrum CHIRP

Dual Spectrum CHIRP sonar provides conical coverage directly below the boat. The beam can be adjusted to show the full, narrow, or wide frequency range. The sonar returns are displayed on the Sonar [2D] Views.

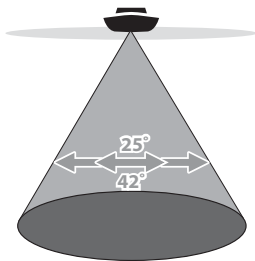

Dual Spectrum Cone Angles

Full

Select Full Beam (default) to use the complete frequency range.

Narrow

Select Narrow Beam for increased bottom detail and better target separation.

Wide

Select Wide Beam to maximize coverage and show big, clearly defined fish arches.

MEGA Imaging

MEGA Side Imaging and MEGA Down Imaging transducers provide high frequency options, and includes either [2D] Dual Spectrum CHIRP sonar or [2D] DualBeam PLUS sonar (see each table below for respective transducer models).

MEGA Down Imaging Transducers with (2D) Dual Spectrum CHIRP

XM 14 20 MDI T
XTM 14 20 MDI T

MEGA Imaging Transducers with (2D) DualBeam PLUS

MEGA SI

XM 14 20 MSI T
XPTH 14 20 MSI T
XM 14 74 MSI T

MEGA DI

XM 14 MDI T
XTM 14 20 MDI T

MEGA SI

MSI sonar uses two very precise sonar beams that are aimed at right angles to the path of the boat. The side beam coverage is very thin from front to back, yet very wide from top to bottom. The beams provide thin slices of the bottom for high resolution imaging. The beams can be operated at one of three display frequencies: MEGA, 800 kHz, or 455 kHz.

MSI sonar also provides MEGA Down Imaging and [2D] DualBeam PLUS sonar.

<p>MEGA SI Cone Angles</p>	MEGA	Select MEGA for the highest resolution, sharpness, and range (up to 250 ft side to side).
	800 kHz	Select 800 kHz as an alternative frequency with sharp returns (up to 250 ft side to side).
	455 kHz	Select 455 kHz for deep water and overall coverage (up to 800 ft side to side).

MEGA DI

MDI sonar beams point down and scan the water with razor-thin, high definition beams that are wide side to side, but very thin from front to back. The beams can be operated at MEGA, 800 kHz, or 455 kHz.

MDI sonar also provides [2D] Dual Spectrum CHIRP sonar.

<p>MEGA DI Cone Angles</p>	MEGA	Select MEGA for the highest resolution, sharpness, and depth (up to 125 ft). *For MEGA SI models, the depth is up to 75 ft.
	800 kHz	Select 800 kHz as an alternative frequency with sharp returns (up to 125 ft).
	455 kHz	Select 455 kHz for deep water and overall coverage (up to 350 ft).

(2D) Dual Spectrum CHIRP

Dual Spectrum CHIRP sonar provides conical coverage directly below the boat. The beam can be adjusted to show the full, narrow, or wide frequency range. The sonar returns are displayed on the Sonar [2D] Views.

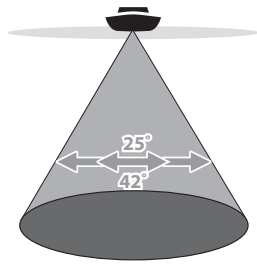

Dual Spectrum Cone Angles

Full

Select Full Beam [default] to use the complete frequency range.

Narrow

Select Narrow Beam for increased bottom detail and better target separation.

Wide

Select Wide Beam to maximize coverage and show big, clearly defined fish arches.

Dual Spectrum CHIRP

Transducers with HW Dual Spectrum CHIRP

MEGA SI+

XM 14 HW MSI T
XPTH 14 HW MSI T
XM 14 HW CMSI T
XPTH 14 74 MSI T
SSTH 14 HW MSI T
Built-in MSI+

MEGA DI+

XM 14 HW MDI T
XTM 14 HW MDI T
Built-in MDI+

MEGA DI

XM 14 20 MDI T
XTM 14 20 MDI T

(2D) Dual Spectrum CHIRP

XNT 14 HW T
XP 14 HW
XP 14 HW T
XTM 14 HW T
Built-in DSC

Traditional (2D) 83/200 kHz Sonar

DualBeam PLUS sonar provides conical coverage directly below the boat. DualBeam PLUS sonar returns are displayed in Sonar [2D] Views. The beams can be blended together, viewed separately, or compared side-to-side.

83/200 kHz Transducers

2D Sonar

XNT 14 20 T
XP 14 20 T
XP 14 20
XTM 14 20 T
XTH 14 20
XPTH 14 20 T

SI

XM 14 20 MSI T
XPTH 14 20 MSI T
XT 14 20 HDSI T
XPTH 14 20 HDSI T

DualBeam PLUS Sonar

DualBeam PLUS sonar provides conical coverage directly below the boat. The beam can be adjusted to show the medium, high, or medium-high frequency range. DualBeam PLUS sonar returns are displayed on the Sonar [2D] Views.

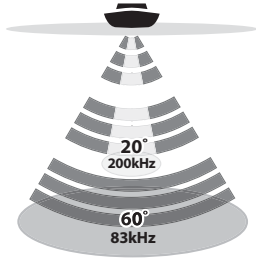

DualBeam Cone Angles

**Medium
[83 kHz]
Frequency**

Select Medium Frequency for deep water (more than 800 feet). Medium Frequency can be used for deep returns at high speed. If Medium Frequency is selected, the high frequency beam pings in the background but is not displayed.

**High
[200 kHz]
Frequency**

Select High Frequency for more detail at shallower depths (less than 800 feet). If High Frequency is selected, the medium frequency beam is not available.

**Medium/
High
[83/200 kHz]
Frequency**

Select Medium/High Frequency to ensure both beams ping continuously, so the sonar history is not interrupted if the Sonar View is closed.

The returns from both beams are blended by starting with the wide beam return, dimming it, and then overlaying it with the narrow beam return. The narrow beam sonar returns will stand out from the wide beam sonar returns.

Digital 50/200 kHz CHIRP Sonar

50/200 kHz Transducers

2D Models

XNT 14 74 T
XP 14 74 T
XP 14 74
XTM 14 74 T
XTH 14 74
XPTH 14 74 T

DI Models

XPTH 14 74 DI T

SI Models

XPTH 14 74 MSI T
XM 14 74 MSI T
XT 14 74 HDSI T
XPTH 14 74 HDSI T

2D Display

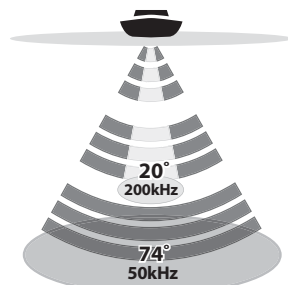

50/200 kHz Cone Angle

**50 kHz
[Low]**

Select 50 kHz for deep water (more than 1500 feet). 50 kHz can be used for deep returns at high speed. If 50 kHz is selected, the 200 kHz beam pings in the background but is not displayed.

**200 kHz
[High]**

Select 200 kHz for faster pinging and shallower water (less than 800 feet).

SONAR SETUP

The available sonar views and menus on the fish finder are determined by the connected transducer and the selected transducer source. The selected transducer must be pinging to enable the views.

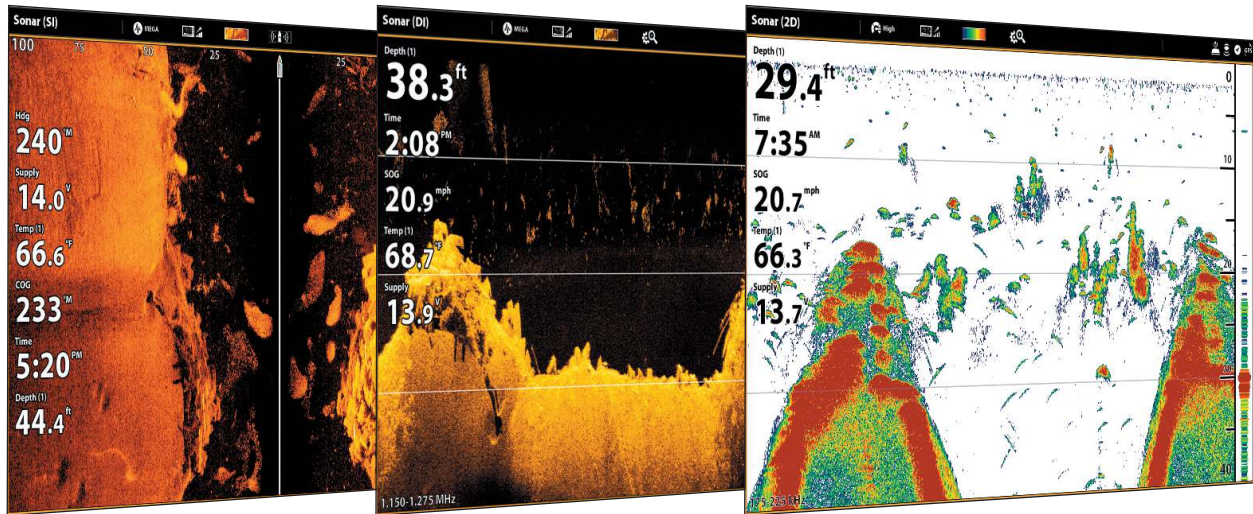

When you connect a transducer to an XPLORE, APEX or SOLIX fish finder, the transducer will be detected in the network automatically. The best sonar source will be chosen and start pinging automatically.

To manually select a sonar source, see *Installation Information: Set up your Humminbird Network*.

Transducer Settings: To review transducer settings, including sonar frequencies, depth offset, and maximum depth, see *Installation Information: Set up or Change Transducer Settings*. Also, visit our Web site at humminbird.johnsonoutdoors.com to download the *Transducer Setup Guide* and review troubleshooting options.

Sonar Settings: You can also change the water type, adjust the noise filter, and select transducer beams. The main sonar settings are displayed in the Sonar tab in the Settings tool [Home > Settings > Sonar]. If an accessory transducer is added to the configuration [such as a 360 Imaging transducer or an Airmar CHIRP transducer], the related menu options will be added to the menu system. See *Installation Information: Set up or Change Transducer Settings*.

NOTE

Visit our Web site at humminbird.johnsonoutdoors.com for the latest compatible transducers and accessories for your fish finder.

Start Pinging from a Sonar View

When a transducer is connected to the fish finder, the Sonar View will be automatically added to the view database.

1. From the Home screen, tap the Views icon or Favorites icon in the menu tray.
2. Tap the sonar category and select your preferred view.
3. The sonar returns will begin to display on the view automatically.

Stop Pinging from a Sonar View

1. With a Sonar View displayed on the screen, tap PING ON/Off button on the Top Bar.

Ping on:

Ping off:

SONAR ALARMS

Before you start navigating and fishing with your fish finder, set up sonar alarms. A functioning transducer must be attached to the fish finder or selected as the transducer source on the network to enable all sonar functions.

Turn on Sonar Alarms

1. Press the HOME key.
2. Select the Tools menu.
3. Select Alarms.
4. Select Alarms > Sonar.
5. Select an alarm and turn it on. Tap the on/off button, or press the ENTER key, to turn it on.
6. Drag the slider, or press and hold the ENTER key, to adjust the range setting.

Fish [Shallow]	Turn on Fish [Shallow] to receive an alarm if fish are detected in shallow water. You can also adjust the shallow water range with the slider.
Fish [Deep]	Turn on Fish [Deep] to receive an alarm if fish are detected in deep water. You can also adjust the deep water range with the slider.
Shallow Water	If the bottom depth is less than the amount you set, the control head will provide an alarm.
Deep Water	If the bottom depth is more than the amount you set, the control head will provide an alarm.

2D SONAR OVERVIEW

As the boat moves, the unit charts the changes in depth on the display to create a profile of the bottom contour. The 2D Sonar View displays the sonar return intensity with different colors.

Strong returns often result from rocky or hard bottoms [compacted sediment, rocks, fallen trees], while weaker returns often result from soft bottoms [sand, mud], vegetation, and small fish.

The colors used to represent high, medium, to low intensity returns are determined by the palette you choose in the 2D Sonar Menu [see *Open the 2D Sonar Menu: Change the Sonar Color Palette*].

The fish finder displays the return intensity based on the Sonar Color and Bottom View menu settings. You can display the RTS Window [Real Time Sonar], turn on/off fish symbols [Fish ID+], change the SwitchFire mode, adjust sensitivity, and more.

2D Sonar View: Original Palette

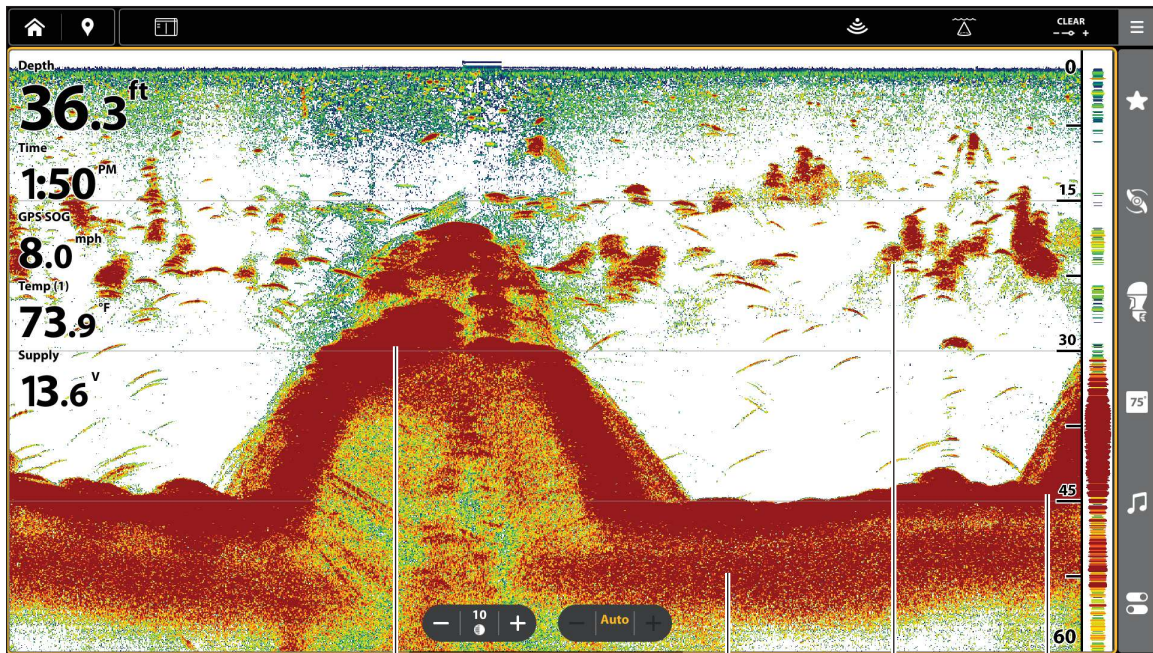

strong returns (possibly rocks, tree limbs, or other structure) medium returns weak returns (possibly vegetation or small fish) strong returns (possibly compacted sediment or rocks)



Sonar History – Historical returns scroll left across the view.



Drag to see History

OR

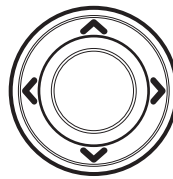

Move to see History (XPLORE)

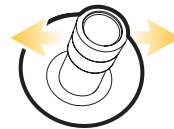

Move to see History (APEX/SOLIX)

CUSTOMIZE THE 2D SONAR VIEW

The settings in this section are optional. You can use the default settings for the 2D Sonar View, or you can customize it with your preferences. See **Views** for more information.

OPEN THE 2D SONAR X-PRESS MENU

The 2D Sonar X-Press menu allows you to set the sonar mode, zoom mode, return palette, background color, bottom view, and RTS Window. For more information about view preferences, see **Views**.

1. With a 2D Sonar View displayed on-screen, tap the Menu icon in the Top Bar, or press the MENU key once.
2. Select a display option or select Settings.

Change the Sonar Mode

The 2D Sonar data can be displayed on the full screen. You can also choose a split screen to display the beams separately, or you can display a split zoom view.

1. With a 2D Sonar View displayed on-screen, tap the Menu icon in the Top Bar, or press the MENU key once.
2. Select Settings.
3. Select Sonar Mode.
4. Select a mode to apply to the view.

Split [Zoom] Sonar Mode

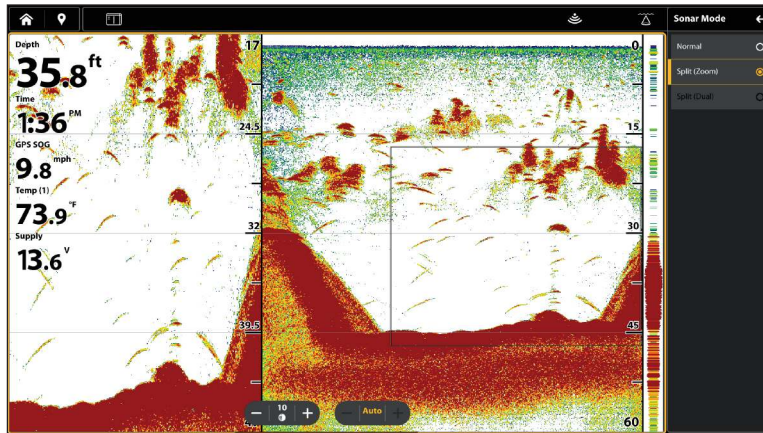

Normal	The 2D Sonar is displayed on the full screen.
Split [Zoom]	The view is split into two sides. 2D Sonar View is displayed on the right side with a zoom preview box. The zoomed view is shown on the left side. Select Split [Zoom] from the Settings menu, and you can turn on Flat Bottom and change the Zoom Window size.
Split [Dual]	The view displays sonar returns from each down beam frequency on separate sides of the screen. You can use the split mode to make side by side comparisons between the sonar returns from both beams.

Set the Zoom Mode

The Zoom Mode sets the zoom commands to magnify the full pane or the cursor selection. See *Use Cursor and Zoom in Sonar Views* to apply the zoom features.

1. With a 2D Sonar View displayed on-screen, tap the Menu icon in the Top Bar, or press the MENU key once.
2. Select Settings.
3. Select Zoom Mode.
4. Select Pane Zoom or Cursor Zoom.

Pane Zoom	When you use pinch out/in [touch screen] to zoom, or press the +/- ZOOM keys, the view will be magnified.
Cursor Zoom	When you use pinch out/in [touch screen] to zoom, or press the +/- ZOOM keys, the cursor selection will be magnified.

Change the Sonar Color Palette

The Sonar Colors menu changes the colors used to display sonar returns on the view.

1. With a 2D Sonar View displayed on-screen, tap the Menu icon in the Top Bar, or press the MENU key once.
2. Select Sonar Colors.
3. Select a color palette.

Sonar View with a Customized Palette and Background

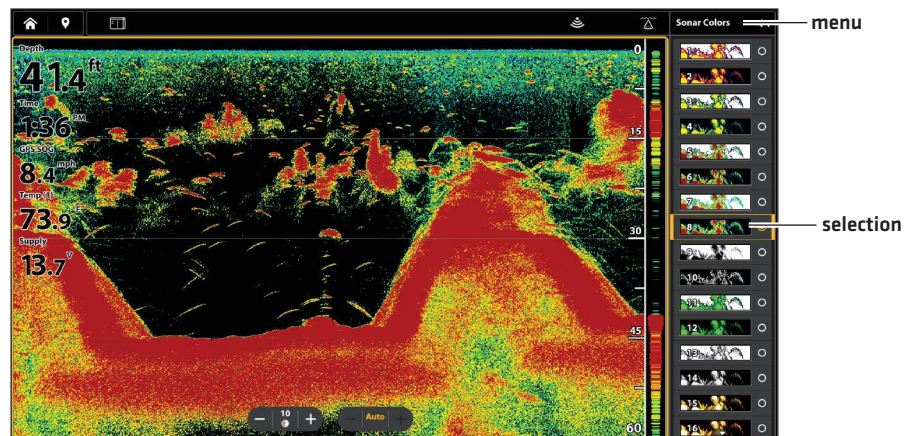

Set the Bottom View Preferences

Bottom View selects the method used to represent bottom and structure on the display. There are many ways to display the bottom on the display.

1. With a 2D Sonar View displayed on-screen, tap the Menu icon in the Top Bar, or press the MENU key once.
2. Select Settings.
3. Select Bottom View.
4. Select Structure ID or White Line. Then, select Bottom Fill and/or Bottom Line to add them to the view.

2D View with Bottom View Options Displayed

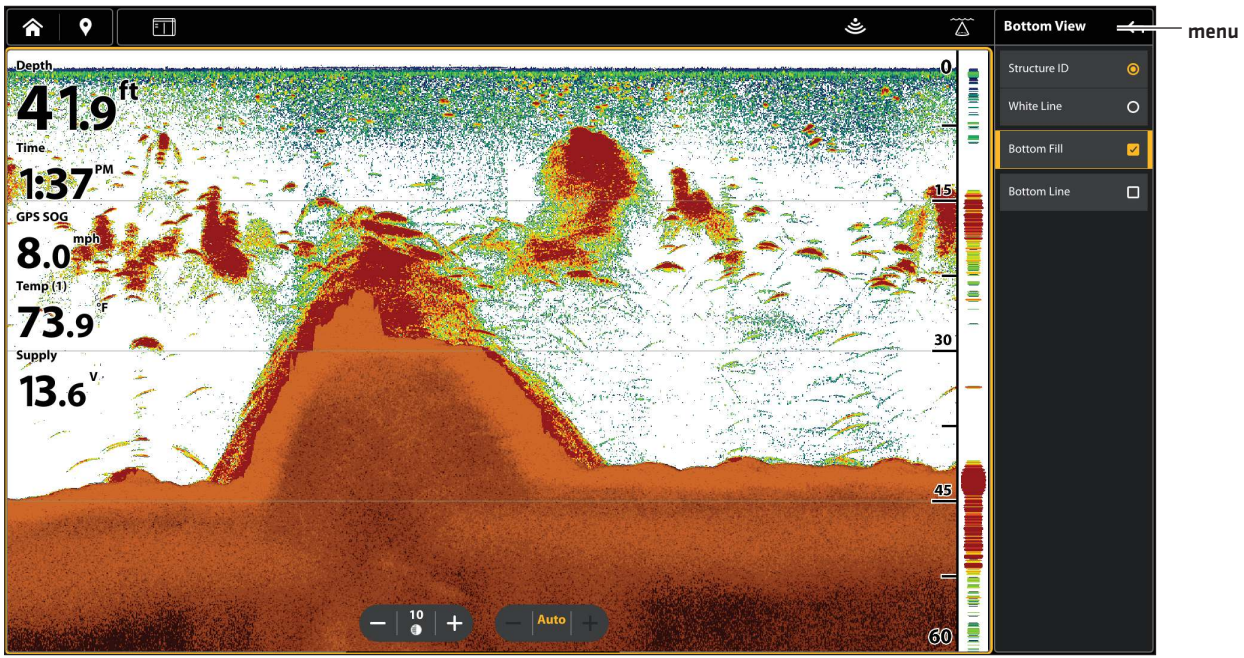

Structure ID	Structure ID represents weak returns in blue and strong returns in red (original palette). If the color palette is changed, the Structure ID will display the strongest return as specified by the palette.
White Line	White Line highlights the strongest sonar returns in white. This has the benefit of clearly defining the bottom on the display.
Bottom Fill	Select Bottom Fill to see the shaded bottom filled in with a solid color on the view. This has the benefit of clearly defining the bottom location on the display.
Bottom Line	Select Bottom Line to display the depth reading from the Depth Source as a line, either from the selected transducer or another digital depth source. See Set up your Humminbird Network for details about selecting sources.

Display the RTS Window

The RTS Window plots the depth and intensity of a sonar return. It updates at the fastest rate possible for depth conditions and shows only the returns from the bottom, structure, and fish that are within the transducer beam. When you use the cursor to review sonar history, the sonar history will pause, but the RTS Window will continue to display sonar returns in real time.

1. With a 2D Sonar View displayed on-screen, tap the Menu icon in the Top Bar, or press the MENU key once.
2. Select Settings.
3. Select RTS Window.
4. Tap the on/off button, or press the ENTER key, to turn it on. Then, choose the type of RTS Window to display.

Color [A-Scope]	Sonar returns are displayed in color. The size of the displayed lines correspond with the intensity of the sonar returns from the transducer beam[s].
Color [Full]	Sonar returns are displayed in color, and they fill the width of the RTS Window.
Mono	Sonar returns are displayed in black.

Turn on/off Fish ID+

Fish ID+ uses advanced signal processing to interpret sonar returns. When Fish ID+ is selected, fish symbols will be displayed on the Sonar View when very selective requirements are met.

When Fish ID+ is not selected, the fish finder shows only the raw sonar returns on the display. The returns appear as arches on the display to indicate potential targets.

1. With a 2D Sonar View displayed on-screen, tap the Menu icon in the Top Bar, or press the MENU key once.
2. Select Settings.
3. Select Fish ID+.
4. Use the following menu options to display fish icons, adjust the sensitivity, and more.

Fish Icons	Select Fish Icons to display fish symbols on the 2D Sonar View when a fish is detected. Blue Fish Icons = targets detected in the 200 kHz narrow beam. Orange Fish Icons = targets detected in the 83 kHz or 50 kHz wide beam.
Fish Depth	The depth of the fish is displayed above the fish icon.
ID Sensitivity	Use ID Sensitivity to adjust the threshold used for detecting a fish with Fish ID+. [1 = low sensitivity, where only a large fish will be displayed, and 10 = high sensitivity, where small fish up to large fish will be displayed]
Fish Alerts	To receive an on-screen alert when a fish is detected, turn on this menu option.

2D Sonar View with RTS Window and Fish ID+ Turned On

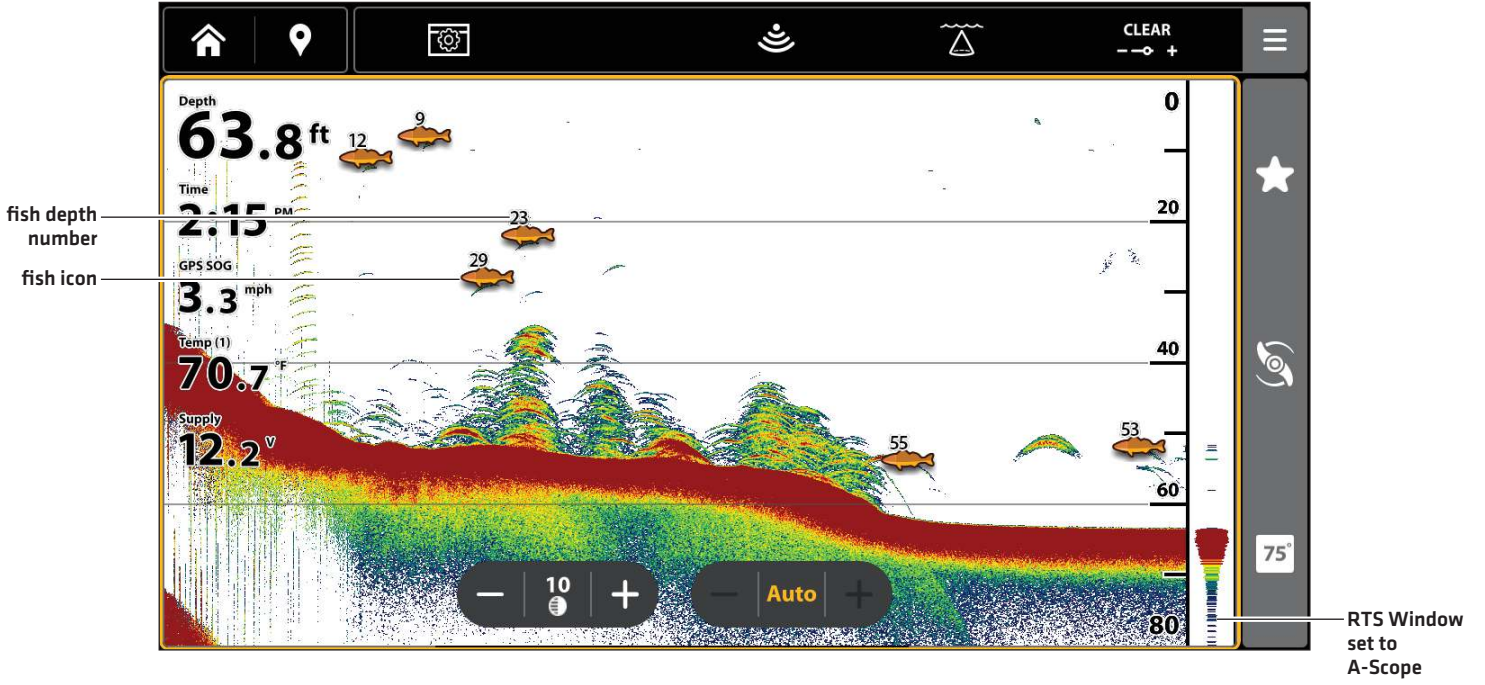

CHANGE THE 2D SONAR VIEW OVERLAYS

Use the Overlays menu to display or hide information on the view. In the 2D Sonar View, you can display the following: depth lines, depth range, depth marker, temperature graph, beam frequency label, and zoom label.

Digital readout data can be displayed as an overlay, and it can be displayed in the data bar. To turn on the data overlay or data bar, see **Views: Edit the On-Screen View**. For more information about data overlays, see **Views**.

1. With a 2D Sonar View displayed on-screen, tap the Menu icon in the Top Bar, or press the MENU key once.
2. Select Settings.
3. Select Overlays.
4. Tap the menu, or use the Cursor pad to select an item, and add a check mark. [check mark = visible, blank = hidden].

Selecting Overlays for the 2D Sonar View

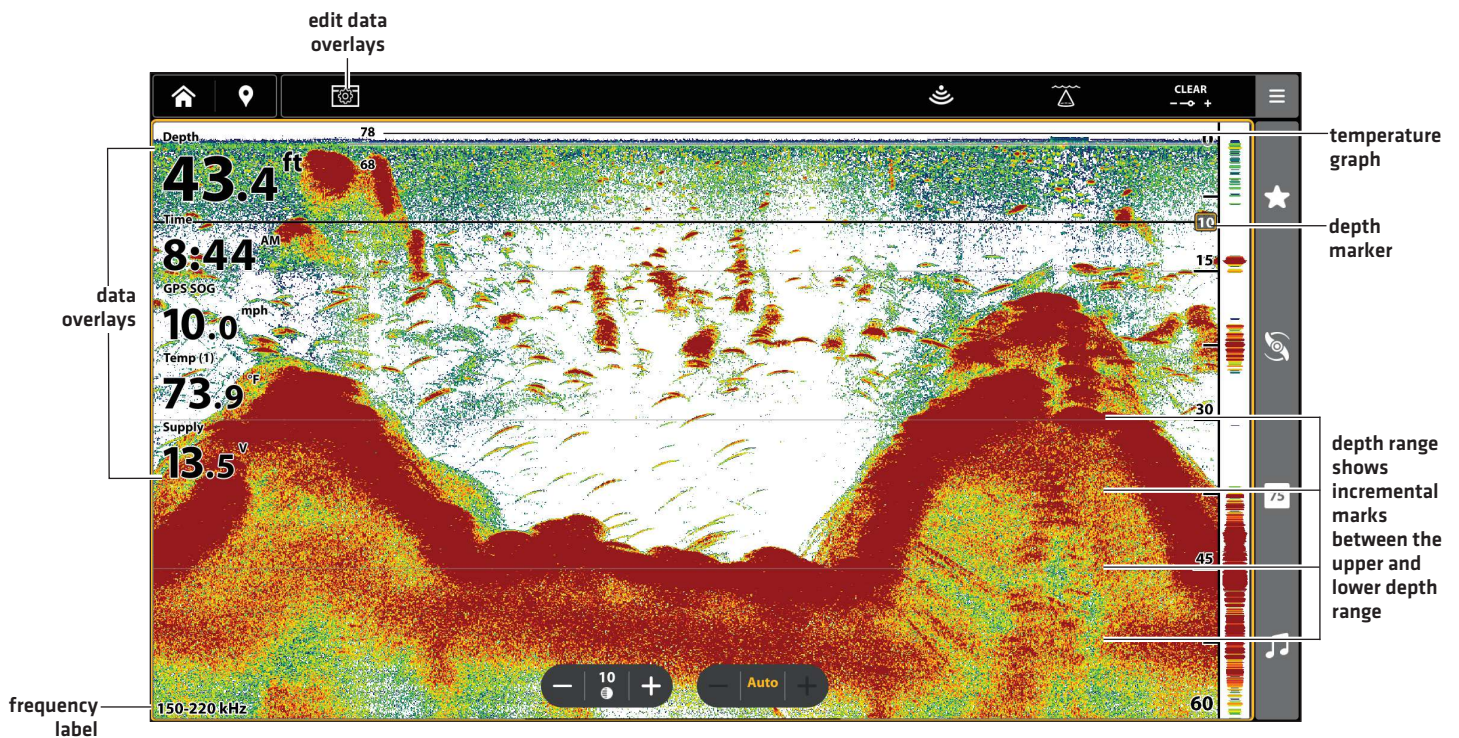

ADJUST 2D SONAR DISPLAY SETTINGS

The 2D Sonar Menu provides menu options to adjust the sensitivity and range as you fish. You can also mark a particular depth and control how fast the sonar history scrolls across the screen. The menu options allow you to see more or less of the sonar returns from the transducer beams as you adjust each setting.

Adjusting Sonar Display Settings

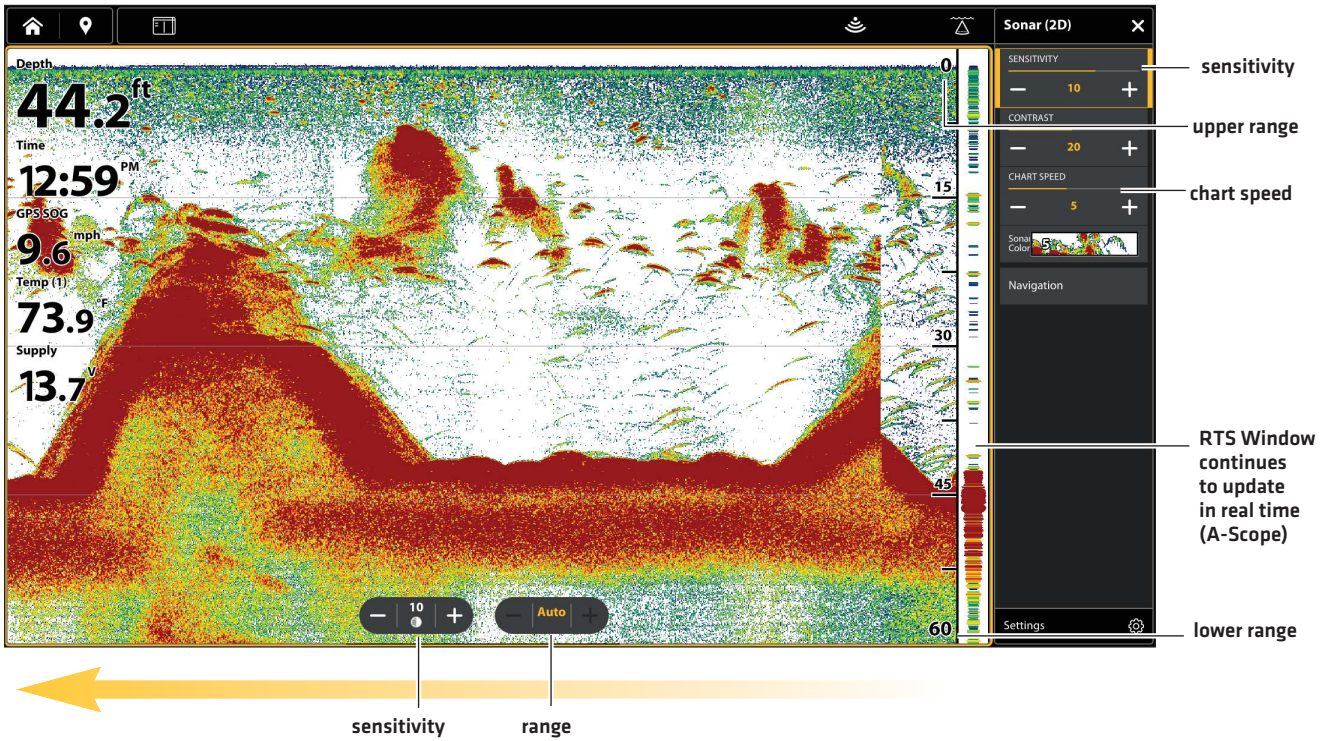

Adjust Display Settings

1. With a 2D Sonar View displayed on-screen, tap the Menu icon in the Top Bar, or press the MENU key once.
2. Select Sensitivity, Contrast, or Scroll Speed.
3. Tap the + or -, or press the +/- ZOOM keys, to adjust the setting.

Sensitivity	<p>Sensitivity controls how much detail is shown on the display and will adjust the sensitivity of all sonar frequencies. Decrease the sensitivity to eliminate the clutter from the display that is sometimes present in murky or muddy water. When operating in very clear water or greater depths, increase the sensitivity to see weaker returns that may be of interest.</p> <p>QUICK TIP! This setting can also be changed by tapping the sensitivity tool on the Sonar View.</p>
Contrast	<p>Contrast allows you to choose a range of the Sonar Colors palette to display sonar returns.</p> <p>When Contrast is set to 20 [default], the entire Sonar Colors palette [represented by the Color Bar] is used to display weak and strong sonar returns. As you increase the Contrast, the top range of the Color Bar is used to display all sonar returns [whether weak or strong]. As you decrease the Contrast, the bottom range of the Color Bar is used to display all sonar returns [whether weak or strong].</p>
Scroll Speed	<p>Scroll Speed determines how fast the sonar history moves across the display and how much detail is shown. Select a faster speed to see more detail. Select a slower speed to keep the sonar history on the display longer.</p>

Filter Surface Clutter

Use Surface Clutter to reduce the noise that may appear at the top of the view caused by algae and aeration. The lower the setting, the less surface clutter will be displayed. A higher setting allows more surface clutter to be displayed.

1. With a 2D Sonar View displayed on-screen, tap the Menu icon in the Top Bar, or press the MENU key once.
2. Select Settings.
3. Select Surface Clutter.
4. Tap the + or -, or press the +/- ZOOM keys, to adjust the setting.

Change the SwitchFire Mode

SwitchFire controls how the sonar returns are displayed in the view.

1. With a 2D Sonar View displayed on-screen, tap the SwitchFire icon **CLEAR** in the Top Bar.
2. Select Clear Mode **CLEAR** or Max Mode **MAX**.

SwitchFire: Max Mode

Tap to open the SwitchFire menu.

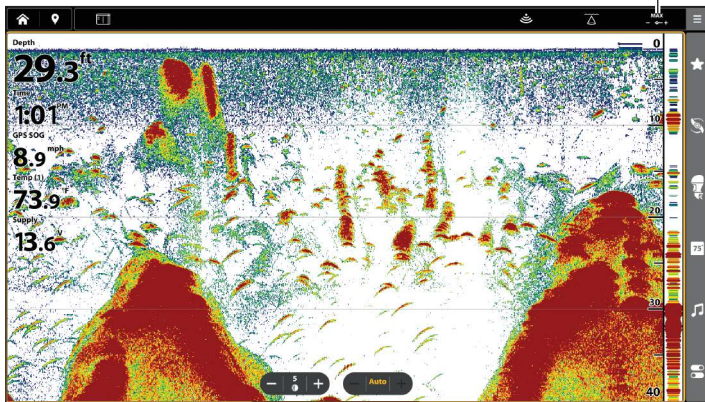

Choose Max Mode to see only raw sonar returns on the display. When Max Mode is selected, you will see the maximum sonar information available within the transducer beam, so more fish arches and better jig tracking are shown.

SwitchFire: Clear Mode

Tap to change the SwitchFire mode.

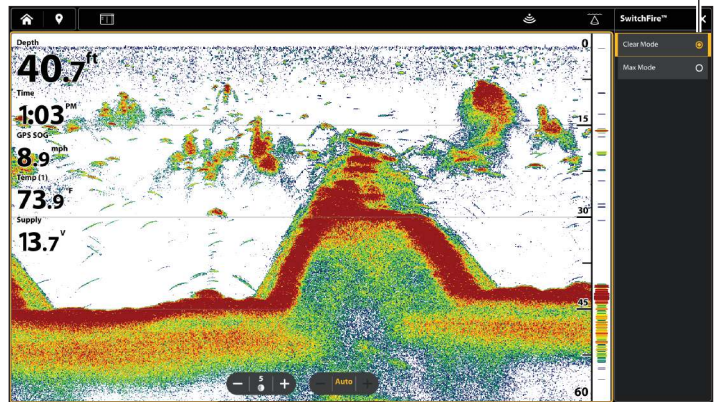

Choose Clear Mode to see less clutter and more fish size accuracy on the display. When Clear Mode is selected, the clutter is filtered, and sonar returns are interpreted to provide more details about the objects within the transducer beam, regardless of their location. In other words, a large arch on the display means a large fish has been detected.

Set the Range

Range controls how much of the water column is displayed on the view. For example, if you are only interested in the area between 20 and 50 feet deep, set the Upper Range to 20 and the Lower Range to 50. The view will not display sonar returns outside of the set ranges, and greater detail for the selected range will be displayed.

1. With a 2D Sonar View displayed on-screen, tap the Menu icon in the Top Bar, or press the MENU key once.
2. Select Settings.
3. Select Range.
4. Select Upper Range. Tap the + or -, or press the +/- ZOOM keys, to adjust the setting.

OR

Drag the slider at the bottom of the screen to adjust the setting.

5. Select Lower Range.

Auto: Move the slider to Auto. The Lower Range will be adjusted by the fish finder to follow the bottom automatically.

Man [Manual]: Move the slider to Manual and adjust the setting.

QUICK TIP! This setting can also be changed by tapping the Range button on the Sonar View.

Display the Depth Marker

To mark a specific depth on the view, turn on Depth Marker.

1. With a 2D Sonar View displayed on-screen, tap the Menu icon in the Top Bar, or press the MENU key once.
2. Select Settings.
3. Select Overlays.
4. Select Depth Marker.
5. Tap the on/off button, or press the ENTER key, to turn it on.
6. Drag the slider, or press the +/- ZOOM keys, to adjust the setting.

Select Frequencies

If there are multiple beams available in a transducer, you can display individual frequencies on the 2D Sonar View. The menu options are determined by the installed transducer and control head model. See *Installation Information: Set up your Humminbird Network*, *Select Sonar Sources* and *Set up or Change Transducer Settings* for details.

Dual Beam CHIRP Models

1. With a 2D Sonar View displayed on-screen, tap the Display Frequency icon **800 kHz** in the Top Bar.
2. Select a frequency from the list.



QUICK TIP! This setting can also be changed by pressing and holding the ENTER key.

NOTE

If the fish finder is using a sonar source with only one beam frequency, the frequency list will not offer additional options.

Dual Spectrum High Wide Models

1. With a 2D Sonar View displayed on-screen, tap the Display Spectrum icon  in the Top Bar.
2. Select a spectrum from the list.

	Full	Select Full Beam [default] to use the complete frequency range.
	Narrow	Select Narrow Beam for increased bottom detail and better target separation.
	Wide	Select Wide Beam to maximize coverage and show big, clearly defined fish arches.

2D Sonar View

Tap to open the Display Spectrum menu in the Top Bar.

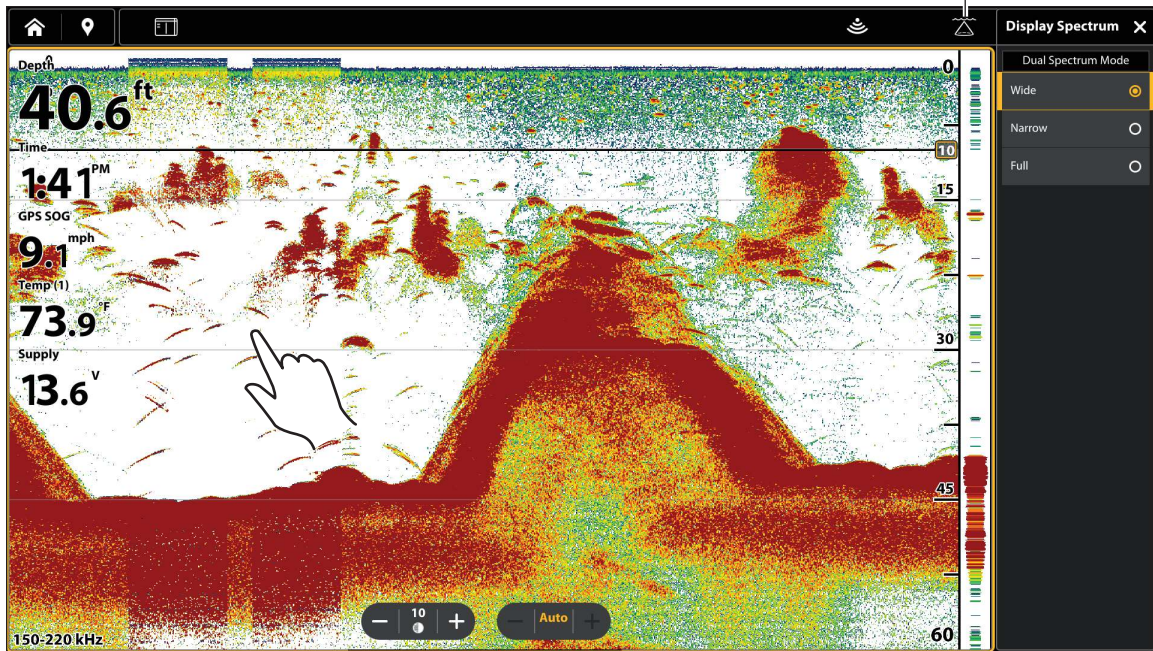

Adjust Beam Sensitivity

Your fish finder model may allow you to adjust the sensitivity of individual frequencies. The available frequencies are determined by your fish finder model and the installed transducer. Use the following instructions to adjust a single beam.

1. Tap the Sensitivity tool on the Sonar View.

OR

1. With a 2D Sonar View displayed on-screen, tap the Menu icon in the Top Bar, or press the MENU key once.
2. Select Sensitivity.
3. Tap the + or -, or press the +/- ZOOM keys, to adjust the setting.

SIDE IMAGING OVERVIEW

(SIDE IMAGING TRANSDUCER REQUIRED)

Side Imaging beams “illuminate” the bottom contour, structure, and fish. The side beam coverage is very thin from front to back, yet very wide from top to bottom. The bottom composition determines the intensity of the sonar return, and upward slopes that face the transducer reflect sonar better than downward slopes that face away from the transducer.

Side Imaging View

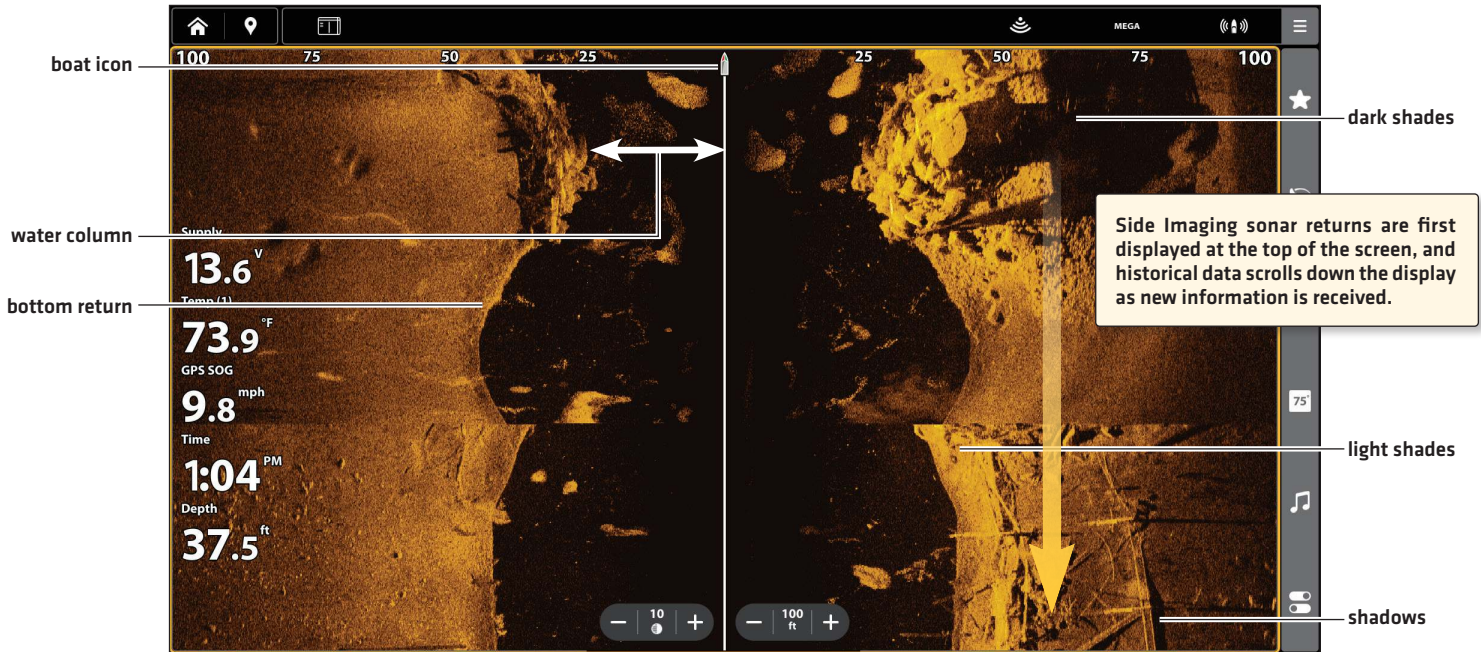

Use the light and dark parts of the display to interpret the objects on the view as follows:

Shadows: The longer the shadow, the taller the object. Fish also cast shadows, and their distance from the bottom can be interpreted by their shadow.

Light Shades represent denser terrain [possibly compacted sediment, timber, rocks] or rising terrain.

Water Column: shows the relative depth of the water under the vessel at any given time. Variations in the width of the water column show variations in the distance to the bottom as the vessel passes over. See the illustration *Interpreting the Side Imaging View*.

White Streaks or **Clouds** may represent fish on the display.

Dark Shades represent soft returns [possibly sand or mud] or descending terrain.

Interpreting the Side Imaging View

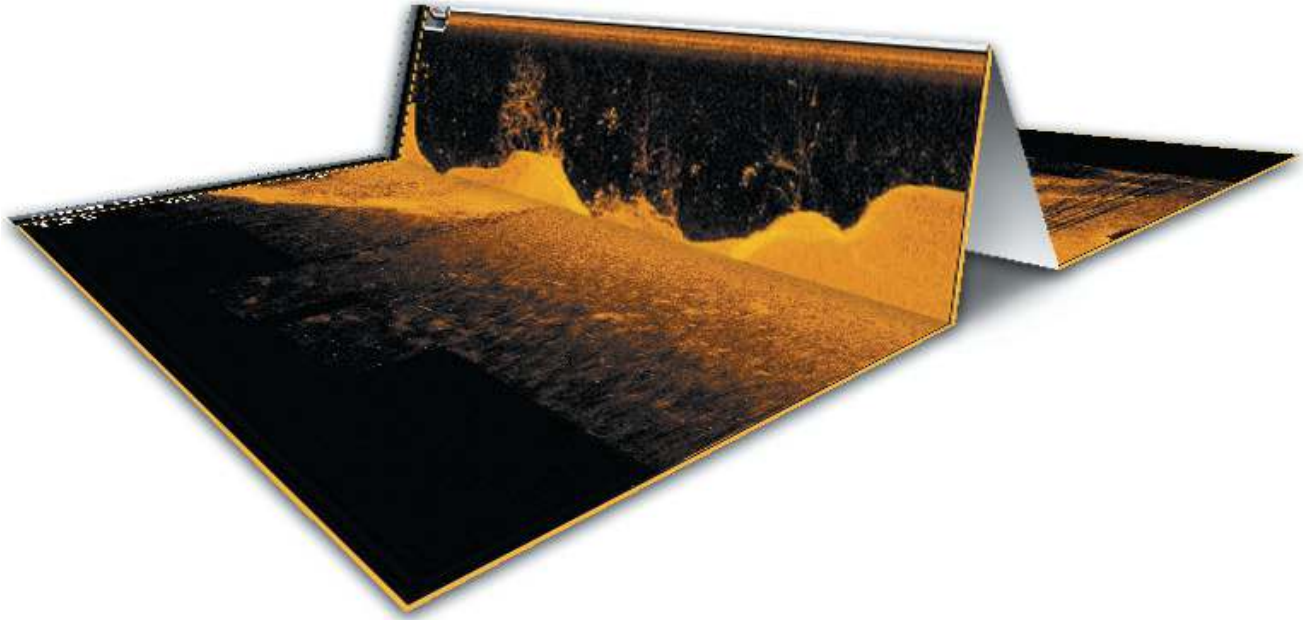

To visualize how Side Imaging works, the Side Imaging View illustration can be folded down the middle and then folded again at the lowest point of the water column. The raised area reveals the water column with its relative depth of the water under the vessel. In the Side Imaging View, variations in the width of the water column show variations in the distance to the bottom as the vessel passes over.

For Best Side Imaging Performance

- Vessel Speed: 2 to 6 mph
- Straight line navigation
- Minimum turning time and wave turbulence

Also, see humminbird.johnsonoutdoors.com for tutorials and Side Imaging videos.

CUSTOMIZE THE SIDE IMAGING VIEW

The settings in this section are optional. You can use the default settings for the view, or you can customize it with your preferences. See **Views** for more information.

OPEN THE SIDE IMAGING X-PRESS MENU

The Side Imaging menu allows you to select a beam to display, set the zoom mode, color palette, and turn on Contour Mode and SI Navigation. For more information about view preferences, see **Views**.

1. With a Side Imaging View displayed on-screen, tap the Menu icon in the Top Bar, or press the MENU key once.
2. Select a display option or select Settings.

Select Beams to Display

The Side Imaging View displays both beams on the view. You can also choose to display the left side or the right side of the Side Imaging transducer beams.

1. With a Side Imaging View displayed on-screen, tap the SI Side icon () in the Top Bar.
2. Select a side to display.

OR

1. With a Side Imaging View displayed on-screen, tap the Menu icon in the Top Bar, or press the MENU key once.
2. Select Settings.
3. Select SI Side.
4. Select a side to display.

Change the Color Palette

The Sonar Colors menu changes the colors used to display sonar returns on the view.

1. With a Side Imaging View displayed on-screen, tap the Menu icon in the Top Bar, or press the MENU key once.
2. Select Sonar Colors.
3. Select a color palette.

Side Imaging View with a Customized Palette

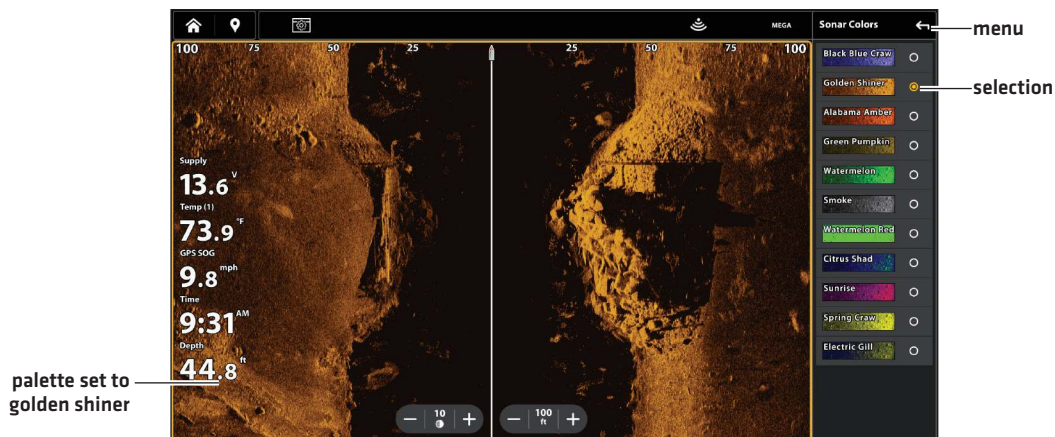

Turn on/off Dynamic Contrast

Dynamic Contrast automatically enhances the contrast of the selected color palette.

1. With a Side Imaging View displayed on-screen, tap the Menu icon in the Top Bar, or press the MENU key once.
2. Select Dynamic Contrast, and tap the on/off button, or press the ENTER key, to turn it on/off.

Turn on/off Contour Mode

Contour Mode controls how the water column is displayed in the Side Imaging Views. When Contour Mode turned off, the water column is displayed on the view. The location of a target on the display is based on the slant range to the target.

When Contour Mode is turned on, the bottom is graphed at a constant point on the display, regardless of changes in depth. The Side Imaging beams are divided by a vertical line. The water column is removed from the view, which allows the display to show targets at their linear horizontal distance. The location of a target may be easier to interpret when the water column is removed.

1. With a Side Imaging View displayed on-screen, tap the Menu icon in the Top Bar, or press the MENU key once.
2. Select Settings.
3. Select Contour mode, and tap the on/off button, or press the ENTER key, to turn it on/off.

Contour Mode Off

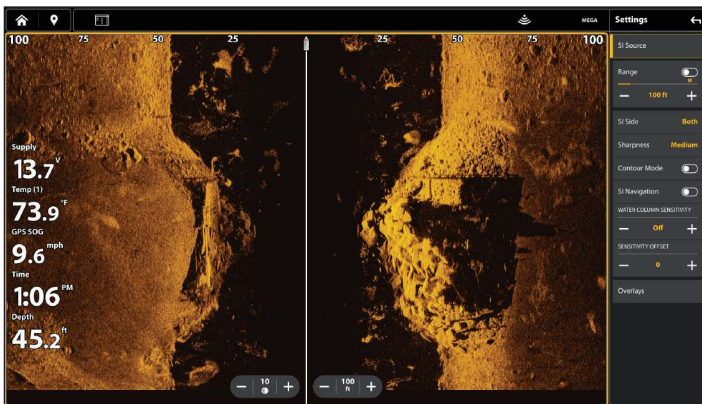

The water column is displayed on the Side Imaging View.

Contour Mode On

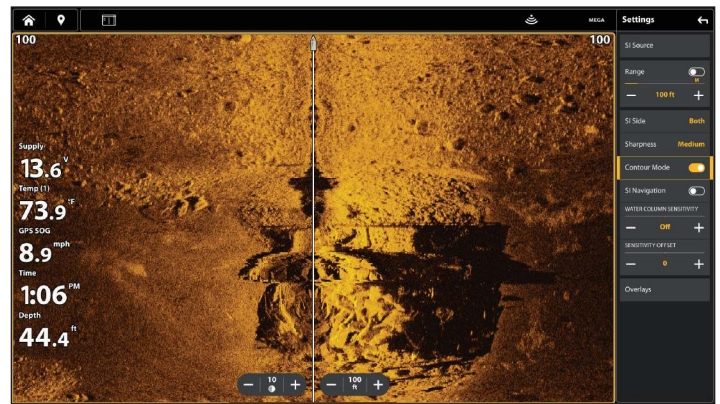

The water column is removed from the Side Imaging View.

Turn on/off SI Navigation

SI Navigation controls how the boat icon is displayed in Side Imaging Views. See *Navigation in Sonar Views* for more information. If SI Navigation is turned on, the boat icon indicates the direction the boat needs to turn to reach the next waypoint during navigation.

If SI Navigation is turned Off, the boat icon will not change during navigation although you can still mark waypoints and start navigation from a Side Imaging View.

1. With a Side Imaging View displayed on-screen, tap the Menu icon in the Top Bar, or press the MENU key once.
2. Select Settings.
3. Select SI Navigation, and tap the on/off button, or press the ENTER key, to turn it on/off.

CHANGE THE SIDE IMAGING VIEW OVERLAYS

Use the Overlays menu to display or hide information on the view. In the Side Imaging View, you can display the following: boat icon, range lines, range intervals, side label, frequency label, and data overlays. To turn on the data overlay or data bar, see **Views: Edit the On-Screen View**. For more information about data overlays, see **Views**.

1. With a Side Imaging View displayed on-screen, tap the Menu icon in the Top Bar, or press the MENU key once.
2. Select Settings.
3. Select Overlays.
4. Tap the menu, or use the Cursor pad/Joystick to select an item, and add a check mark. [check mark = visible, blank = hidden].

Selecting Overlays for the Side Imaging View

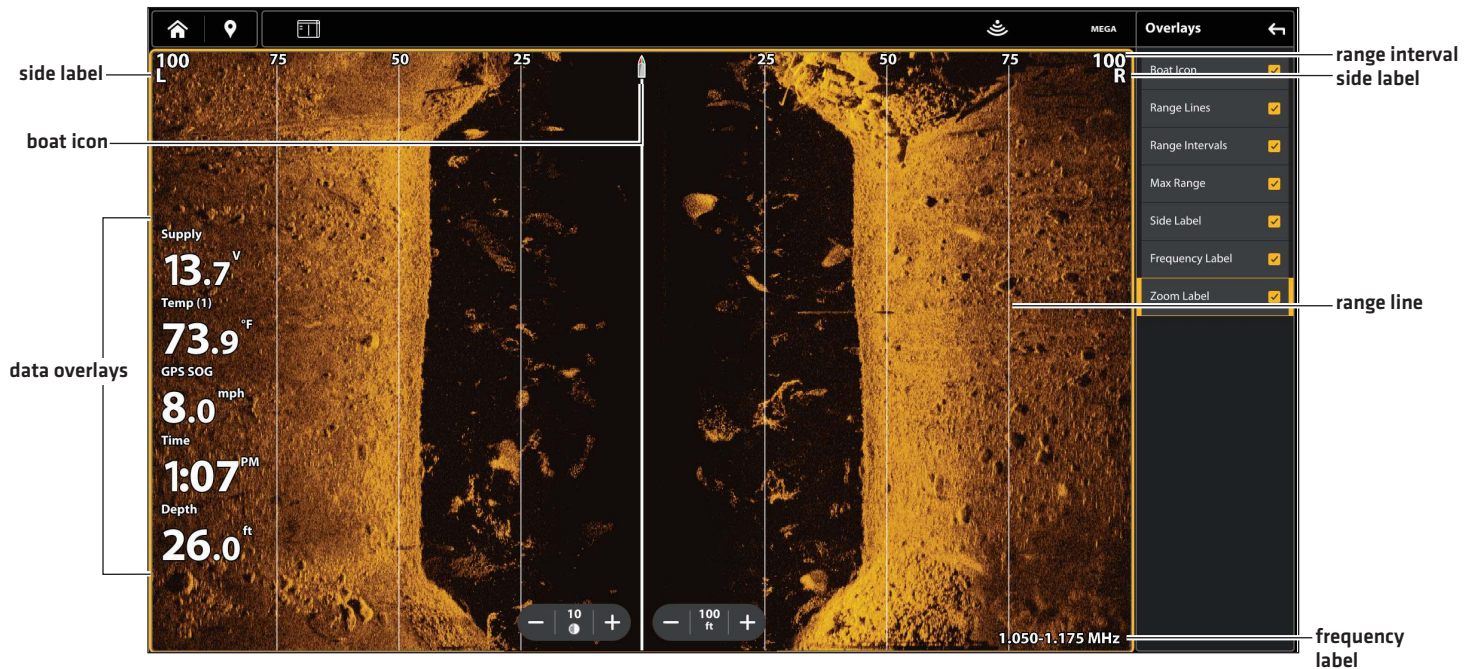

ADJUST SIDE IMAGING DISPLAY SETTINGS

The Side Imaging Menu provides menu options to adjust the sensitivity, contrast, sharpness, water column sensitivity, and range as you fish. You can also mark a particular range, and you can control how fast the sonar history scrolls across the screen. The menu options allow you to see more or less of the sonar returns from the transducer beams as you adjust each setting.

Adjust Display Settings

1. With a Side Imaging View displayed on-screen, tap the Menu icon in the Top Bar, or press the MENU key once.
2. Select Sensitivity, Contrast, or Chart Speed.
3. Drag the slider, or press the +/- ZOOM keys, to adjust the setting.

Adjusting Side Imaging Display Settings

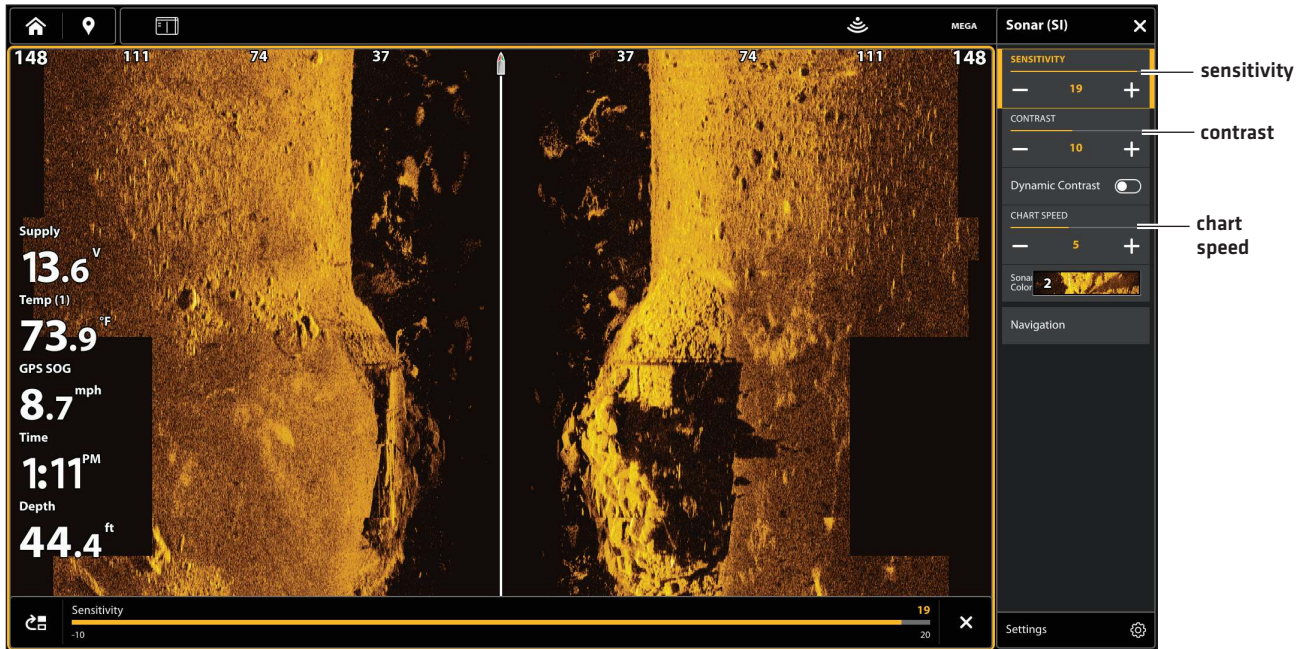

QUICK TIP! The Sensitivity setting can also be changed by tapping the Sensitivity tool on the SI View.

<p>Sensitivity</p>	<p>Sensitivity controls how much detail is shown on the display and will adjust the sensitivity of all sonar frequencies. Decrease the sensitivity to eliminate the clutter from the display that is sometimes present in murky or muddy water. When operating in very clear water or greater depths, increase the sensitivity to see weaker returns that may be of interest.</p> <p>QUICK TIP! The Sensitivity setting can also be changed by tapping the Sensitivity tool on the SI View.</p>
<p>Contrast</p>	<p>Adjust the Contrast setting to accent the light and dark parts of the Side Imaging data to provide greater definition.</p>
<p>Chart Speed</p>	<p>Chart Speed determines how fast the sonar history moves down the display and how much detail is shown. Select a faster speed to see more detail. Select a slower speed to keep the sonar history on the display longer.</p>

Adjust Water Column Sensitivity

The Water Column Sensitivity settings is used to increase or decrease the sensitivity of the sonar return that is in the water column.

1. With a Side Imaging View displayed on-screen, tap the Menu icon in the Top Bar, or press the MENU key once.
2. Select Settings.
3. Select Water Column Sensitivity.
4. Drag the slider, or press the +/- ZOOM keys, to adjust the setting.

Adjust the Sharpness

Turn on Sharpness and select a filter level to sharpen the edges of the Side Imaging data.

1. With a Side Imaging View displayed on-screen, tap the Menu icon in the Top Bar, or press the MENU key once.
2. Select Settings.
3. Select Sharpness.
4. Tap the on/off button, or press the ENTER key, to turn it on/off.
5. Select filter level of Low, Medium, or High.

Set the Range

Range controls how much of the water column is displayed on the view.

1. With a Side Imaging View displayed on-screen, tap the Menu icon in the Top Bar, or press the MENU key once.
2. Select Settings.
3. Select Range.
4. Tap the toggle to select Auto or M [Manual], or press the ENTER key.
5. If M [Manual] is selected, tap the + or -, or press the +/- ZOOM keys, to adjust the setting.

Auto: Toggle to Auto. The Range will be adjusted by the fish finder to follow the bottom automatically.

M [Manual]: Toggle to M [Manual] and adjust the setting.

QUICK TIP! The Range can also be changed by tapping the Range tool on the SI View.

Auto	The Range will be adjusted by the fish finder to follow the bottom automatically.
M [Manual]	To adjust the display range, drag the slider, or press the +/- ZOOM keys. Select a low range number to focus on a shorter distance of the water column and see greater detail on the screen. Select a higher range number to view farther into the water and see an overview of details on the screen.

Select Frequencies

If there are multiple beams available in a transducer, you can display individual frequencies on the view. See **Installation Information: Set up your Humminbird Network, Select Sonar Sources** and **Set up or Change Transducer Settings** for details.

1. With a Side Imaging View displayed on-screen, tap the frequency icon in the Top Bar.
2. Select a frequency from the list.

455 kHz

800 kHz

MEGA

QUICK TIP! This setting can also be changed by pressing and holding the ENTER key.

NOTE

If the fish finder is using a sonar source with only one beam frequency, the frequency list will not offer additional options.

Adjust the SI Sensitivity Offset

In the unlikely event that your Side Imaging transducers are not tuned to the same level, you can offset the left Side Imaging beam from the right Side Imaging beam.

1. With a Side Imaging View displayed on-screen, tap the Menu icon in the Top Bar, or press the MENU key once.
2. Select Settings.
3. Select Sensitivity Offset.
4. Drag the slider, or press the +/- ZOOM keys, to adjust the setting.

Adjusting the SI Sensitivity Offset

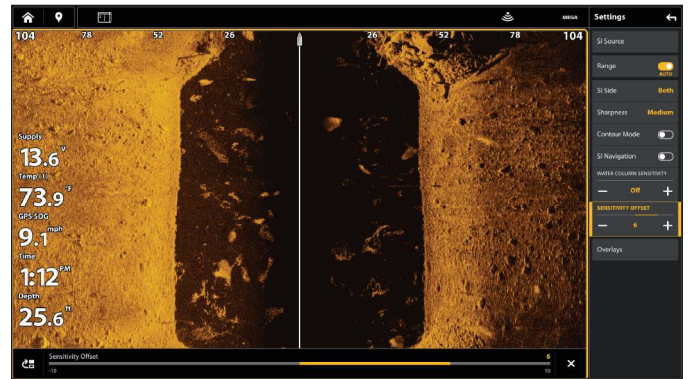

Turn on Contour Mode

1. With a Side Imaging View displayed on-screen, tap the Menu icon in the Top Bar, or press the MENU key once.
2. Select Settings.
3. Select Contour Mode.
4. Tap the on/off button, or press the ENTER key, to turn it on/off.

Turn on SI Navigation

1. With a Side Imaging View displayed on-screen, tap the Menu icon in the Top Bar, or press the MENU key once.
2. Select Settings.
3. Select SI Navigation.
4. Tap the on/off button, or press the ENTER key, to turn it on/off.

DOWN IMAGING OVERVIEW

(DOWN IMAGING TRANSDUCER OR SIDE IMAGING TRANSDUCER REQUIRED)

The images you see on the Down Imaging display are produced using sonar technology. Each time the unit pings, a strip of data representing all the echoes received by the transducer are put together on the display to form the image that you see. Like traditional 2D Sonar, the sonar history scrolls left across the screen.

Down Imaging beams “illuminate” the bottom contour, structure, and fish. The beams are wide [side to side] but very thin from front to back.

Down Imaging View: Original Palette

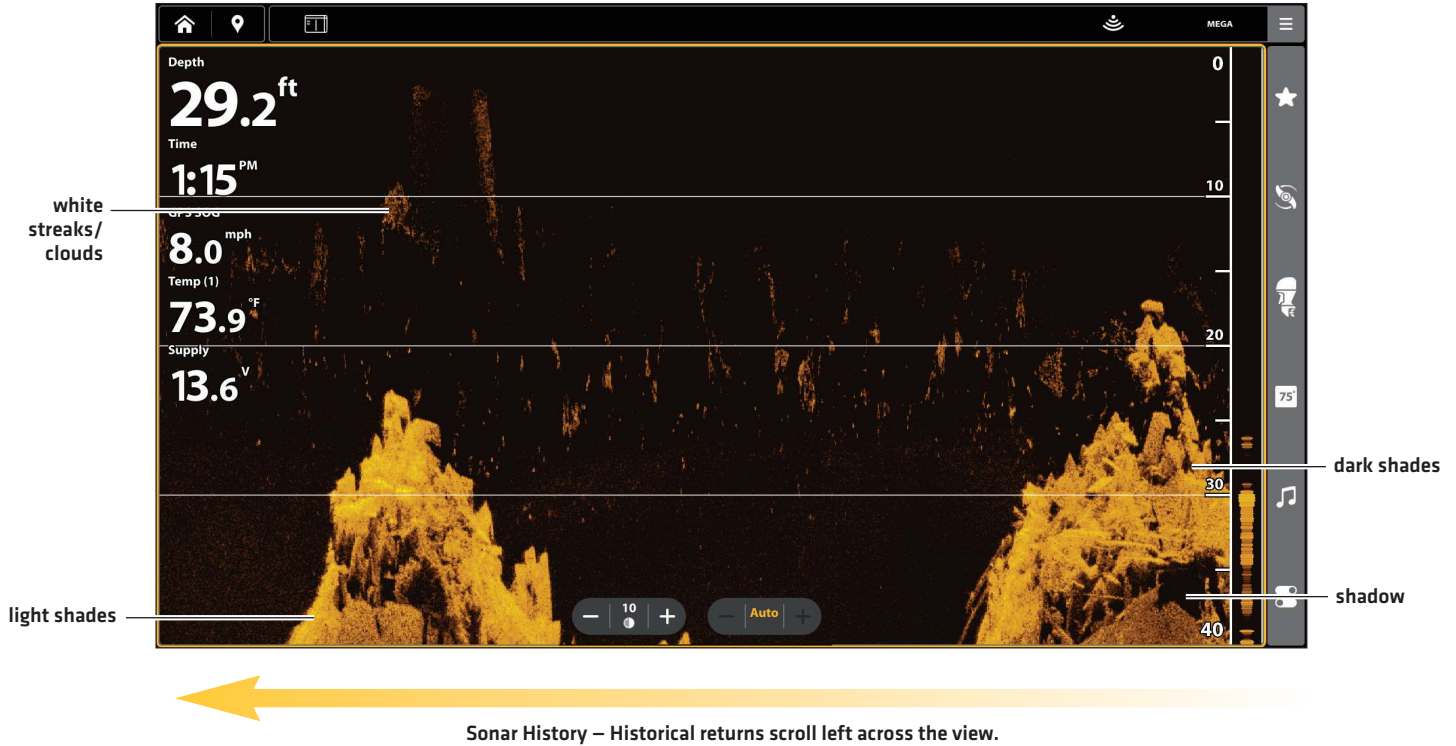

Use the light and dark parts of the display to interpret the objects under your boat as follows:

Dark shades represent soft returns (mud, sand) or descending terrain.

Light shades represent denser terrain (timber, rocks) or rising terrain. A very hard bottom may appear as white on the display.

White Streaks or **Clouds** may represent fish on the display.

Shadows are not caused by light but by the lack of a sonar return. Objects standing on the bottom cause a sonar shadow to appear on the display. The longer the shadow, the taller the object. Fish may also cast shadows. You can use the shadow to interpret where the fish or object is located in relation to the bottom.

CUSTOMIZE THE DOWN IMAGING VIEW

The settings in this section are optional. You can use the default settings for the view, or you can customize it with your preferences. See **Views** for more information.

OPEN THE DOWN IMAGING X-PRESS MENU

The Down Imaging menu allows you to set the color palette, zoom mode, and bottom line. For more information about view preferences, see **Views**.

1. With a Down Imaging View displayed on-screen, tap the Menu icon in the Top Bar, or press the MENU key once.
2. Select a display option or select Settings.

Change the Color Palette

The Sonar Colors menu changes the colors used to display sonar returns on the view.

1. With a Down Imaging View displayed on-screen, tap the Menu icon in the Top Bar, or press the MENU key once.
2. Select Sonar Colors.
3. Select a color palette.

Down Imaging View with a Customized Sonar Color

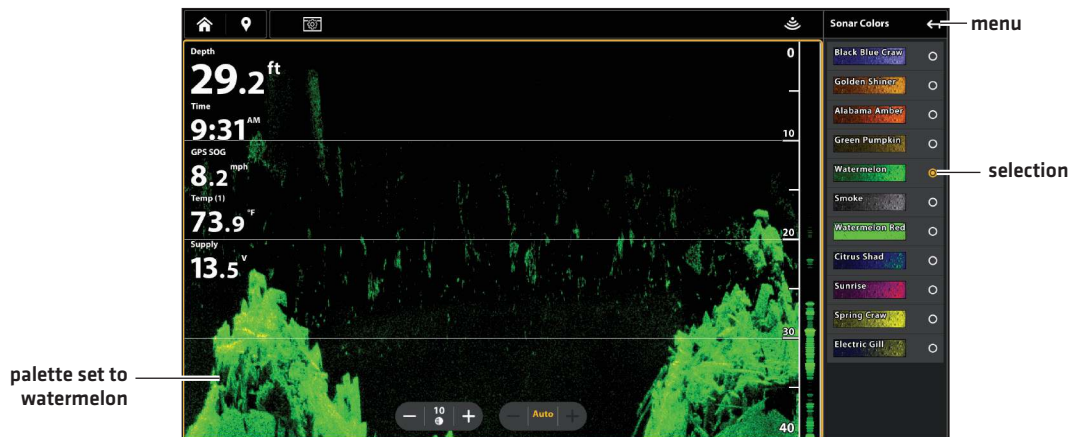

Turn on/off Dynamic Contrast

Dynamic Contrast automatically enhances the contrast of the selected color palette.

1. With a Down Imaging View displayed on-screen, tap the Menu icon in the Top Bar, or press the MENU key once.
2. Select Dynamic Contrast.
3. Tap the on/off button, or press the ENTER key, to turn it on/off.

Set the Zoom Mode

The Zoom Mode sets the zoom commands to magnify the full pane or the cursor selection. See *Use Cursor and Zoom in Sonar Views* to apply the zoom features.

1. With a Down Imaging View displayed on-screen, tap the Menu icon in the Top Bar, or press the MENU key once.
2. Select Settings.
3. Select Zoom Mode.
4. Select Pane Zoom or Cursor Zoom.

Pane Zoom	When you use pinch out/in [touch screen] to zoom, or press the +/- ZOOM keys, the view will be magnified.
Cursor Zoom	When you use pinch out/in [touch screen] to zoom, or press the +/- ZOOM keys, the cursor selection will be magnified.

Display the Bottom Line

Add a check mark to Bottom Line to display the depth reading from the Depth Source as a line, either from the selected transducer or another digital depth source. See *Set up your Humminbird Network* for details about selecting sources.

1. With a Down Imaging View displayed on-screen, tap the Menu icon in the Top Bar, or press the MENU key once.
2. Select Settings.
3. Select Bottom Line, and tap the on/off button, or press the ENTER key, to turn it on/off.

Down Imaging View with Bottom Line Displayed

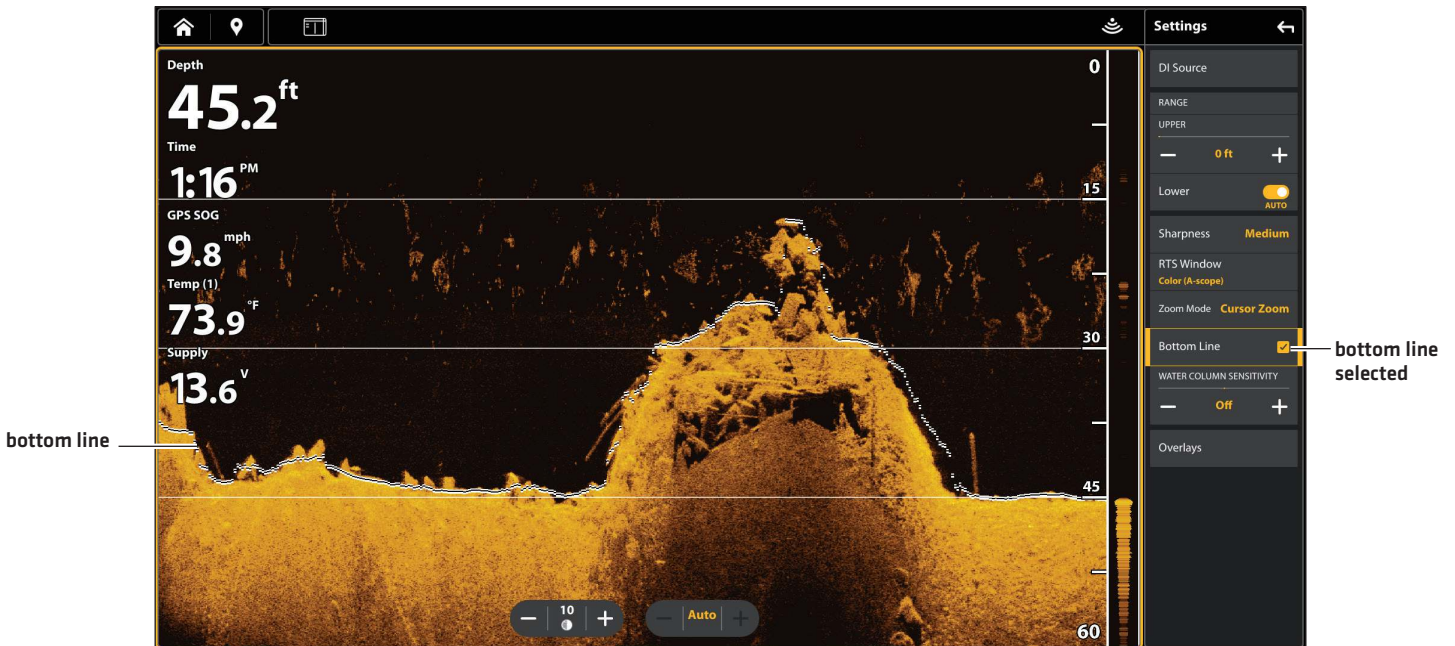

Display the RTS Window

The RTS Window plots the depth and intensity of a sonar return. It updates at the fastest rate possible for depth conditions and shows only the returns from the bottom, structure, and fish that are within the transducer beam. When you use the cursor to review sonar history, the sonar history will pause, but the RTS Window will continue to display sonar returns in real time.

1. With a Down Imaging View displayed on-screen, tap the Menu icon in the Top Bar, or press the MENU key once.
2. Select Settings.
3. Select RTS Window.
4. Tap the on/off button, or press the ENTER key, to turn it on. Then, choose the type of RTS Window to display.

Color [A-Scope]	Sonar returns are displayed in color. The size of the displayed lines correspond with the intensity of the sonar returns from the transducer beam[s].
Color [Full]	Sonar returns are displayed in color, and they fill the width of the RTS Window.
Mono	Sonar returns are displayed in black.

CHANGE THE DOWN IMAGING VIEW OVERLAYS

Use the Overlays menu to display or hide information on the view. In the Down Imaging View, you can display the following: depth lines, depth range, depth marker, beam frequency label, and zoom label. Digital readout data can be displayed as an overlay, and it can be displayed in the data bar. To turn on the data bar, see **Views: Display a Data Bar**. For more information about data overlays, see **Views**.

1. With a Down Imaging View displayed on-screen, tap the Menu icon in the Top Bar, or press the MENU key once.
2. Select Settings.
3. Select Overlays.
4. Tap the menu, or use the Cursor pad/Joystick to select an item, and add a check mark. [check mark = visible, blank = hidden].

Selecting Overlays for the Down Imaging View

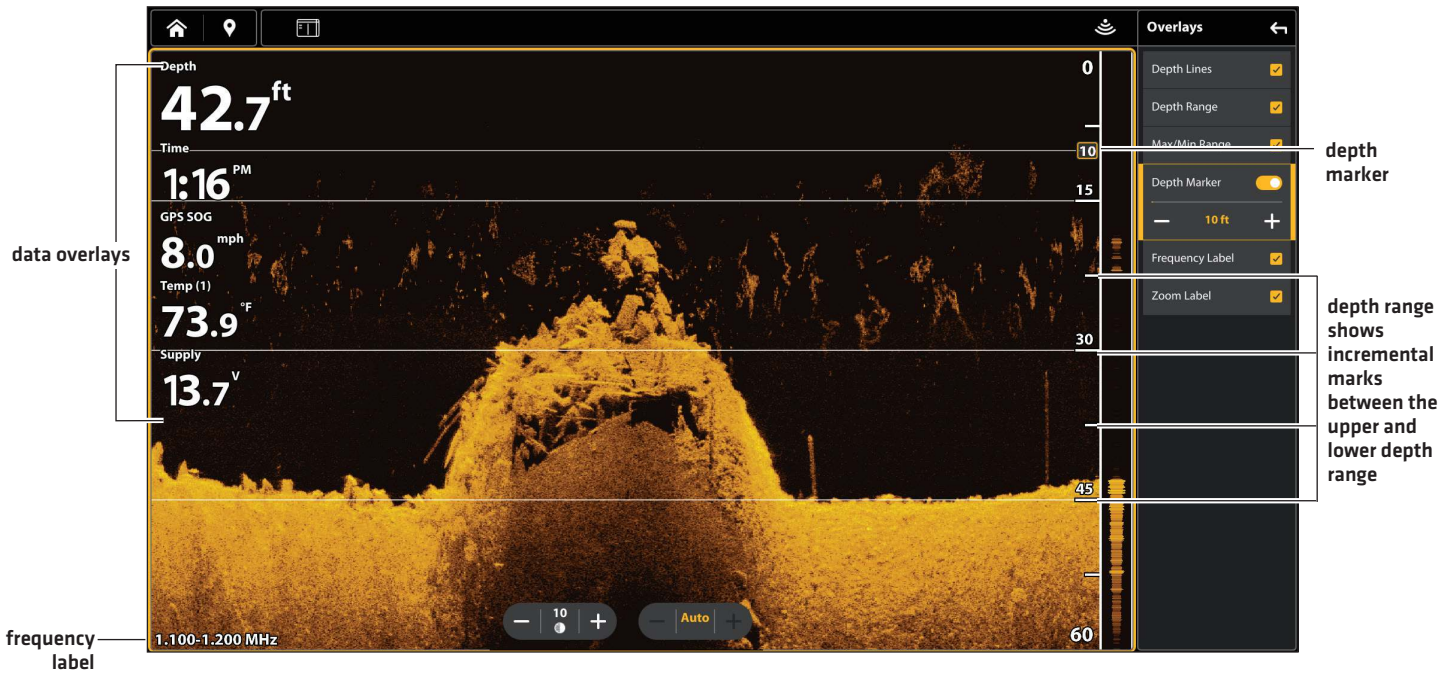

ADJUST DOWN IMAGING DISPLAY SETTINGS

The Down Imaging Menu provides options to adjust the sensitivity, contrast, and range as you fish. You can also control how fast the sonar history scrolls across the screen. The menu options allow you to see more or less of the sonar returns from the transducer beams as you adjust each setting.

Adjust Display Settings

1. With a Down Imaging View displayed on-screen, tap the Menu icon in the Top Bar, or press the MENU key once.
2. Select Sensitivity, Contrast, or Chart Speed.
3. Drag the slider, or press the +/- ZOOM keys, to adjust the setting.

Adjusting Down Imaging Display Settings

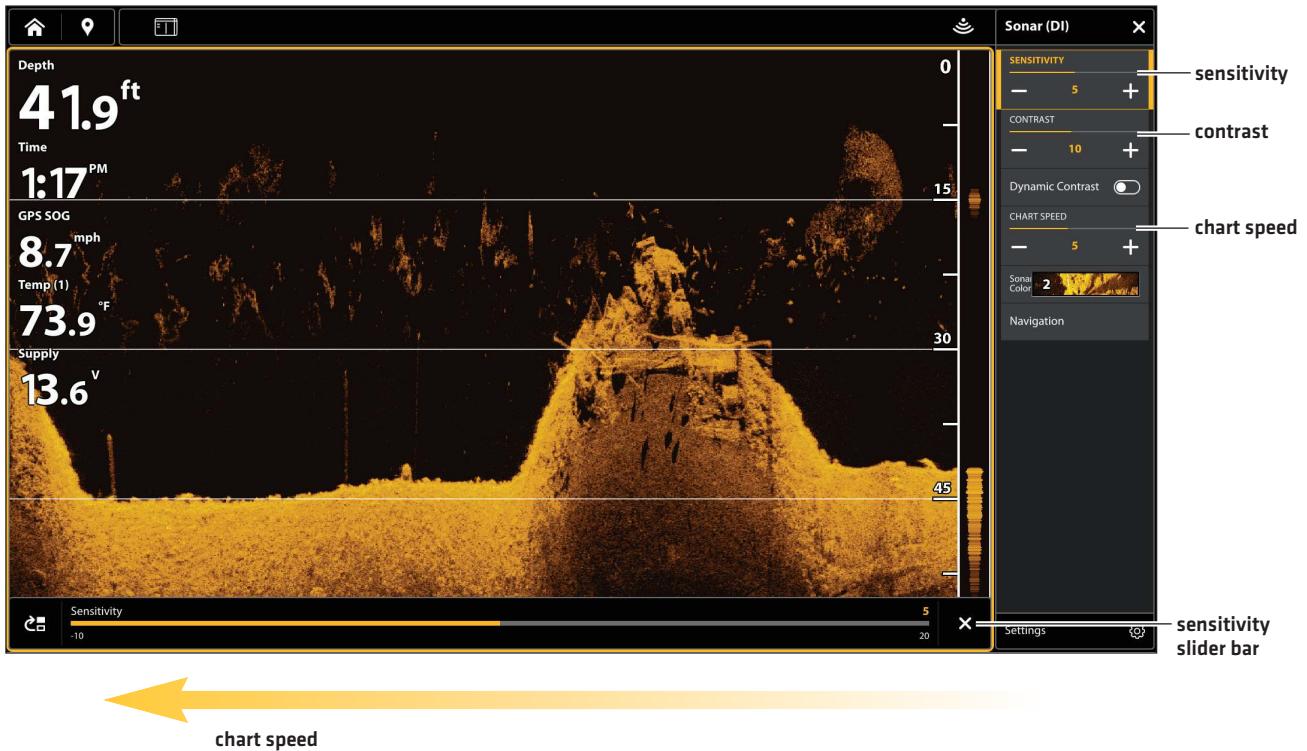

QUICK TIP! The Sensitivity setting can also be changed by tapping the Sensitivity tool on the DI View.

Sensitivity	Sensitivity controls how much detail is shown on the display and will adjust the sensitivity of all sonar frequencies. Decrease the sensitivity to eliminate the clutter from the display that is sometimes present in murky or muddy water. When operating in very clear water or greater depths, increase the sensitivity to see weaker returns that may be of interest. QUICK TIP! The Sensitivity setting can also be changed by tapping the Sensitivity tool on the DI View.
Contrast	Adjust the Contrast setting to accent the light and dark parts of the Down Imaging data to provide greater definition.
Chart Speed	Chart Speed determines how fast the sonar history moves across the display and how much detail is shown. Select a faster speed to see more detail. Select a slower speed to keep the sonar history on the display longer.

Adjust Water Column Sensitivity

The Water Column Sensitivity settings is used to increase or decrease the sensitivity of the sonar return that is in the water column.

1. With a Down Imaging View displayed on-screen, tap the Menu icon in the Top Bar, or press the MENU key once.
2. Select Settings.
3. Select Water Column Sensitivity.
4. Drag the slider, or press the +/- keys, to adjust the setting.

Adjust the Sharpness

Turn on Sharpness and select a filter level to sharpen the edges of the Down Imaging data.

1. With a Down Imaging View displayed on-screen, tap the Menu icon in the Top Bar, or press the MENU key once.
2. Select Settings.
3. Select Sharpness.
4. Tap the on/off button, or press the ENTER key, to turn it on/off.
5. Select filter level of Low, Medium, or High.

Set the Range

Range controls how much of the water column is displayed on the view. For example, if you are only interested in the area between 20 and 50 feet deep, set the Upper Range to 20 and the Lower Range to 50. The view will not display sonar returns outside of the set ranges, and greater detail for the selected range will be displayed.

1. With a Down Imaging View displayed on-screen, tap the Menu icon in the Top Bar, or press the MENU key once.
2. Select Settings.
3. Select Range.
4. Select Upper Range. Drag the slider, or press the +/- keys, to adjust the setting.
5. Select Lower Range.

Auto: Toggle to Auto. The Lower Range will be adjusted by the fish finder to follow the bottom automatically.

M [Manual]: Toggle to M [Manual] and adjust the setting.

QUICK TIP! The Range can also be changed by tapping the Range tool on the DI View.

Select Frequencies

If there are multiple beams available in a transducer, you can display individual frequencies on the view. See **Installation Information: Set up your Humminbird Network, Select Sonar Sources** and **Set up or Change Transducer Settings** for details.

1. With a Down Imaging View displayed on-screen, tap the DI Frequency icon in the Top Bar.
2. Select a frequency from the list.

455 kHz

800 kHz

MEGA

QUICK TIP! This setting can also be changed by pressing and holding the ENTER key.

NOTE

If the fish finder is using a sonar source with only one beam frequency, the frequency list will not offer additional options.

You can use the cursor in the 2D Sonar, Side Imaging, and Down Imaging Views. With the cursor activated, you can magnify sonar returns on the view to get a closer look.

NOTE

To display the 2D Sonar View in Split Zoom mode, see *Customize the 2D Sonar View: Change the Sonar Mode*.

Change the Zoom Mode

In 2D Sonar View and Down Imaging View, the sonar returns will be magnified based on the Zoom Mode setting. You can magnify the full view [Pane Zoom] or a selected area of the view [Cursor Zoom]. See *Customize the 2D Sonar View* or *Customize the Down Imaging View* for more information.

Touch Screen

1. With a 2D Sonar View or Down Imaging View displayed on-screen, tap the Menu icon in the Top Bar.
2. Select Settings.
3. Select Zoom Mode.
4. Select Pane Zoom or Cursor Zoom.

Keypad

1. With a 2D Sonar View or Down Imaging View displayed on-screen, press the MENU key once.
2. Select Settings.
3. Select Zoom Mode.
4. Select Pane Zoom or Cursor Zoom.

Activate the Cursor

Touch Screen

1. Tap a position on the 2D Sonar, Down Imaging, or Side Imaging View.

Keypad

1. Move the Joystick or Cursor pad.

Zoom In/Out

Touch Screen

1. **Zoom In:** Touch the screen with two fingers and move them apart [pinch out].
2. **Zoom Out:** Touch the screen with two fingers and move them together [pinch in].

Keypad

1. **Zoom In:** Press the +ZOOM key.
2. **Zoom Out:** Press the - ZOOM key.

Using Cursor Zoom Mode (2D Sonar View)

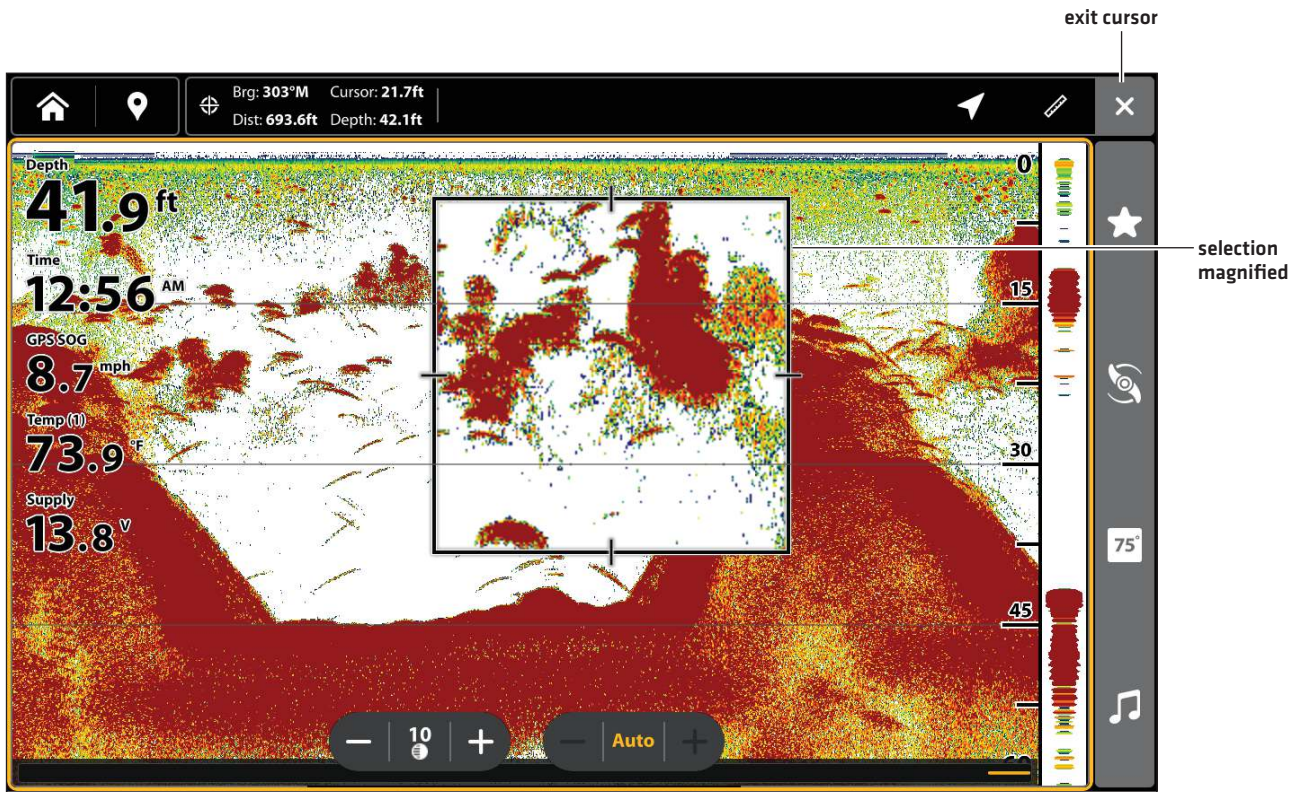

To mark waypoints and start navigation, the fish finder must have a GPS fix from a connected or internal GPS receiver. The navigation menus can be accessed from the X-Press Menu, touch screen, and the keypad.

Mark a Waypoint

You can mark a waypoint on the Sonar Views using the keypad or touch screen. You can also mark a waypoint at the vessel position or the cursor position.

Mark a Waypoint at the Vessel Position

Touch Screen

1. Select the Mark icon  in the Top Bar.
2. Select a Waypoint icon from the Favorites menu.

Keypad

1. Press the MARK key.
2. Select a Waypoint icon from the Favorites menu.

Mark a Waypoint at the Cursor Position

Touch Screen

1. Press and hold a position on the Sonar View.
2. Select a Waypoint icon from the Favorites menu.

Keypad

1. Use the Cursor pad/Joystick to move the cursor to a position on the Sonar View.
2. Press the MARK key.
3. Select a Waypoint icon from the Favorites menu.

Marking a Waypoint in 2D Sonar View

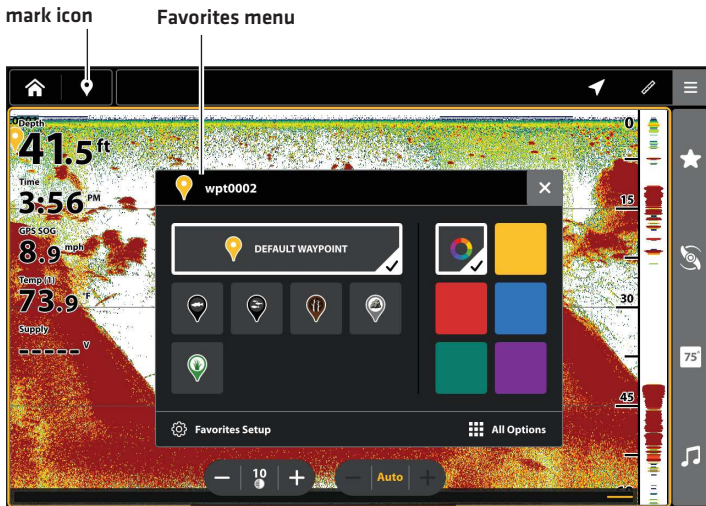

Waypoint in 2D Sonar View

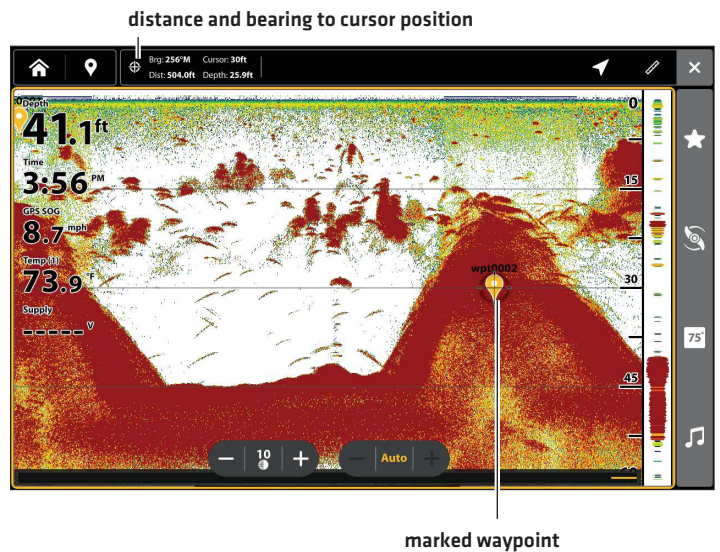

Navigate to a Position

Use the instructions in this section to start navigation to a position in the Sonar Views. See *Introduction to Navigation* for more information about these features.

Start Navigation

1. Tap a position on the Sonar View to activate the cursor, or use the Cursor pad/Joystick to move the cursor to a position on the view.
2. Press the GO TO key.

OR

Press the MENU key, and select Navigation.

3. Select Go To Cursor. Navigation will begin.

NOTE

In Side Imaging Views, if SI Navigation is turned on, the boat icon will turn to indicate the direction the boat needs to turn to reach the next waypoint during navigation [see *Customize the Side Imaging View: Turn on/off SI Navigation*].

Cancel Navigation

1. During navigation, tap the Menu icon in the Top Bar. Select Go To.

OR

Press the GO TO key.

2. Select Cancel Navigation.

SONAR RECORDING

Use the Sonar Recording tool to record active sonar information. Sonar recordings are saved to an installed SD card, and you can play your saved sonar recordings from the Record tool. When the recording is played back, the views that were active during the recording are available. You can also adjust the view settings and mark waypoints during playback.

NOTE

A microSD or SD card must be installed in the fish finder to use the Recording features.

Start Recording

When you start a sonar recording, you can select which beams will be recorded and where the sonar recording will be saved.

1. Press the HOME key.
2. Select Tools.
3. Select the Record tool.
4. Select Record Sonar, and set up the sonar recording:
Select Recording Sources, and select the beams to be recorded.
Select Save Location, and select an installed SD card.

5. Select Start Recording.

The Sonar Recording icon  will display in the Top Bar.

Stop Recording

1. Press the HOME key.
2. Select Tools.
3. Select the Record tool.
4. Under Record, select Stop Recording.

OR

1. With a Sonar View on-screen, tap the Menu icon in the Top Bar, or press the MENU key once.
2. Select Stop Recording.

Play a Sonar Recording

1. Press the HOME key.
2. Select Tools.
3. Select the Record tool.
4. Tap the recording name, or use the Cursor pad/Joystick to select it.
5. Select Start.

Open the Playback Control Menu

The Playback Control menu includes stop, pause, forward or reverse for the recording played on the screen.

1. Play a sonar recording.
2. Tap the Play icon  from the Top Bar.

Sonar Recording Playback Menu

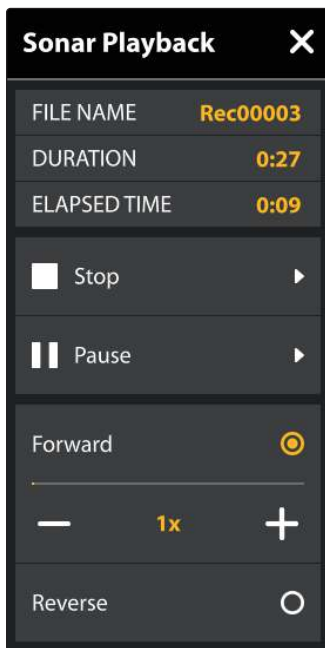

Stop Playback

1. Press the HOME key.
2. Select Tools.
3. Select the Record tool.
4. Tap the recording name, or use the Cursor pad/Joystick to select it.
5. Select Stop.

OR

1. With a Sonar View on-screen, tap the Menu icon in the Top Bar, or press the MENU key once.
2. Tap the Play icon ► from the Top Bar to open the Playback menu.
3. Select Stop.

Delete a Recording

1. Press the HOME key.
2. Select Tools.
3. Select the Record tool.
4. Press and hold the recording name.
5. Select Delete.

IMAGES TOOL

The Images tool displays the screen snapshots saved to the fish finder or to the installed SD cards. You can edit, rename, copy, and delete a screen snapshot.

Take a Screen Snapshot

Use the screen snapshot feature to take a picture of the on-screen view. The screen snapshot includes the warnings, menus, and messages that were active when the screen snapshot was taken. If Create Waypoint is turned on, a waypoint will be marked when you take the screen snapshot. See **Screen Snapshot Settings** for details.



1. Press Screen Snapshot key.

Open the Images Tool

Open the Images tool to see all the screen snapshots saved to the fish finder or installed SD cards. You can also view each save location individually, and the images can be sorted by name, date, or file type.

Open the Images Tool

1. Press the HOME key.
2. Select Tools.
3. Select the Images tool.

Browsing Screen Snapshots in the Images Tool

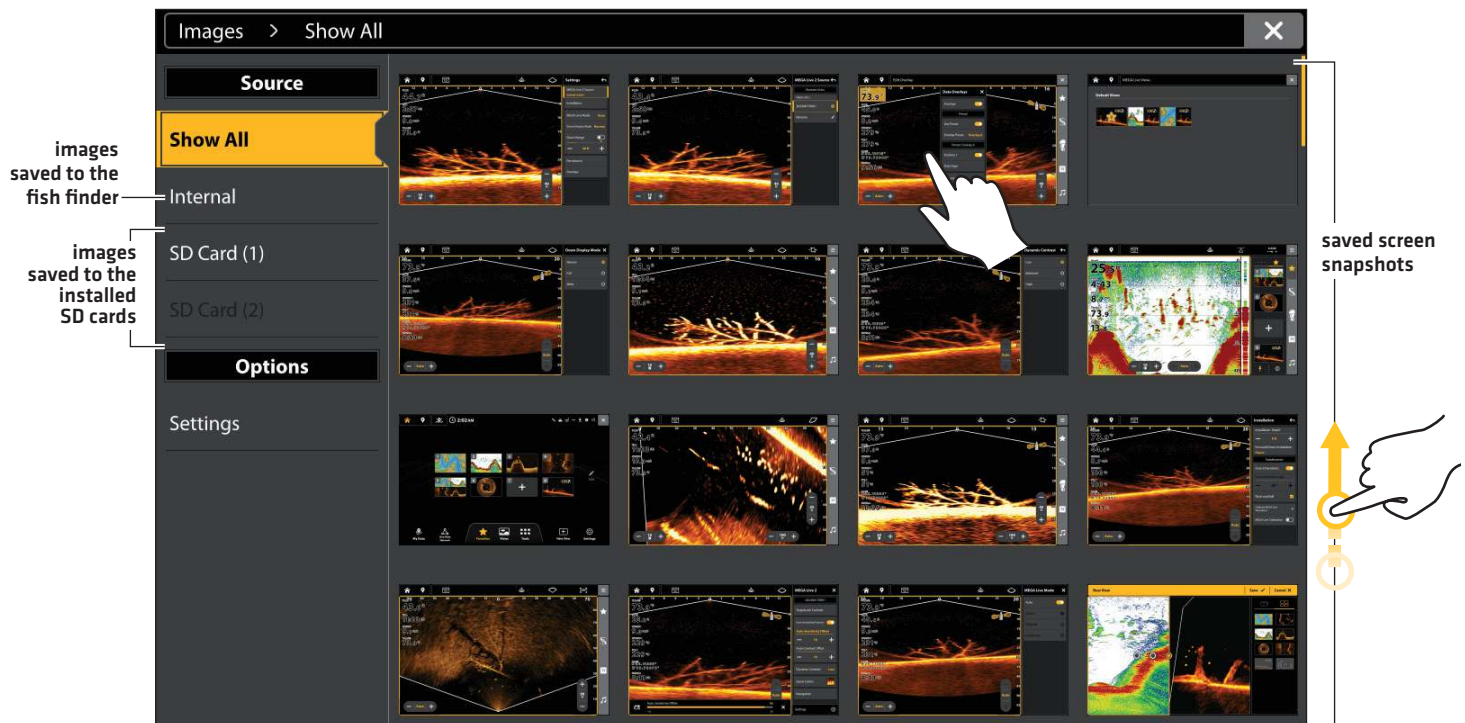

Sort Screen Snapshots

1. From the Images tool, select Settings.
2. Select Sort Options.
3. Select a sort option to sort by Name, Date, or File Type.

To view the images from newest to oldest, select Reverse Order. Tap the on/off button, or press the ENTER key, to turn it on.

Screen Snapshot Settings

Screen snapshots are automatically saved to the fish finder as JPG files. To save screen snapshots to an SD card, set up the save location in advance. If you turn on Create Waypoint, each time a screen snapshot is taken, the waypoint position will be saved.

Save Screen Snapshots to an SD Card

1. Install an SD card into a fish finder port.
2. Press the HOME key.
3. Select Tools.
4. Select the Images tool.
5. Select Settings.
6. Under Screen Capture Save Location, select an installed source:

Fish Finders with Vertical SD Card Slots: left port = SD Card 1 or right port = SD Card 2; default = Internal

Fish Finders with Horizontal SD Card Slots: top port = SD Card 1 or bottom port = SD Card 2; default = Internal

Selecting a Save Location

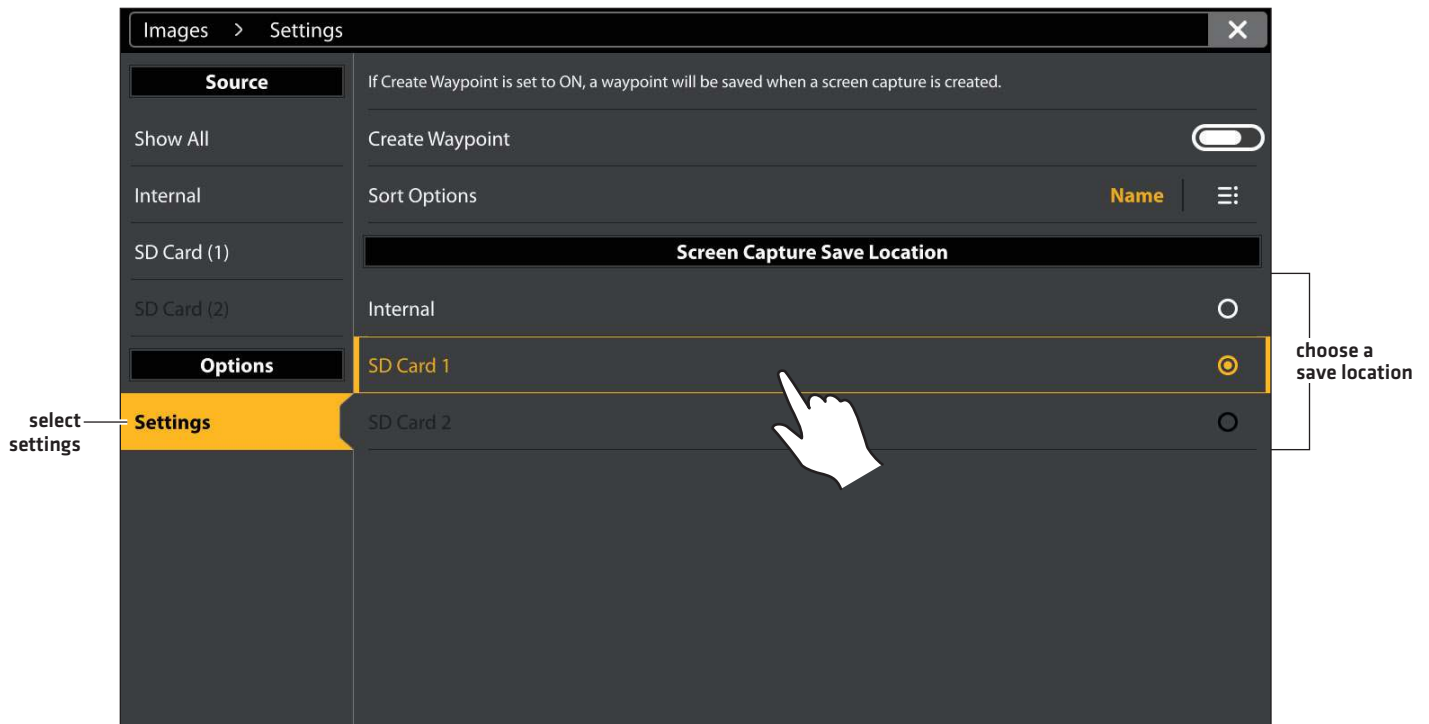

Create a Waypoint with Screen Snapshot

If you turn on Create Waypoint in the Images tool, each time a screen snapshot is taken, the waypoint position will be saved.

1. Press the HOME key.
2. Select Tools.
3. Select the Images tool.
4. Select Settings.
5. Select Create Waypoint. Tap the on/off button, or press the ENTER key, to turn it on.

When a screen snapshot is taken with Create Waypoint turned on, the screen snapshot will display a waypoint icon in the Images tool preview.

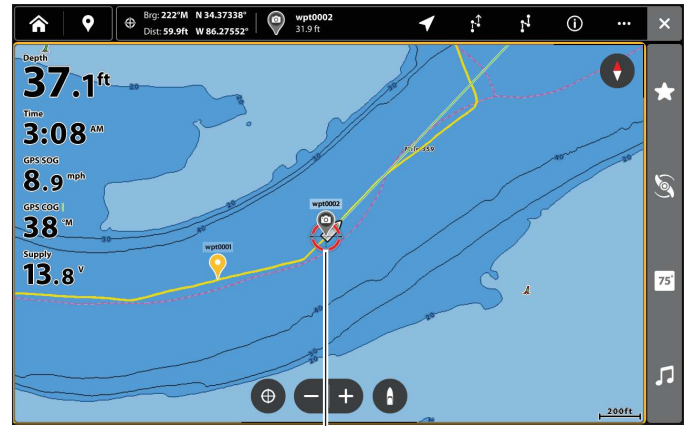

screen snapshot saved with Create Waypoint turned on

Display Screen Snapshots and Slideshow

When you select a saved screen snapshot (JPG file) from the Images tool, you can display it in full-screen using the touch screen or keypad.

Using the Touch Screen with a Saved Screen Snapshot

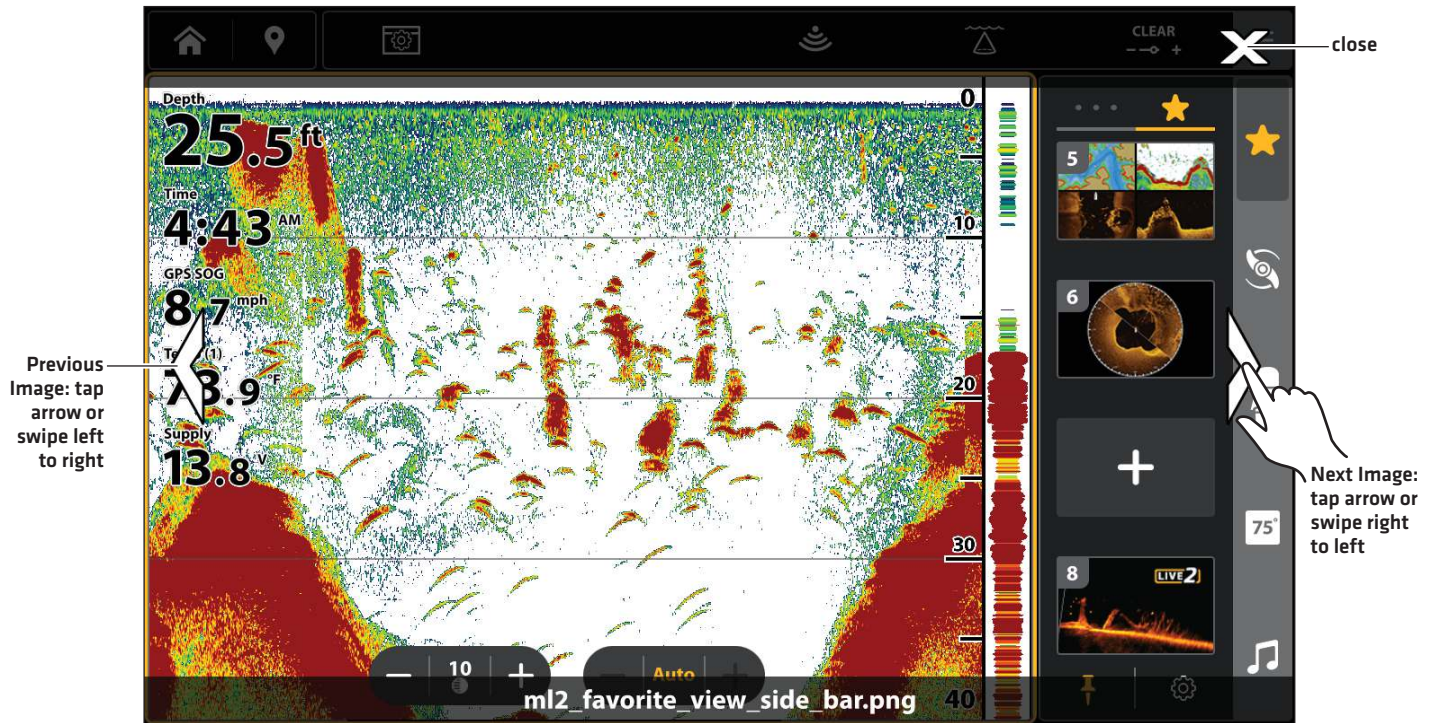

Display a Screen Snapshot

Touch Screen

1. From the Images tool, tap a screen snapshot.

Scroll to the Next Image/Previous Image:

Tap the on-screen arrows.

Return to the Images Tool:

Tap the on-screen X icon.

Keypad

1. Use the Joystick to select a screen snapshot.
2. Press the ENTER key.

Scroll to the Next Image/Previous Image:

Turn the Rotary dial.

Return to the Images Tool:

Press the EXIT key.

Edit Screen Snapshots

The Images Options menu allows you to edit the name and review the file information for the selected screen snapshot. You can also copy screen snapshots to another save location or delete them.

Change a Screen Snapshot Name

1. From the Images tool, press and hold a screen snapshot.

OR

Use the Cursor pad/Joystick to select a screen snapshot. Press the MENU key.

2. Select Name. Use the on-screen keyboard to enter a name.
3. Select Save.

Review Screen Snapshot Information

When you save a screen snapshot, the date and time the screen snapshot was taken is saved. If Create Waypoint is turned on, the position and waypoint name are also saved with the screen snapshot. Use these instructions to review the saved information.

1. From the Images tool, press and hold a screen snapshot.

OR

Use the Cursor pad/Joystick to select a screen snapshot. Press the MENU key.

2. Select Info.

Copy a Screen Snapshot

1. From the Images tool, press and hold a screen snapshot.

OR

Use the Cursor pad/Joystick to select a screen snapshot. Press the MENU key.

2. Select Copy.

To copy all screen snapshots, select Copy All.

3. Select a location to save the copy.

Delete a Screen Snapshot

1. From the Images tool, press and hold a screen snapshot.

OR

Use the Cursor pad/Joystick to select a screen snapshot. Press the MENU key.

2. Select Delete.

To delete all screen snapshots, select Delete All.

INSTALLATION INFORMATION

This section includes information that may be required to connect new equipment or a new accessory to the fish finder. There are several configurations available for your fish finder. You can network fish finders, connect accessories to an Ethernet network, and connect to a NMEA 2000 network. For configuration options and the latest Humminbird accessories, visit our Web site at humminbird.johnsonoutdoors.com.

Installation guides are included with each hardware component to install equipment purchased separately (transducer, heading sensor, radar, AIS, autopilot, and accessories). See your installation guides for details.

Unused Ports: Any unused ports should be covered with the port covers to prevent potential damage to the fish finder.

Cables: We also recommend that you label the cables with waterproof tags for future reference.

CAUTION

Before you connect cables to the fish finder, or disconnect cables, the fish finder power and equipment power sources must be turned off.

NOTE

If you have questions about the installation or troubleshooting, see your fish finder installation guide. Also, contact Humminbird Technical Support at humminbird.johnsonoutdoors.com.

SET UP OR CHANGE TRANSDUCER SETTINGS

(ADVANCED SETTINGS)

When you connect a transducer to a black box sonar or to the Humminbird fish finder, the transducer will be detected in the network automatically. The best transducer source will be chosen and start pinging automatically. If you connect an accessory transducer to the network, the unit will recognize the new transducer.

⚠ CAUTION

The instructions in this section are advanced and not recommended for the typical user. Changing these settings incorrectly could damage the transducer.

NOTES

For sonar networking information, see **Set up your Humminbird Network**. Also, to set up an Airmar transducer, or for troubleshooting information, download the **Transducer Setup Guide** from our Web site at humminbird.johnsonoutdoors.com.

Humminbird has provided the best settings for your unit. You can use the settings included with your fish finder, or you can adjust these advanced options.

Change Transducer Sources

Use the instructions in this section to turn on and off transducers.

1. Press the HOME key.
2. Select Settings.
3. Select Sonar.
4. Select Sonar Source.
5. Tap the on/off button, or press the ENTER key, to turn it on/off.

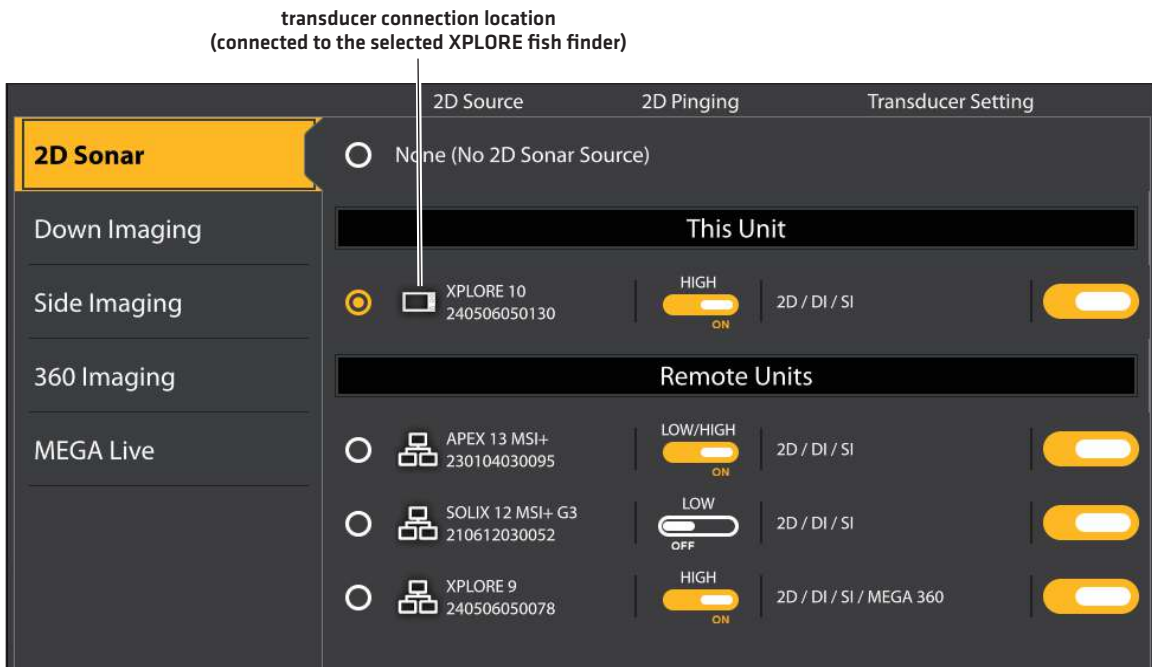

Set up or Change Transducer Settings (not recommended)

Use the instructions in this section to disable auto-configure for a transducer.

1. Press the HOME key.
2. Select Settings.
3. Select Sonar.
4. Select Transducer Setup.

5. Select Auto-Configure.

6. Tap the on/off button, or press the ENTER key, to turn it on/off.

7. **Sonar Capabilities:** With Auto-Configure turned off, add a check mark next to each sonar capability.

For example, for a 2D transducer, the 2D Sonar menu needs to be checked. For a Side Imaging transducer, 2D Sonar, SI Sonar, and DI Sonar need to be checked because the transducer includes all three capabilities.

NOTE

The capabilities of your sonar model are shown on the packaging, or you can find your transducer on our Web site at humminbird.johnsonoutdoors.com.

8. **Frequencies:** Select the Frequency Capability Menu under each checked sonar capability. Select an individual frequency.

9. **Temp:** If the transducer includes a temperature probe, add a check mark to Temp.

10. **Max Depth (optional):** When Max Depth is set to Auto, the maximum depth is determined by the transducer frequency, and the fish finder will acquire bottom readings as needed [within the capacity of the unit]. Auto is the recommended setting for this menu.

To manually set the Max Depth, select MAN [Manual], and adjust the slider to the maximum depth setting. The transducer will not attempt to acquire sonar data below that depth, so more detail will be shown on the sonar view.

11. **Depth Offset (optional):** Depth Offset adjusts the digital depth readout to indicate the distance from the transducer to the waterline.

NOTES

Make sure all capabilities have a check mark so the full functionality of the transducer is enabled. To select sonar sources from the network, see [Set up your Humminbird Network](#).

The menu options are determined by the connected transducer.

Transducer Setup

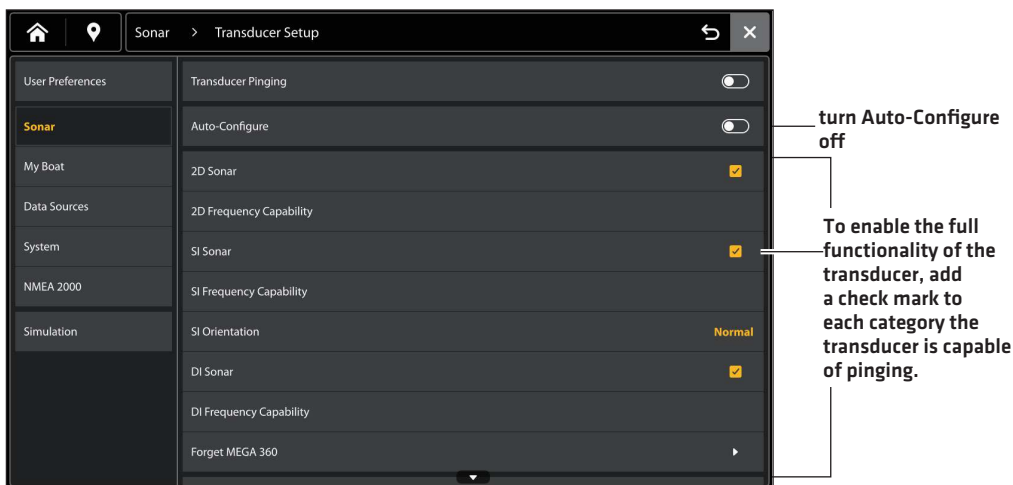

Change the Water Type

Use the instructions in this section to change the Water Type setting.

1. Press the HOME key.
2. Select Settings.
3. Select Sonar.
4. Select Water Type.
5. Select Fresh Water, Salt Water [200 ft [61 m] or deeper], or Salt Water Shallow [20 ft [6.1 m] or less]. Tap the item or use the Cursor pad/Joystick to make your selection.

Adjust the Noise Filter (not recommended)

Use Noise Filter to limit the interference that may appear on the sonar views from sources such as your boat engine, turbulence, or other sonar devices.

1. Press the HOME key.
2. Select Settings.
3. Select Sonar.
4. Select Noise Filter.
5. Tap the on/off button, or press the ENTER key, to turn it on.
6. Tap the +/- icons, or press the +/- ZOOM keys, to adjust the setting.

Change the Side Imaging Orientation (MEGA SI models only)

Use SI Orientation to switch how the Side Imaging beams are displayed on the Side Imaging View. This menu option can be used if the port and starboard beams are reversed during installation, which might be the case if a transducer is installed incorrectly. For further assistance, contact Humminbird Technical Support.

1. Press the HOME key.
2. Select Settings.
3. Select Sonar.
4. Select Transducer Setup.
5. Turn Auto-Configure off.
6. Select SI Orientation.
7. **To display the beams as the transducer[s] is installed**, select Normal.
To change how the beams are displayed so that port and starboard are switched, select Reverse.

Turn on SI Background Pinging

Use the instructions in this section to turn on SI Background Pinging. This will enable SI to ping even when the view is not displayed.

1. Press the HOME key.
2. Select Settings.
3. Select Sonar.
4. Select SI Background Pinging.
5. Tap the on/off button, or press the ENTER key, to turn it on.

CONFIGURE THE FISH FINDER

Use the instructions in this section to review fish finder and network connections and name the fish finders and networks.

System Info

Review System Connections

Use the System Info dialog box to review fish finder information such as the software version and serial number. You can also review connection information for the equipment connected to the fish finder ports, and you can change the fish finder name.

1. Press the HOME key.
2. Select Settings.
3. Select System.
4. Select System Info.

System Info

Total Time: 35 h **X**

Model:	XPLORE 10	Serial Number:	240506050123	fish finder information
Unit Name:	240506050123	IP Address:		
Software Version:	5.028 (10/04/24 10:15)	MAC Address:	18:00:CE:76:A5:B6	network name
Network Name:	NET:240506050123			
Internal GPS:	Not Connected			ports and connection information
NMEA 2000:	Not Connected			
Transducer:	Not Configured			
MEGA 360 Imaging:	V0.000 S/N: 00000000-0000			
MEGA Live Imaging:	V1.234 S/N: 200206170001			
MEGA Live 2 Imaging:	V2.468 S/N: 202406170001			
Sonar Temp:	Not Connected			
Sonar Temp::	Not Connected			

Rename Unit

Depth	Voltage	Position	Time/Date
43.4 ft	13.7 V	N 34.37446° W 86.27414°	9:07:49 AM 11/8/2022

rename the fish finder

Change the Fish Finder Name

When a fish finder is part of a network, you can change its name so it is easy to identify as a source on the network.

1. From the System Info dialog box (above), select Rename Unit. Use the on-screen keyboard to change the fish finder name.
2. Select Save.

When equipment is connected to the fish finder, the equipment and its data will be detected automatically. You can also manually select data, set the data offset, baud rate, and NMEA output sentences from the Sensor Port sub-menus. The available menus are determined by the attached equipment.

1. Press the HOME key.
2. Select Settings.
3. Select System.
4. Select Rear Connectors.
5. Select GPS / NMEA 0183.

If you've connected an external GPS or an external GPS/Heading Sensor or a NMEA 0183 device to the fish finder, use the following menu options to select the Sensor Type, Data Offset, Baud Rate, and NMEA 0183 Output.

Sensor Type	<p>Auto-Select is turned on as the default setting, and the available data from the attached sensor will be auto-selected with a check mark.</p> <p>To change the selected data, turn off Auto-Select, and manually change the data by adding or removing a check mark. [check mark = selected]</p>
Data Offset	<p>To adjust the zero point of the attached sensor, select Data Offsets. Depending on the attached sensor, you can adjust the Depth Offset, Temperature Offset, Heading Adjustment, and STW [Speed Through Water] Calibration from this menu.</p> <p>For example, select Depth Offset to adjust the digital depth readout to indicate the depth from the waterline or the boat's keel for the selected sensor.</p>
Baud Rate	<p>Select a baud rate for the selected port. [Auto, 4800, 9600, 38400; Default = Auto]</p>
NMEA 0183 Output	<p>Select NMEA Output sentences for the selected port. See the NMEA 0183 table on the following pages.</p>

NOTE

To set up a NMEA 2000 network, see **Set up a NMEA 2000 Network**.

NMEA 0183

Message	Description	Input	Output
AAM	Waypoint Arrival Alarm		•
APB	Heading/Track Controller [Autopilot] Sentence "B"		•
BOD	Bearing-Origin to Destination		•
BWC	Bearing & Distance to Waypoint - Great Circle		•
BWR	Bearing & Distance to Waypoint - Rhumb Line		•
DBT	Depth Below Transducer	•	•
DPT	Depth	•	•
GGA	Global Positioning System Fix Data	•	•
GLL	Geographical Position - Latitude/Longitude	•	•
GNS	GNSS Fix Data	•	•
GSA	GNSS DOP and Active Satellites	•	•
GSV	GNSS Satellites In View	•	•
HDG	Heading, Deviation & Variation	•	•
HDM	Heading, Magnetic	•	•
HDT	Heading, True	•	
MTW	Water Temperature	•	•
MWD	Wind Direction & Speed	•	
MWV	Wind Speed & Angle	•	
RMB	Recommended Minimum Navigation Information		•
RMC	Recommended Minimum Specification GNSS Data	•	•
ROT	Rate of Turn	•	•
VBW	Dual Ground/Water Speed	•	
VDM	AIS VHD Data Link [Other Vessels]	•	
VDO	AIS VHD Data Link [Own Vessel]	•	
VHW	Water Speed and Heading	•	•
VTG	Track Made Good & Ground Speed		•
XDR	Transducer Measurements	•	
XTE	Cross-Track Error, Measured		•
ZDA	Time & Date	•	•

Configure the NMEA Talker ID

Use the following instructions to change the NMEA 0183 Talker ID to match the NMEA 0183 installed accessory.

1. Press the HOME key.
2. Select Settings.
3. Select System > Rear Connectors > GPS / NMEA 0183.
4. Select NMEA 0183 Output.
5. Under Configure NMEA Talker ID, select IN-Integrated Navigation [Default] or GP-Global Positioning System.

SET UP A NMEA 2000 NETWORK

Use the instructions in this section if a NMEA 2000 network is connected to the fish finder.

When equipment is connected to the fish finder, the equipment and its data will be detected automatically. You can also manually select equipment. The available menus are determined by the attached equipment.

NOTE

Humminbird recommends that the NMEA 2000 network be installed by a certified NMEA 2000 technician. See NMEA.org for details.

Turn on the NMEA 2000 Network

1. Press the HOME key.
2. Select Settings.
3. Select NMEA 2000.
4. Select NMEA 2000 Network.
5. Tap the on/off button, or press the ENTER key, to turn it on/off.

Select NMEA 2000 Devices Manually (optional)

When equipment is connected to the fish finder, the equipment and its data will be detected automatically. Use the instructions in this section to manually select devices to use on the NMEA 2000 network. See the illustrations on the following pages.

1. Press the HOME key.
2. Select Settings.
3. Select NMEA 2000.
4. Select NMEA 2000 Devices.
5. Select Auto-Select. Tap the on/off button, or press the ENTER key, to turn it off.
6. Select devices to add to the NMEA 2000 network. [check mark = included, blank = not included]

NMEA 2000 Network Devices Selected Manually

The screenshot shows the 'NMEA 2000 Devices' settings page. The 'Auto-Select' toggle is turned off. Under the 'This Unit' section, two devices are listed with their respective checkboxes checked, indicating they are manually selected.

Device Name	Selected
CORTEX SW: v1.08.1469 SN:A20026F7	<input checked="" type="checkbox"/>
AS GPS HS N2K SW: v1.205 SN:240723380004	<input checked="" type="checkbox"/>

Annotations: 'turn off Auto-Select' points to the 'Auto-Select' toggle. 'selected device' points to the checked checkboxes of the two devices.

NMEA 2000 Network Devices Selected Automatically

The screenshot shows the 'NMEA 2000 Devices' settings page with 'Auto-Select' turned on. A list of seven simulator devices is shown, all with their checkboxes checked, indicating they were automatically selected.

Device Name	Selected
NMEA2000 simulator GPS SW: v1.17.1.312 SN:2097151	<input checked="" type="checkbox"/>
NMEA2000 simulator Log SW: v1.17.1.312 SN:2097150	<input checked="" type="checkbox"/>
NMEA2000 simulator fluid level SW: v1.17.1.312 SN:2097146	<input checked="" type="checkbox"/>
NMEA2000 simulator Wind meter SW: v1.17.1.312 SN:2097149	<input checked="" type="checkbox"/>
NMEA2000 simulator engine SW: v1.17.1.312 SN:2097147	<input checked="" type="checkbox"/>
NMEA2000 simulator outside envir SW: v1.17.1.312 SN:2097148	<input checked="" type="checkbox"/>

Annotations: 'turn on Auto-Select' points to the 'Auto-Select' toggle. 'devices detected and selected on the NMEA 2000 network' points to the checked checkboxes of the simulator devices.

NMEA 2000 Messages (PGN)

The following NMEA 2000 input/output messages are available when NMEA 2000 is turned on and the related NMEA 2000 equipment is detected and selected as a source.

Message (PGN)	Description	Input	Output
059392	ISO Acknowledgment	▪	▪
059904	ISO Request	▪	▪
060928	ISO Address Claim	▪	▪
126208	Group Function	▪	▪
126464	Receive/Transmit PGN List	▪	▪
126992	System Time	▪	▪
126996	Product Information	▪	▪
127245	Rudder	▪	
127250	Vessel Heading	▪	▪
127251	Rate of Turn	▪	
127257	Attitude	▪	
127258	Magnetic Variation	▪	
127488	Engine Parameters, Rapid Update	▪	
127489	Engine Parameters - Dynamic	▪	
127496	Trip Parameters Vessel	▪	
127497	Trip Parameters Engine	▪	
127500	Load Controller Connection State	▪	
127501	Binary Status Report	▪	
127502	Switch Bank Command	▪	
127505	Fluid Level	▪	
127506	DC Detail Status	▪	
127508	Battery Status	▪	
127513	Battery Configuration Status	▪	
128259	Speed Water Referenced	▪	
128267	Water Depth	▪	
129025	Position Rapid Update	▪	▪
129026	COG & SOG, Rapid Update	▪	▪
129029	GNSS Position Data	▪	▪
129033	Time & Date	▪	▪
129044	Datum	▪	
129283	Cross Track Error	▪	
129284	Navigation Data	▪	▪
129285	Navigation - Route/WP Information	▪	
129539	GNSS DOPs	▪	
129540	GNSS Sats in View	▪	

Message (PGN)	Description	Input	Output
130052	Loran C TD Data	▪	
130306	Wind Data	▪	
130310	Environmental Parameters	▪	
130311	Environmental Parameters	▪	
130312	Temperature	▪	
130313	Humidity	▪	
130314	Actual Pressure	▪	
130323	Meteorological Station Data	▪	
130569	Entertainment Current File Status		▪
130570	Entertainment Library Data File	▪	▪
130571	Entertainment Library Data Group	▪	▪
130572	Entertainment Library Data Search	▪	▪
130573	Entertainment Supported Source Data	▪	
130574	Entertainment Supported Zone Data	▪	
130576	Small Craft Status	▪	
130577	Direction Data	▪	
130579	Entertainment System Config Status	▪	
130581	Entertainment Zone Config Status	▪	
130582	Entertainment Zone Volume Status	▪	▪
130584	Entertainment Bluetooth Devices	▪	▪
130585	Entertainment BT Source Status	▪	

NMEA 2000 AIS Messages (PGN)

The following NMEA 2000 input/output messages are available when NMEA 2000 is turned on and an AIS is detected and selected as a source on the NMEA 2000 network.

Message (PGN)	Description	Input	Output
129038	Class A Position Report	▪	
129039	Class B Position Report	▪	
129041	AIS A to N Position Report	▪	
129793	AIS UTC and Date Report	▪	
129794	AIS Static and Voyage Report A	▪	
129798	AIS SAR Aircraft Position	▪	
129802	AIS Broadcast Safety Message	▪	
129809	AIS Class B Static Data, Part A	▪	
129810	AIS Class B Static Data, Part B	▪	

Set up NMEA 2000 Engine Sources

When a NMEA 2000 Engine is connected to the NMEA 2000 network, it is detected by the fish finder. The fish finder will provide prompts to set up engines in the system. The fish finder assigns a number to each engine. The sources are numbered lowest to highest, where 0 [zero] is the lowest and first source identified. You can use the sources identified by the fish finder, or you can manually assign an engine to each source number.

For example, Engine 1 reports data from the engine identified as the number 0 Instance in installation [typically the engine located on the port side of the boat towards the bow], and Engine 2 is the engine identified as the number 1 instance in installation [typically the engine located on the starboard side of the boat towards the keel].

NOTE

See *Views: Set up an Instrument View* to set up the instrument views for your engine data.

Set up the Number of Engines

The number of engines and tanks are entered using the Setup Guide during initial installation. Use the instructions in this section to change the number of engines and tanks displayed on the fish finder.

1. Press the HOME key.
2. Select Settings.
3. Select My Boat.
4. Select Engines/Tanks.
5. Select the total number of engines and fuel tanks on your boat.

Engine/Tank Setup

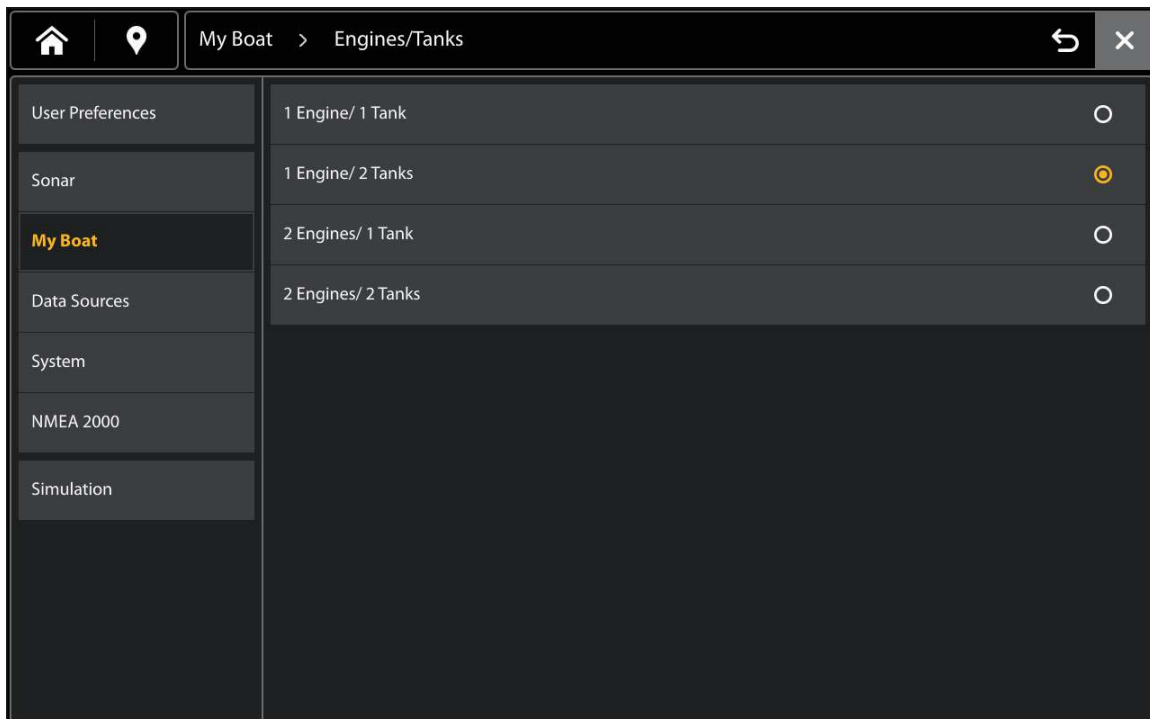

Change the Engine Source Assignments

The instructions in this section are optional and allow you to change which engine is assigned as the Engine 1 or Engine 2 source in the fish finder.

1. Press the HOME key.
2. Select Settings.
3. Select Data Sources.
4. Under Engine Data, select Engine 1 or Engine 2.
5. Turn off Auto-Configure.
6. Select an Engine from the list.

Engine 1 Source Auto-Configured

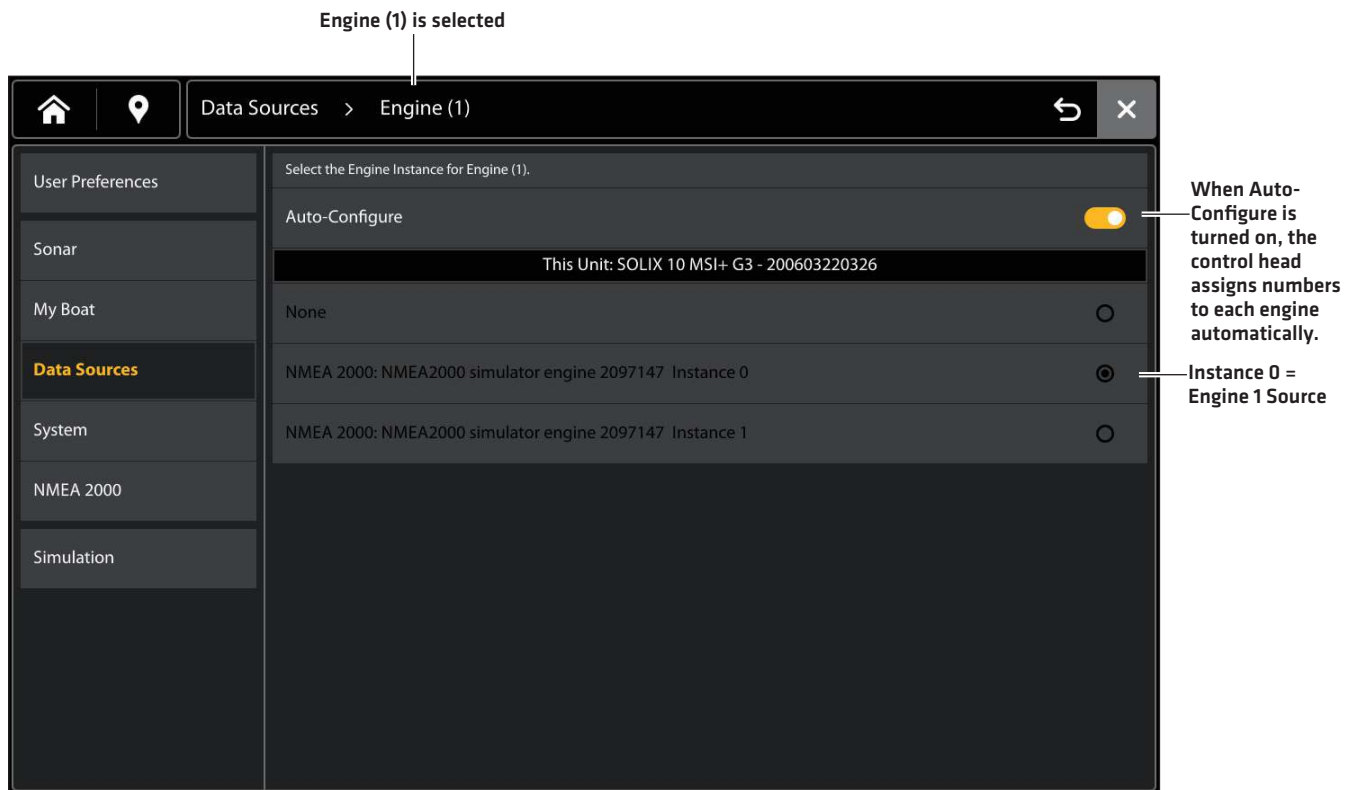

Set up Fuel Tanks

The Setup Guide provides prompts to set up the fuel tanks in the system, and it assigns a source number to each fuel tank. If a NMEA 2000 fuel tank sensor and a fuel flow rate sensor are installed, the fish finder can display fuel levels automatically. If only a fuel flow rate sensor is installed, you need to set up the fuel tanks manually to manage fuel levels.

Set up the Number of Tanks

The number of engines and tanks are entered using the Setup Guide during initial installation. Use the instructions in this section to change the number of engines and tanks displayed on the fish finder.

1. Press the HOME key.
2. Select Settings.
3. Select My Boat.
4. Select Engines/Tanks.
5. Select the total number of engines and fuel tanks on your boat.

If you do not have a NMEA 2000 fuel tank sensor, proceed to **Set the Fuel Tank Capacity**.

Set the Fuel Tank Capacity

If there is a fuel flow rate sensor installed, but not a NMEA 2000 fuel tank sensor, use the instructions in this section to set up fuel tank data manually. You can also use these instructions to confirm Automatic Fuel Management Mode if you have a NMEA 2000 fuel tank sensor and a fuel flow rate sensor installed.

1. Set up the number of fuel tanks on the boat. See **Set up the Number of Tanks**.
2. Press the HOME key.
3. Select the Fuel tool.
4. Select Settings.
5. Select Manual.

NOTE

If NMEA 2000 fuel tank sensor and a fuel flow rate sensor are installed, select Auto to automatically detect the tank capacity.

6. Select Fuel Capacity.
7. Use the on-screen keyboard to enter the total fuel capacity of the tank.
If there is more than one tank on the boat, indicate the total amount of fuel from all tanks.
8. Select Save.

Setting up Fuel Tanks Manually

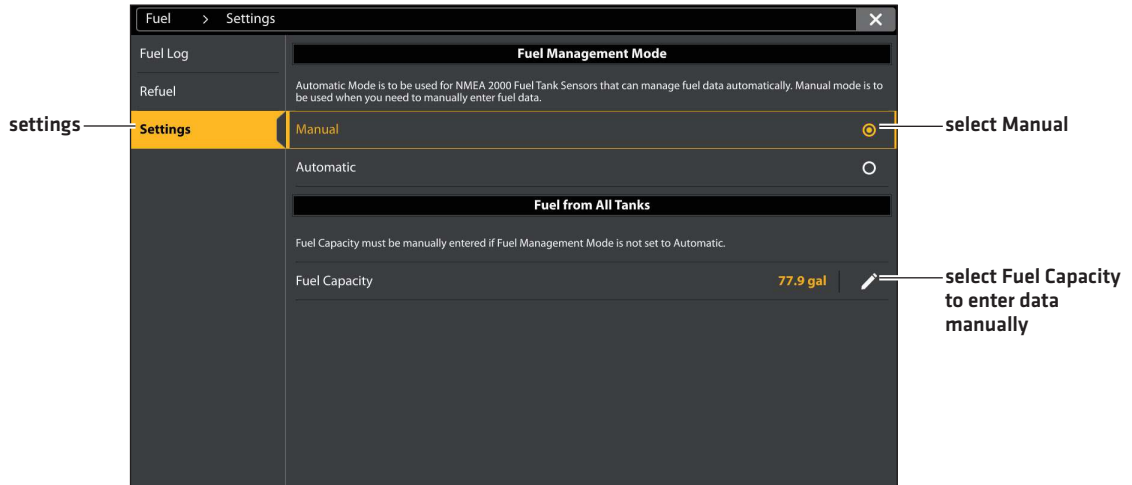

Open the Fuel Tool

1. Press the HOME key.
2. Select Tools.
3. Select the Fuel tool.

Displaying the Fuel Tool

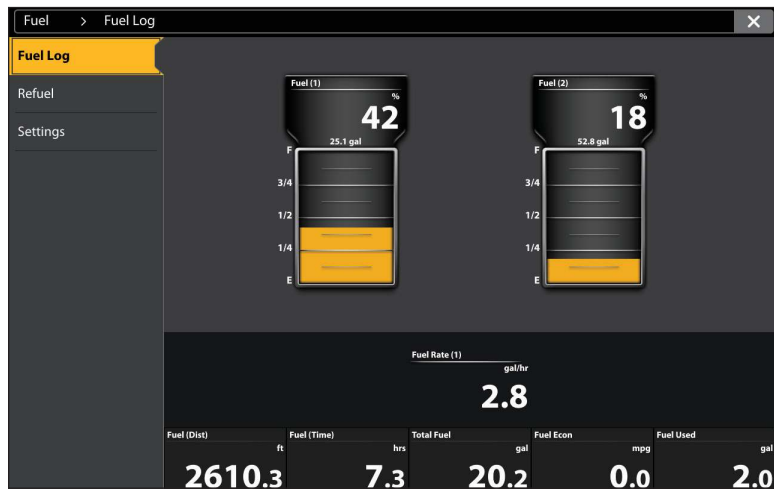

Refill the Tank(s)

The menu options in this section are determined by the Fuel Management Mode [Manual or Automatic]. See *Set the Fuel Tank Capacity* for more information.

1. Open the Fuel tool, and select Refuel.
2. **To fill the tank to the top**, select Fill Up or Reset Fuel Used.

To add an amount to the tank, select Add Fuel. Use the on-screen keyboard to enter the amount and save it.

Change the Fuel Tank or Fuel Flow Source Assignments

The instructions in this section are optional and allow you to change which fuel tank is assigned as the Tank 1 or Tank 2 source in the fish finder. You can also use these instructions to change the fuel flow rate Sensors (Fuel Flow) assignments. The menu options are determined by the type of sensors installed.

1. Press the HOME key.
2. Select Settings.
3. Select Data Sources.
4. Under Fuel Data, select Tank 1 or Tank 2.
If fuel flow rate sensors are installed, select Fuel Flow - Engine 1 or 2.
5. Turn off Auto-Configure.
6. Select a fuel tank from the list.

SET UP YOUR HUMMINBIRD NETWORK

When the Humminbird network is fully installed and everything is connected on the same switch, the network will be auto-configured so the fish finders and equipment are synchronized across the network. Depending on your network configuration, your options may include sources from remote fish finder[s], NMEA 0183, Ethernet, and NMEA 2000.

NOTE

All fish finders must be on the same software version to be connected to the network.

Use the instructions in this section to complete the following network setup requirements:

1. Configure a new network.
2. Select transducers from the network.
3. Change GPS sources.
4. Select data sources.
5. Set vessel display settings.

1 | View Network

Use the instructions in this section to view the Humminbird fish finders connected to the network. The network synchronizes the fish finder settings.

1. Press the HOME key.
2. Select Settings.
3. Select System.
4. Select Network Info.

2 | Select Sonar Sources

When a transducer is first connected to the fish finder or network, it will be detected by all fish finders in the network. The fish finder selects the transducer connected to it as the primary sonar source. See humminbird.johnsonoutdoors.com for transducer configuration options.

NOTE

Humminbird has provided the best setting for your unit. You can use the settings included with your fish finder, or you can adjust these advanced options.

Open the Sonar Source Menu

1. Press the HOME key.
2. Select Settings.
3. Select Sonar.
4. Select Sonar Source.

Sonar Source Overview

When the network is configured, you can select any transducer from the network to provide the sonar data on the fish finder. The sonar sources can be shared between fish finders or you can use individual sonar sources on each fish finder.

The transducer you select on the 2D Sonar tab will provide the data for the 2D Sonar Views and related digital readouts.

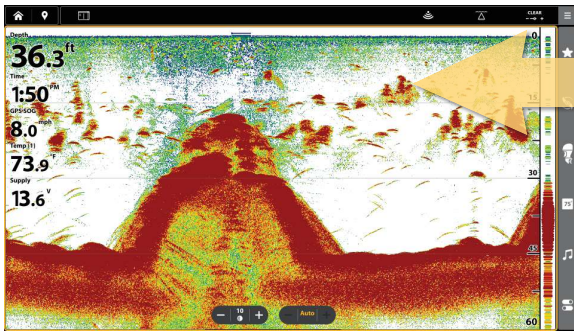

The Sonar Source Select menu with the 2D Sonar tab selected. The 2D Source is set to 'None (No 2D Sonar Source)'. Under 'This Unit', the XPLORE 10 transducer is selected with 'HIGH' ping and 'ON' status. Under 'Remote Units', the APEX 13 MSI+ is selected with 'LOW/HIGH' ping and 'ON' status.

The transducer you select on the Down Imaging tab will provide the data for the Down Imaging Views and related digital readouts.

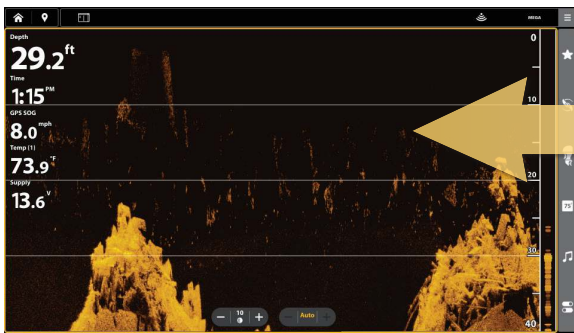

The Sonar Source Select menu with the Down Imaging tab selected. The DI Source is set to 'None (No DI Sonar Source)'. Under 'This Unit', the XPLORE 10 transducer is selected with 'CMDI+' ping and 'ON' status. Under 'Remote Units', the APEX 13 MSI+ is selected with '455/800/MEGA' ping and 'ON' status.

The transducer you select on the Side Imaging tab will provide the data for the Side Imaging Views and related digital readouts.

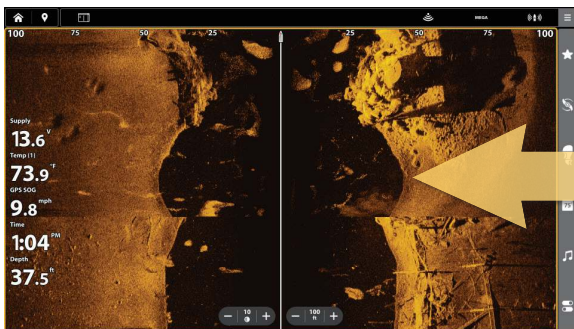

The Sonar Source Select menu with the Side Imaging tab selected. The SI Source is set to 'None (No SI Sonar Source)'. Under 'This Unit', the XPLORE 10 transducer is selected with 'CMDI+' ping and 'OFF' status. Under 'Remote Units', the APEX 13 MSI+ is selected with '455/800/MEGA' ping and 'ON' status.

Select Sonar Sources

Use the instructions in this section to assign sonar sources to each fish finder. The sonar sources can be shared between fish finders or you can use different sonar sources on each fish finder.

1. From the Sonar Source Menu, select the first tab. In the following illustration, the first tab is 2D.

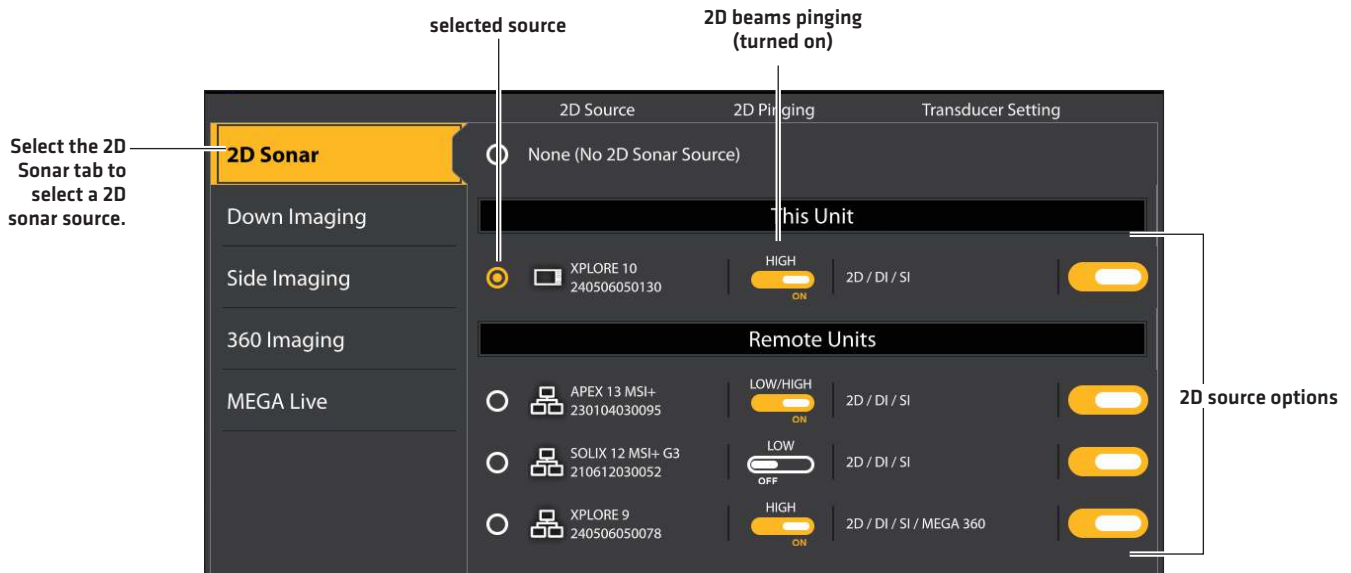

2. Select the transducer connection location. The connection locations are displayed as follows:



Selected fish finder [Local]: the fish finder you are actively using



Remote fish finder: additional fish finders connected to the network

3. Repeat steps 1 and 2 for each tab. You can select one sonar source on each tab.

NOTES

The list is determined by the connected equipment on the network and the transducer type. DualBeam PLUS sonar sources will only be displayed on the 2D tab, Down Imaging sources will only be displayed on the Down Imaging tab, etc.

If you have installed an accessory transducer, and it is not displayed in the transducer list, see **Installation Information: Set** **When you turn on/off pinging or change the transducer settings, all fish finders sharing the transducer are affected.**

3 | Select GPS Sources [optional]

The fish finder defaults to the internal GPS receiver as the primary source [GPS [1]]. If you connect an external GPS receiver to an APEX or SOLIX fish finder, it will be assigned as the primary source GPS [1]. If the fish finder is part of an Ethernet or NMEA 2000 network, you can also select the GPS receivers from the network.

GPS [1] provides position data, Speed over Ground (SOG), Course over Ground (COG), waypoints, routes, tracks, and navigation calculations to the fish finder.

GPS [2] provides position data that is displayed in the GPS [2] data box.

You can also manually change which GPS receiver is the selected source for GPS [1] or GPS [2]. For example, if you've connected an external GPS receiver to the fish finder, it will automatically be assigned as GPS [1], but you can assign it to GPS [2]. This can be changed from the GPS Tool or from the Data Sources menu in Settings.

Open the GPS Tool

1. Press the HOME key.
2. Select Tools.
3. Select the GPS tool.

Select GPS Sources Automatically

1. Under GPS Source, select GPS [1] or GPS [2].
2. Select Auto-Configure. Tap the on/off button, or press the ENTER key, to turn it on.

Select GPS Sources Manually

Use the instructions in this section to manually select a GPS source.

1. Under GPS Source, select GPS [1] or GPS [2].
2. Select Auto-Configure. Tap the on/off button, or press the ENTER key, to turn it off.
3. Select a GPS receiver from the list.

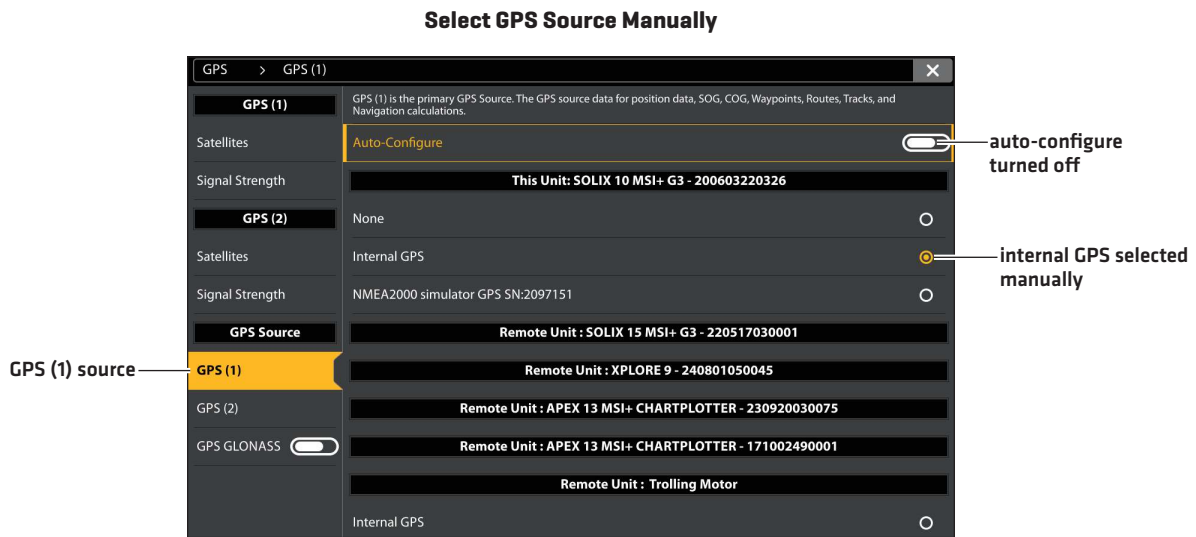

4 | Select Data Sources (optional)

When the network has been configured, you can choose sources from the entire network. Depending on your network configuration, your options may include sources from remote control head(s), NMEA 0183, Ethernet, and NMEA 2000. Sources are shared across the network. In some situations, sources can be individualized for each fish finder. For example, Fish Finder A can use one transducer and Fish Finder B can use a different transducer.

Auto-Configure: The Auto-Configure on/off button is displayed in each source category. When Auto-Configure is turned on, the sources are selected automatically by the fish finder. When Auto-Configure is turned off, you can select sources based on your preferences.

For example, if there are multiple heading sensors attached, the fish finder network will choose one sensor to provide the heading. If you prefer a different sensor to provide the heading, you can manually assign a different heading sensor as the selected source.

Select Sources Automatically (default)

Auto-Configure is turned on by default, so the instructions in this section are only necessary if you've manually changed the source selection and want to return to a source being chosen automatically.

1. Press the HOME key.
2. Select Settings.
3. Select Data Sources.
4. Select a Data Category, and select the data type under that category.
5. Select Auto-Configure. Tap the on/off button, or press the ENTER key, to turn it on.

Select Sources Manually (optional)

Use the instructions in this section to manually select a source.

1. Press the HOME key.
2. Select Settings.
3. Select Data Sources.
4. Select a Data Category, and select the data type under that category.
5. Select Auto-Configure. Tap the on/off button, or press the ENTER key, to turn it off.
6. Select a source from the list.

Manually Selecting a Source for Temp [1]

Temp (1) is selected

The screenshot shows the 'Data Sources' configuration screen for 'Temp (1)'. The left sidebar contains menu items: User Preferences, Sonar, My Boat, Data Sources (highlighted), System, NMEA 2000, and Simulation. The main content area shows a list of data sources with their respective units and a selection radio button. The 'NMEA 2000: NMEA2000 simulator outside envir 2097148' source is selected, indicated by a yellow dot. A yellow arrow points from the 'Temp (1) is selected' text to the 'Temp (1)' header. Another yellow arrow points from the 'selected source assigned to Temp (1)' label to the selected radio button.

Temp (1) data is used for Temp Overlay data, Temperature readings in Sonar applications, Waypoint data, and Track data.

Auto-Configure

This Unit: SOLIX 10 MSI+ G3 - 200603220326

None

NMEA 2000: NMEA2000 simulator outside envir 2097148

Remote Unit : MEGA Live - 210121010067

MEGA Live: MEGA Live Transducer 210121010067

information about the selected source

When Auto-Configure is turned off, you can manually select a source.

selected source assigned to Temp (1)

The sources you select will provide the data for the related digital readouts and more, depending on your selection. In the illustration above, see *Information about the Selected Source*.

The screenshot shows the main dashboard with a sonar display in the background. On the left, digital readouts are displayed: Depth 41.6 ft, Time 1:07 PM, GPS SOG 8.9 mph, Temp (1) 73.9 °F, and Supply 13.6 V. On the right, a vertical panel shows various readouts: Depth 41.6 ft, Temp (1) 73.9 °F, GPS SOG 8.4 mph, GPS COG 80 °M, Hdg 80 °M, Position - GPS 1 (N 34.37291°, W 86.27673°), and XTE. A yellow arrow points from the 'Temp (1) is selected' text in the first image to the 'Temp (1) 73.9 °F' readout in this image.

Depth 41.6 ft

Time 1:07 PM

GPS SOG 8.9 mph

Temp (1) 73.9 °F

Supply 13.6 V

Depth 41.6 ft

Temp (1) 73.9 °F

GPS SOG 8.4 mph

GPS COG 80 °M

Hdg 80 °M

Position - GPS 1
N 34.37291°
W 86.27673°

XTE

The Temp 1 digital readout data is provided by the Temp (1) source.

MANAGE YOUR FISH FINDER

Many of the fish finder settings can be accessed from the Settings tool [User Preferences] or from the Power X-Press Menu.

Open the Settings Tool

1. Press the HOME key.
2. Select Settings.
3. Select User Preferences.

Open the Power X-Press Menu

Many of the fish finder settings can be accessed quickly from the Power X-Press Menu. You can also turn off Radar transmission or change the transducer source from this menu.

1. Press the POWER key.

Adjust Lighting

The lighting menus can be accessed from the Power X-Press Menu.

Adjust the Backlight

1. Open the Power X-Press Menu.
2. Select Backlight.
3. Tap the +/- buttons, or use the Cursor pad/Joystick and +/- ZOOM keys, to adjust the setting.

Turn on/off Night Mode

1. Open the Power X-Press Menu.
2. Select Night Mode.
3. Tap the on/off button, or press the ENTER key.

Change Key Sounds

Turn on/off Key Sounds

1. Press the HOME key.
2. Select Settings.
3. Select User Preferences.
4. Select Key Sounds.
5. Tap the on/off button, or press the ENTER key.

SPECIFICATIONS

The following sections contain the product specifications for the XPLORE, APEX and SOLIX G3 fish finder and the [included] transducer. The sections are divided between XPLORE models, APEX models and G3 [third generation] SOLIX models.

For additional information about your product and/or transducers, visit our Web site at humminbird.johnsonoutdoors.com.

XPLORE Compact MEGA SI+

Control Head

XPLORE 9 Display Size [diagonal]	9.0 inches [228.6 mm]
XPLORE 10 Display Size [diagonal]	10.1 inches [256.54 mm]
XPLORE 12 Display Size [diagonal]	12.1 inches [307.34 mm]
Pixel Matrix	XPLORE 9: HD 1280 x 720 XPLORE 10 and 12: WXGA 1280 x 800
Display Type	TFT Color
Backlight	LED
Communication	Bluetooth, NMEA 2000 Bus [LEN = 2], Dual Ethernet, WiFi
Power Input	10-20 VDC
Current Draw	XPLORE 9: 2.2 Amps XPLORE 10: 2.2 Amps XPLORE 12: 2.4 Amps
Recommended Fuse	5 Amps [slow blow or MDL equivalent]
IPX Rating	IPX7 Waterproof/Submersible @ 1 m for 30 minutes and dust tight

CHIRP Compact MEGA SI + Transducer [included]

XM 14 HW CMSI T [includes built-in temperature probe]

Power Output [MAX]	500 Watts [RMS], 4000 Watts [Peak to Peak]
--------------------	--

MEGA Side Imaging+

Operating Frequency	455 kHz, MEGA Imaging+
Range Capability	455 kHz: 405 - 505 kHz, 800 ft [244 m] Side to Side MEGA Imaging+: 1.100-1.200 MHz, 400 ft [122 m] Side to Side
Area of Coverage	455 kHz [2] 75 @ -10 dB MEGA Imaging+: [2] 75 @ -10 dB

MEGA Down Imaging+

Operating Frequency 455 kHz, MEGA Imaging+

Depth Capability **455 kHz:** 420 - 520 kHz, 400 ft [122 m]
MEGA Imaging+: 1.125-1.225 MHz, 200 ft [61 m]

Area of Coverage **455 kHz:** 75° @ -10 dB
..... **MEGA Imaging+:** 70° @ -10 dB

2D CHIRP

Default Operating Frequency **Dual Spectrum CHIRP:** 150 kHz - 220 kHz

Optional Operating Frequency 200 kHz, 83 kHz, and 50 kHz
High CHIRP, Medium CHIRP, Low CHIRP

Depth Capability 1200 ft [365 m]

Area of Coverage **Full:** 25° - 42°@-10 dB in 150 - 220 kHz
Wide: 42°@-10 dB in 140 - 200 kHz
Narrow: 25°@-10 dB in 180 - 240 kHz

Power Output [MAX] 500 Watts [RMS], 4000 Watts [Peak to Peak]

NOTES

Humminbird verifies maximum stated depth in saltwater conditions, but actual depth performance may vary due to transducer installation, water type, thermal layers, bottom composition, and slope.

Product specifications and features are subject to change without notice.

XPLORE 9 Control Head Measurements

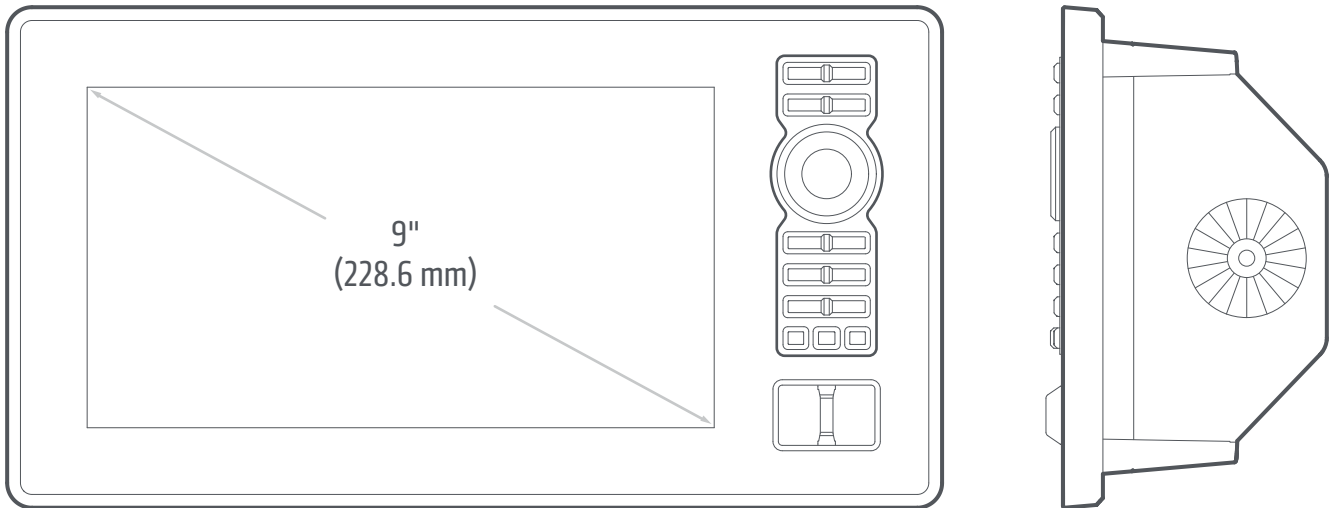

XPLORE 9 In-Dash Mount

Width	11.69" [297 mm]
Height	6.26" [159 mm]
Depth	3.3" [84 mm]

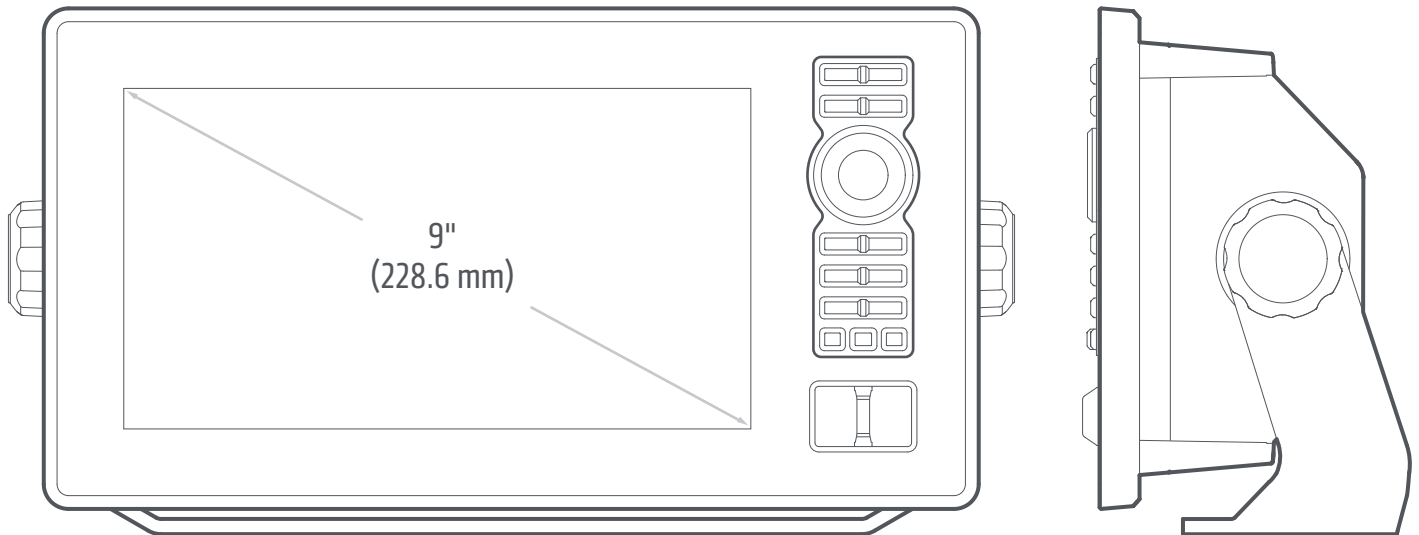

XPLORE 9 Gimbal Mount

Width	11.69" [297 mm]
Height	6.57" [167 mm]
Depth	3.88" [99 mm]

XPLORE 10 Control Head Measurements

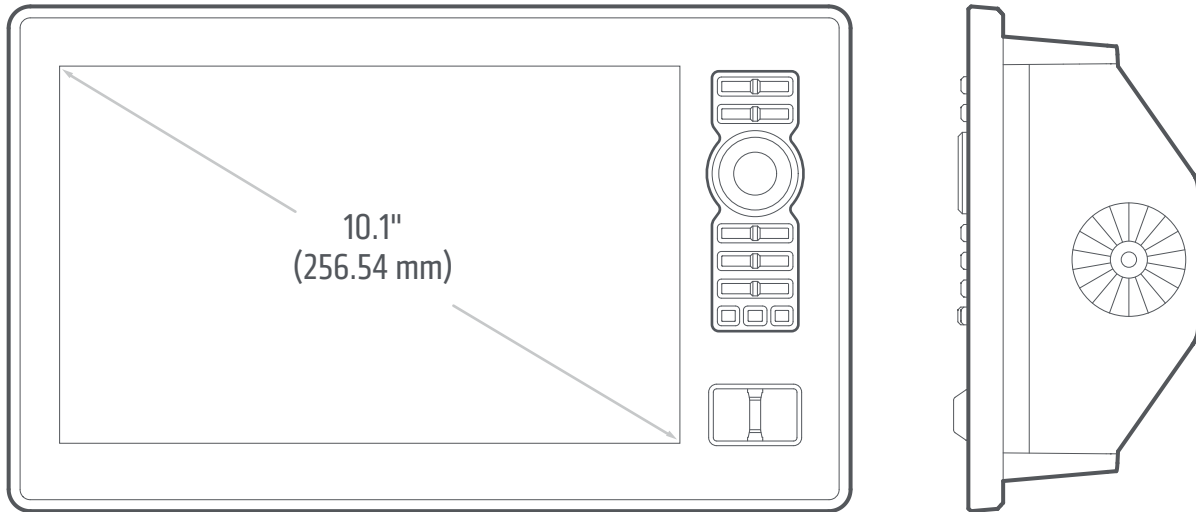

XPLORE 10 In-Dash Mount

Width	12.01" [305 mm]
Height	7.25" [184 mm]
Depth	3.3" [84 mm]

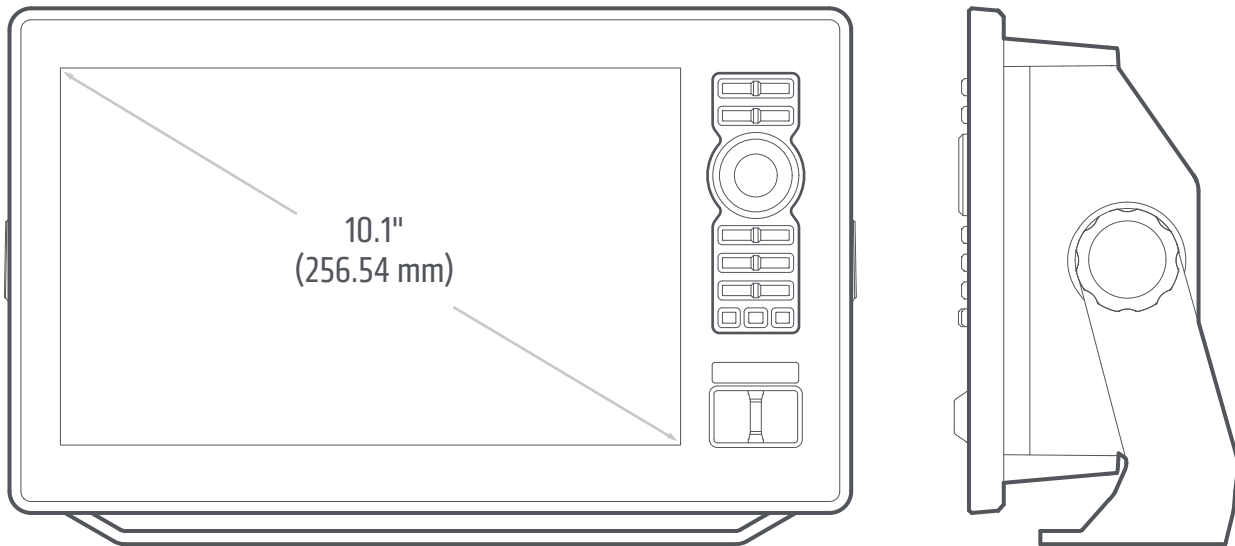

XPLORE 10 Gimbal Mount

Width	12.1" [305 mm]
Height	7.70" [196 mm]
Depth	3.89" [99 mm]

XPLORE 12 Control Head Measurements

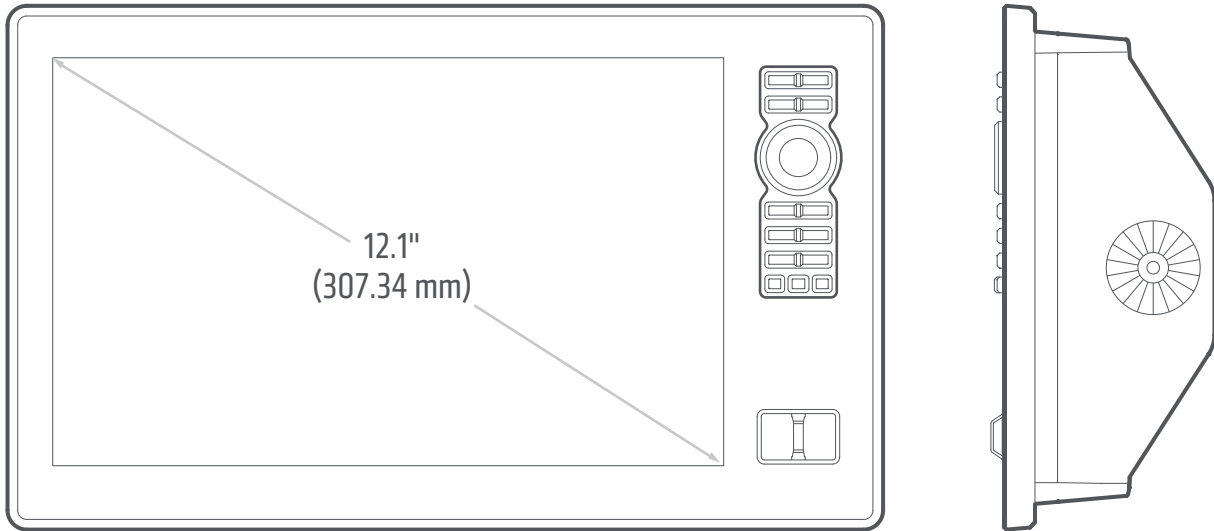

XPLORE 12 In-Dash Mount

Width	14.15" [359 mm]
Height	8.46" [215 mm]
Depth	3.4" [86 mm]

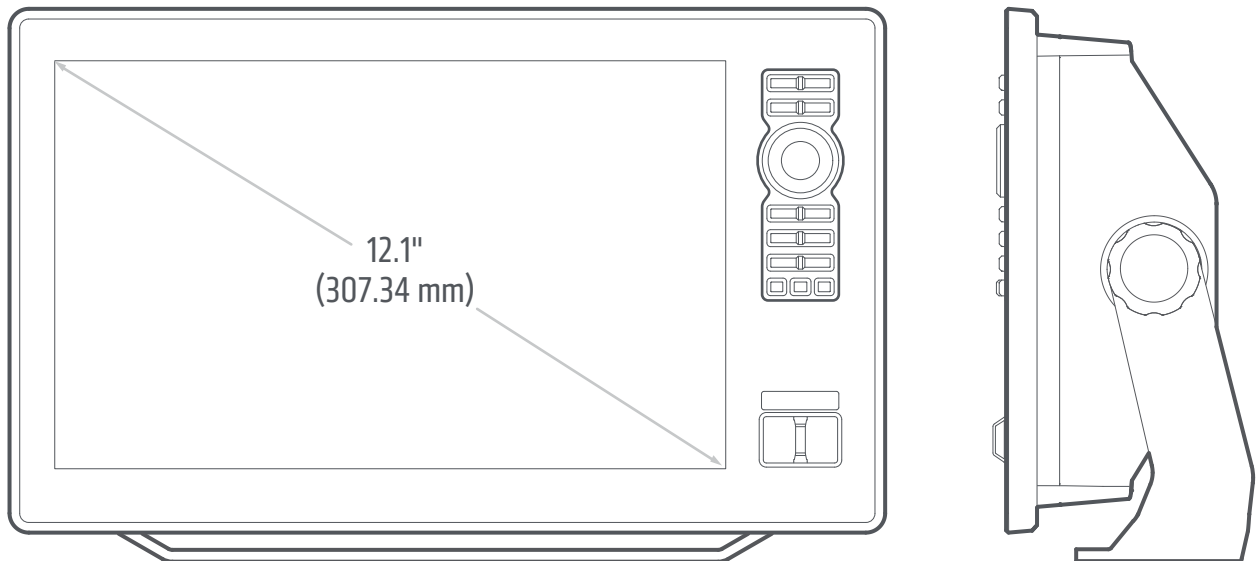

XPLORE 12 Gimbal Mount

Width	14.15" [359 mm]
Height	8.91" [226 mm]
Depth	3.99" [101 mm]

Control Head

APEX 13 Display Size [diagonal].....	13.3 inches [337.82 mm]
APEX 16 Display Size [diagonal].....	15.6 inches [396.24 mm]
APEX 19 Display Size [diagonal].....	18.5 inches [469.9 mm]
Pixel Matrix	FHD 1920 x 1080
Display Type	TFT Color
Backlight	LED
Communication	Bluetooth, NMEA 0183 Bus, NMEA 2000 Bus [LEN = 2], Dual Ethernet, WiFi
Power Requirement	12 VDC
Current Draw	APEX 13: 3.3 Amps APEX 16: 4.4 Amps APEX 19: 4.5 Amps
Recommended Fuse	APEX 13: 5 Amps [slow blow or MDL equivalent] APEX 16: 7.5 Amps [slow blow or MDL equivalent] APEX 19: 7.5 Amps [slow blow or MDL equivalent]
IPX Rating	IPX7 Waterproof/Submersible @ 1 m for 30 minutes and dust tight

Port 1: 2D, DI, SI, 360**CHIRP MEGA SI + Transducer [included]**

XM 14 HW MSI T [includes built-in temperature probe]

Power Output [MAX].....	500 Watts [RMS], 4000 Watts [Peak to Peak]
-------------------------	--

MEGA Side Imaging+

Operating Frequency	455 kHz, 800 kHz, MEGA Imaging+
Range Capability	455 kHz: 405 - 505 kHz, 800 ft [244 m] Side to Side 800 kHz: 780 - 840 kHz, 250 ft [76 m] Side to Side MEGA Imaging+: 1050 - 1175 kHz, 500 ft [152 m] Side to Side
Area of Coverage	455 kHz: [2] 86° @ -10 dB [180° Total Coverage] 800 kHz: [2] 55° @ -10 dB [130° Total Coverage] MEGA Imaging+: [2] 86° @ -10 dB [180° Total Coverage]

MEGA Down Imaging+

Operating Frequency	455 kHz, 800 kHz, MEGA Imaging+
Depth Capability	455 kHz: 435 - 535 kHz, 400 ft [122 m] 800 kHz: 800 - 860 kHz, 125 ft [38 m] MEGA Imaging+: 1100 - 1200 kHz, 250 ft [76 m]
Area of Coverage	455 kHz: 75° @ -10 dB 800 kHz: 45° @ -10 dB MEGA Imaging+: 75° @ -10 dB

2D CHIRP

Default Operating Frequency **Dual Spectrum CHIRP:** 150 kHz - 220 kHz

Optional Operating Frequency 200 kHz, 83 kHz, and 50 kHz
High CHIRP, Medium CHIRP, Low CHIRP

Depth Capability 1200 ft [365 m]

Area of Coverage **Full:** 25° - 42°@-10 dB in 150 - 220 kHz
Wide: 42°@-10 dB in 140 - 200 kHz
Narrow: 25°@-10 dB in 180 - 240 kHz

Power Output [MAX] 500 Watts [RMS], 4000 Watts [Peak to Peak]

Port 2: 2kW 2D

2D CHIRP

Optional Operating Frequency 200 kHz, 83 kHz, and 50 kHz
High CHIRP, Medium CHIRP, Low CHIRP

Depth Capability 1200 ft [365 m] / 5,000 ft [1,524 m]*

Power Output [MAX] 2,000 Watts [RMS]

*Optional Airmar CHIRP SM3000 required for extreme deep water use.

NOTES

Humminbird verifies maximum stated depth in saltwater conditions, but actual depth performance may vary due to transducer installation, water type, thermal layers, bottom composition, and slope.

Product specifications and features are subject to change without notice.

APEX 13 Control Head Measurements

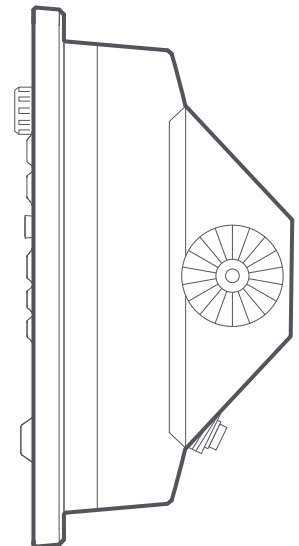
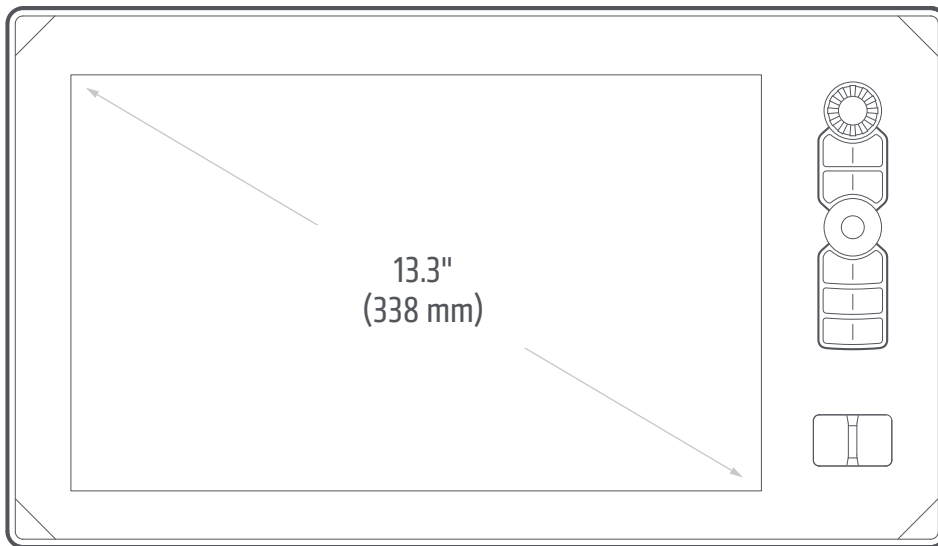

APEX 13 In-Dash Mount

Width	15.6" [396 mm]
Height	8.96" [227 mm]
Depth	5.67" [144 mm]

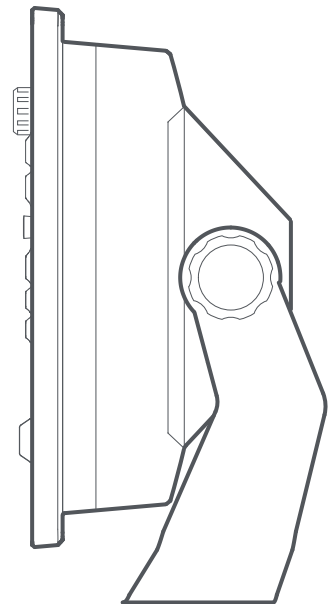
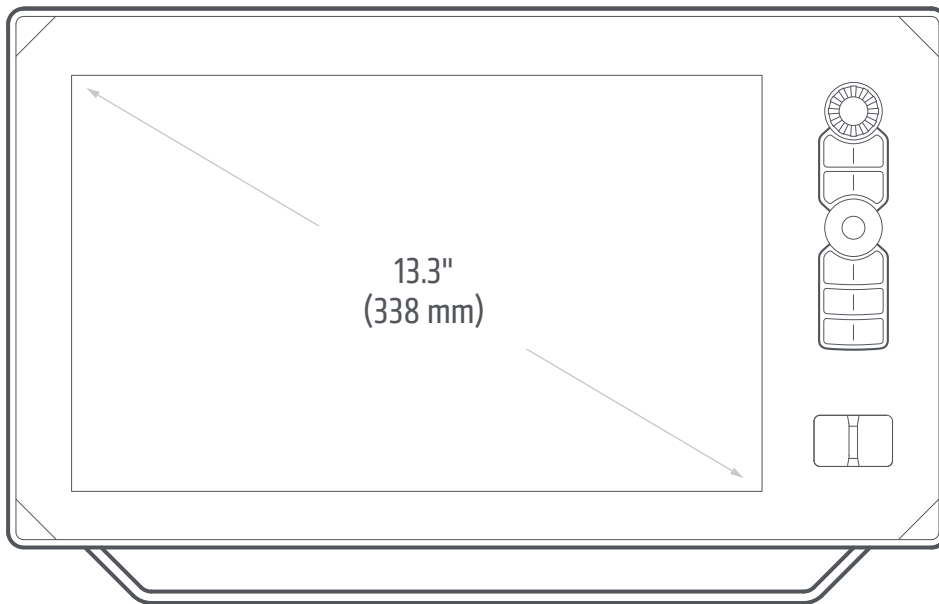

APEX 13 Gimbal Mount

Width	15.6" [396 mm]
Height	9.88" [251 mm]
Depth	4.88" [124 mm]

APEX 16 Control Head Measurements

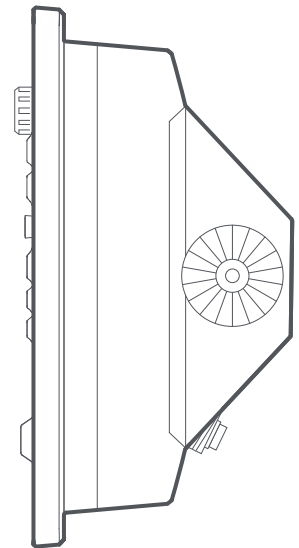
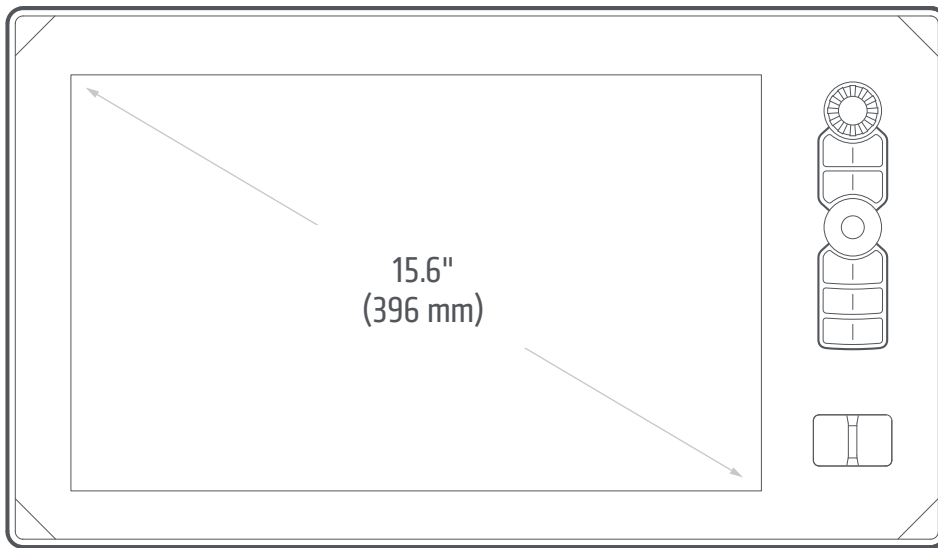

APEX 16 In-Dash Mount

Width	17.65" [448 mm]
Height	10.13" [257 mm]
Depth	5.48" [139 mm]

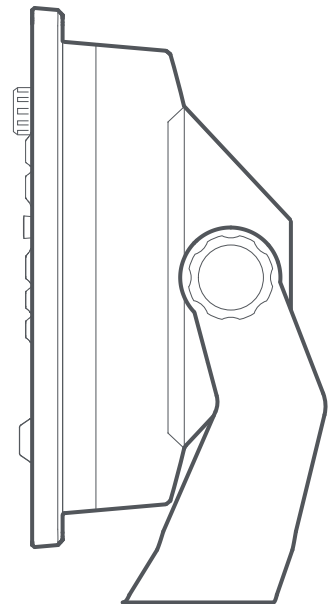
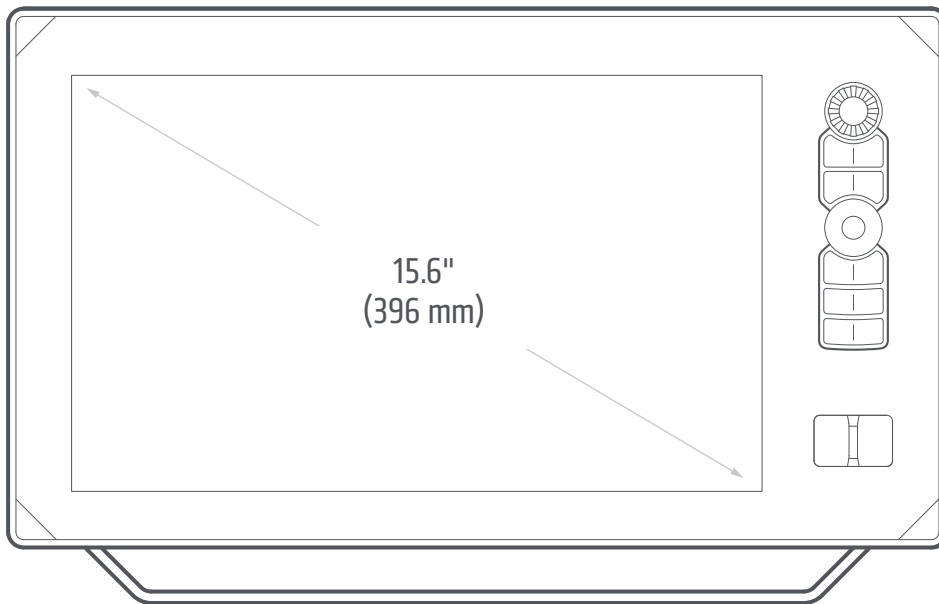

APEX 16 Gimbal Mount

Width	17.65" [448 mm]
Height	11.05" [281 mm]
Depth	4.93" [125 mm]

APEX 19 Control Head Measurements

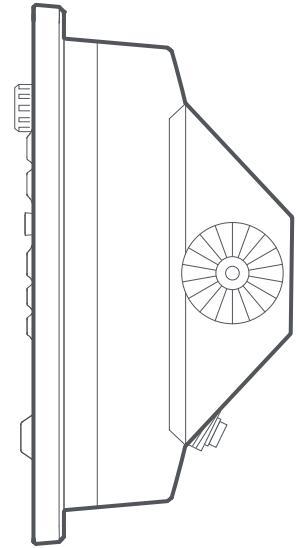
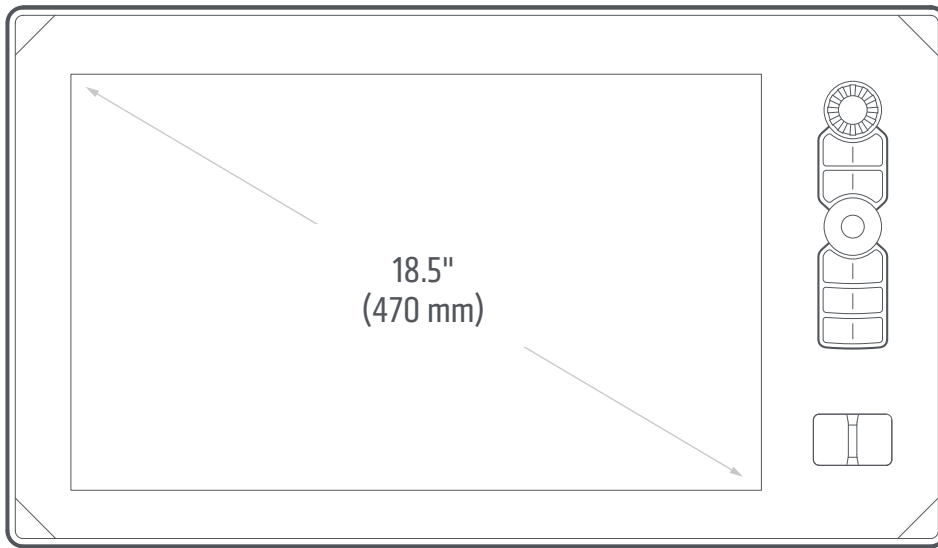

APEX 19 In-Dash Mount

Width	20.27" [515 mm]
Height	11.66" [296 mm]
Depth	5.33" [135 mm]

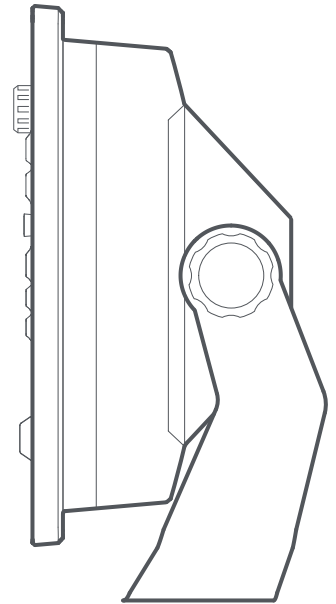
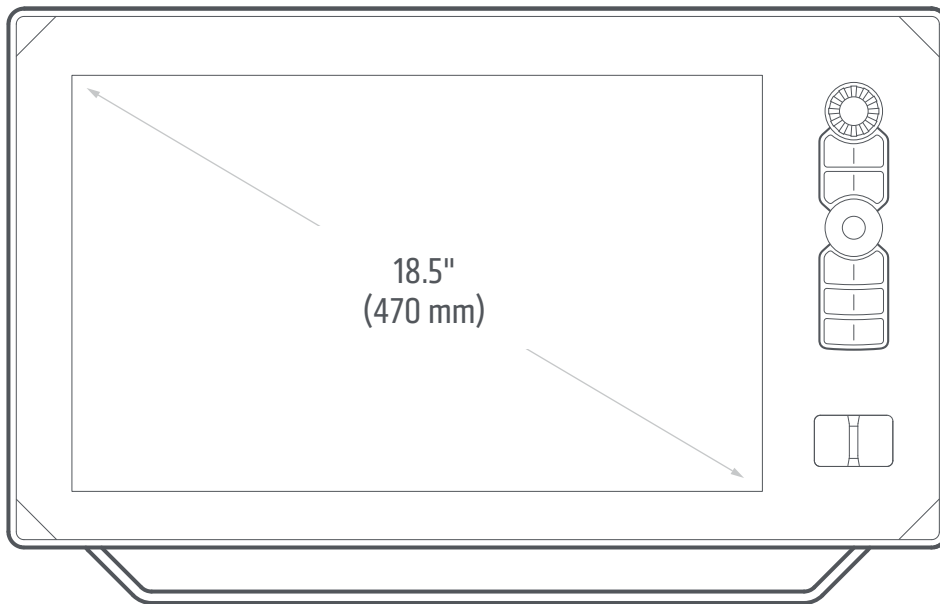

APEX 19 Gimbal Mount

Width	20.27" [515 mm]
Height	12.58" [320 mm]
Depth	4.95" [126 mm]

Control Head

SOLIX 10 Display Size [diagonal]	10.1 inches [256.54 mm]
SOLIX 12 Display Size [diagonal]	12.1 inches [307.3 mm]
SOLIX 15 Display Size [diagonal]	15.4 inches [391.16 mm]
Pixel Matrix	WXGA 1280 x 800
Display Type	TFT Color
Backlight	LED
Communication	Bluetooth, NMEA 0183 Bus, NMEA 2000 Bus [LEN = 2], Ethernet, WiFi
Power Requirement	12 VDC
Current Draw	SOLIX 10: 2.4 Amps SOLIX 12: 2.9 Amps SOLIX 15: 4 Amps
Recommended Fuse	SOLIX 10: 5 Amps [slow blow or MDL equivalent] SOLIX 12: 5 Amps [slow blow or MDL equivalent] SOLIX 15: 7.5 Amps [slow blow or MDL equivalent]
IPX Rating	IPX7 Waterproof/Submersible @ 1 m for 30 minutes and dust tight

CHIRP MEGA SI + Transducer [included]**XM 14 HW MSI T** [includes built-in temperature probe]

Power Output [MAX]	500 Watts [RMS], 4000 Watts [Peak to Peak]
--------------------------	--

MEGA Side Imaging+

Operating Frequency	455 kHz, 800 kHz, MEGA Imaging+
Range Capability	455 kHz: 404 - 505 kHz, 800 ft [244 m] Side to Side 800 kHz: 780 - 840 kHz, 250 ft [76 m] Side to Side MEGA Imaging+: 1050 - 1175 kHz, 500 ft [152 m] Side to Side
Area of Coverage	455 kHz: [2] 86° @ -10 dB [180° Total Coverage] 800 kHz: [2] 55° @ -10 dB [130° Total Coverage] MEGA Imaging+: [2] 86° @ -10 dB [180° Total Coverage]

MEGA Down Imaging+

Operating Frequency	455 kHz, 800 kHz, MEGA Imaging+
Depth Capability	455 kHz: 435 - 535 kHz, 400 ft [122 m] 800 kHz: 800 - 860 kHz, 125 ft [38 m] MEGA Imaging+: 1100 - 1200 kHz, 250 ft [76 m]
Area of Coverage	455 kHz: 75° @ -10 dB 800 kHz: 45° @ -10 dB MEGA Imaging+: 75° @ -10 dB

Dual Spectrum CHIRP

Default Operating Frequency	150 kHz - 220 kHz
Depth Capability	1200 ft (366 m)
Area of Coverage	Full: 25° - 42°@-10 dB in 150 - 220 kHz Wide: 42°@-10 dB in 140 - 200 kHz Narrow: 25°@-10 dB in 180 - 240 kHz
Power Output [MAX]	500 Watts [RMS], 4000 Watts [Peak to Peak]

NOTES

Humminbird verifies maximum stated depth in saltwater conditions, but actual depth performance may vary due to transducer installation, water type, thermal layers, bottom composition, and slope.

Product specifications and features are subject to change without notice.

Control Head

SOLIX 10 Display Size [diagonal]	10.1 inches [256.54 mm]
SOLIX 12 Display Size [diagonal]	12.1 inches [307.3 mm]
SOLIX 15 Display Size [diagonal]	15.4 inches [391.16 mm]
Pixel Matrix	WXGA 1280 x 800
Display Type	TFT Color
Backlight	LED
Communication	Bluetooth, NMEA 0183 Bus, NMEA 2000 Bus [LEN = 2], Ethernet, WiFi
Power Requirement	12 VDC
Current Draw	SOLIX 10: 2.4 Amps SOLIX 12: 2.9 Amps SOLIX 15: 4 Amps
Recommended Fuse	SOLIX 10: 5 Amps [slow blow or MDL equivalent] SOLIX 12: 5 Amps [slow blow or MDL equivalent] SOLIX 15: 7.5 Amps [slow blow or MDL equivalent]
IPX Rating	IPX7 Waterproof/Submersible @ 1 m for 30 minutes and dust tight

CHIRP MEGA Down Imaging+ Transducer [not included]

XM 14 HW MDI T [includes built-in temperature probe]

Down Imaging

Operating Frequency	455 kHz, 800 kHz, MEGA Imaging+
Depth Capability	455 kHz: 800 ft [122 m] 800 kHz: 150 ft [45.7 m] MEGA Imaging+: 250 ft [76 m]
Area of Coverage	455 kHz: 75° @ -10 dB 800 kHz: 45° @ -10 dB MEGA Imaging+: 75° @ -10 dB
Power Output [MAX]	500 Watts [RMS], 4000 Watts [Peak to Peak]

2D Sonar

Operating Frequency	200 kHz
Depth Capability	1200 ft (366 m)
Area of Coverage	20°@-10 dB in 200 kHz
Power Output (MAX).....	500 Watts (RMS), 4000 Watts (Peak to Peak)

NOTES

Humminbird verifies maximum stated depth in saltwater conditions, but actual depth performance may vary due to transducer installation, water type, thermal layers, bottom composition, and slope.

Product specifications and features are subject to change without notice.

SOLIX 10 Control Head Measurements

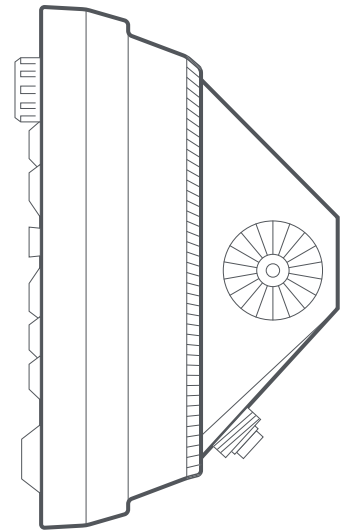
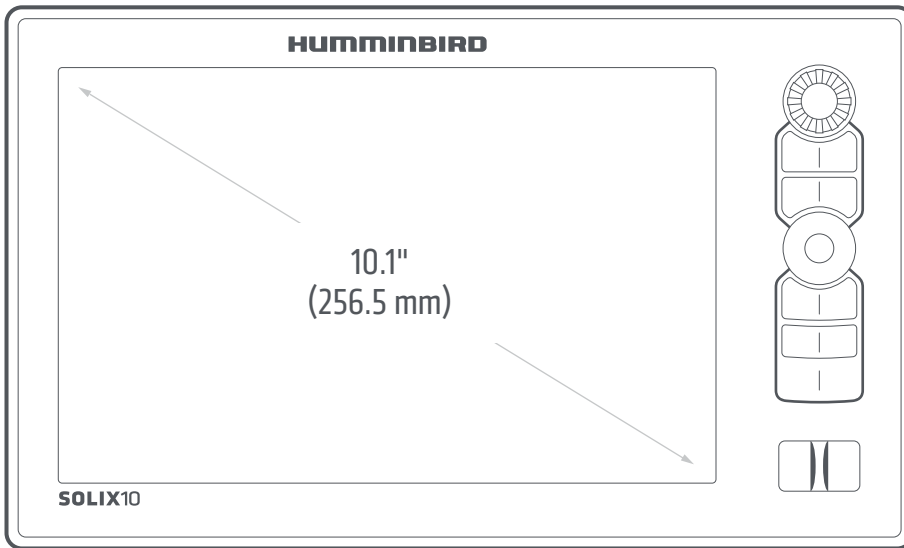

SOLIX 10 In-Dash Mount (separate purchase required)

Width	11.8" [299.7 mm]
Height	7.1" [179.3 mm]
Depth	1.2" [30.5 mm]

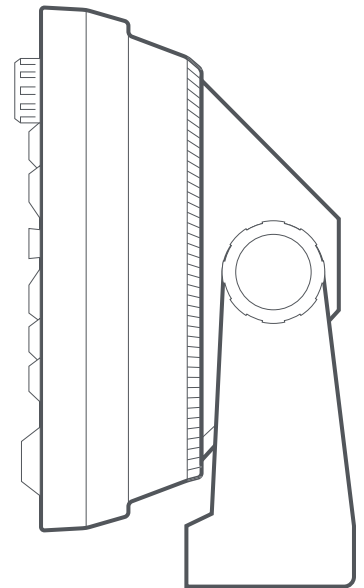
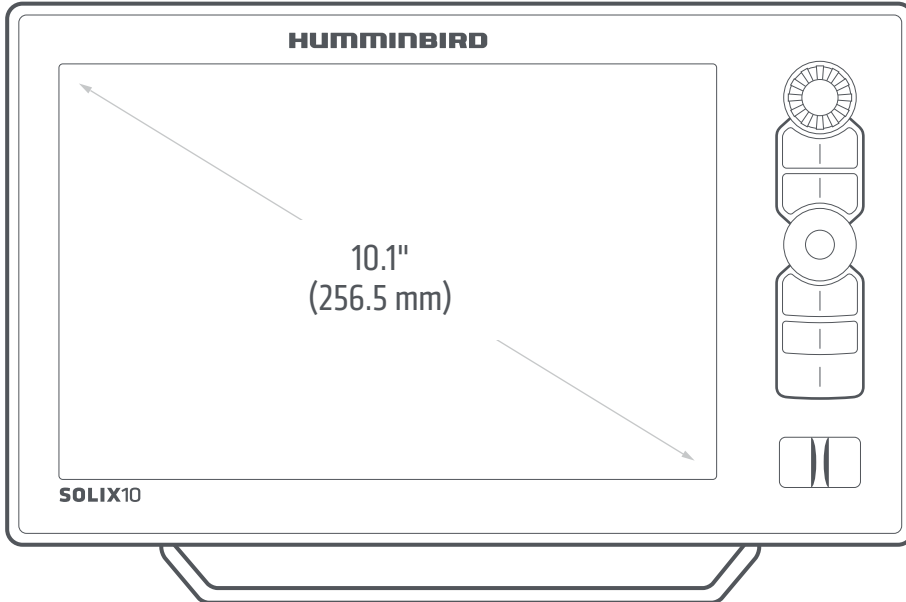

SOLIX 10 Gimbal Mount

Width	11.8" [299.7 mm]
Height	7.9" [200.4 mm]
Depth	4.8" [122 mm]

SOLIX 12 Control Head Measurements

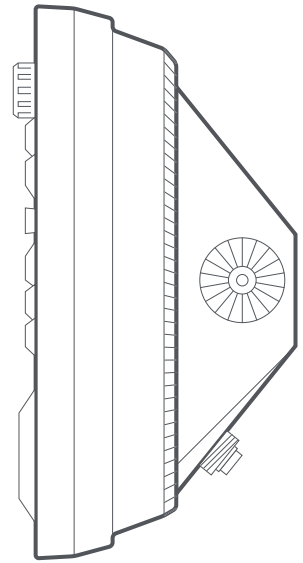
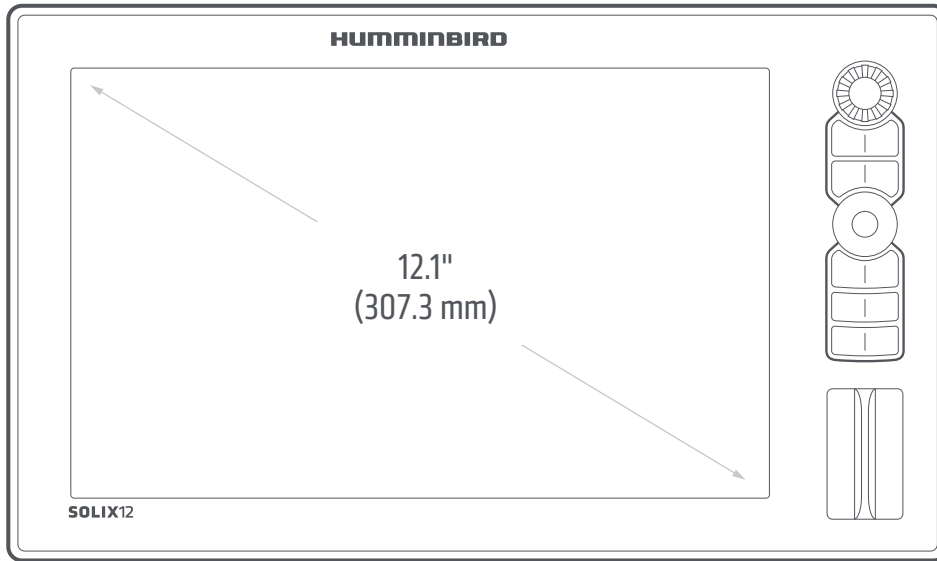

SOLIX 12 In-Dash Mount (separate purchase required)

Width	13.8" [350.5 mm]
Height	8.2" [208.5 mm]
Depth	1.2" [30.5 mm]

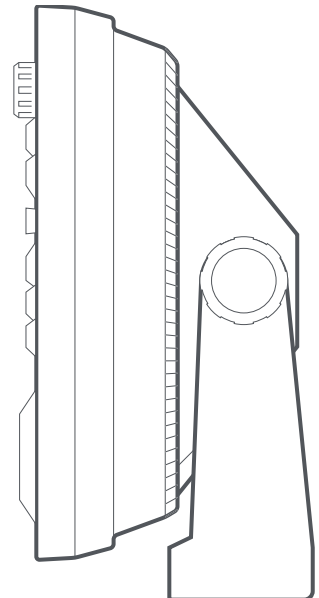
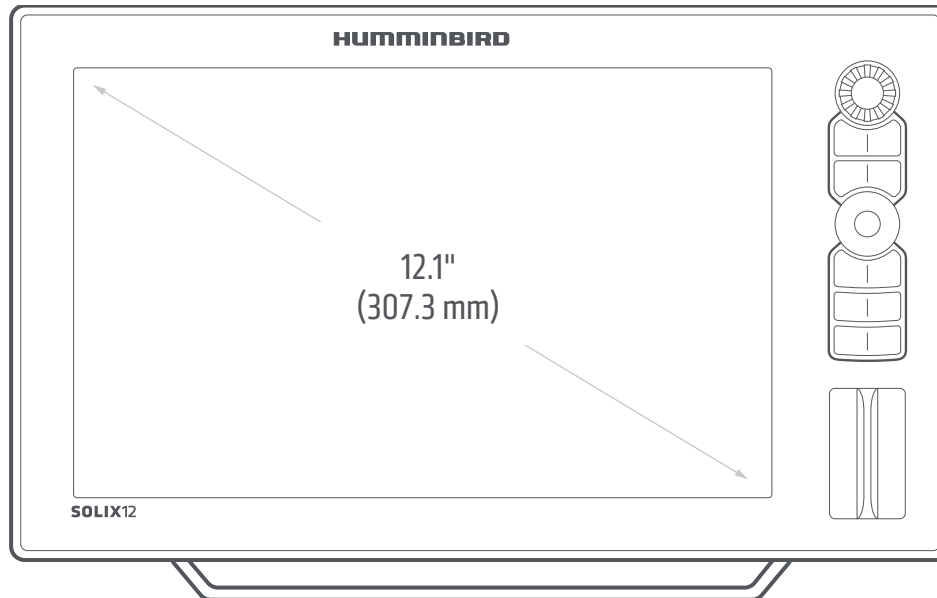

SOLIX 12 Gimbal Mount

Width	13.8" [350.5 mm]
Height	8.7" [221 mm]
Depth	4.8" [122 mm]

SOLIX 15 Control Head Measurements

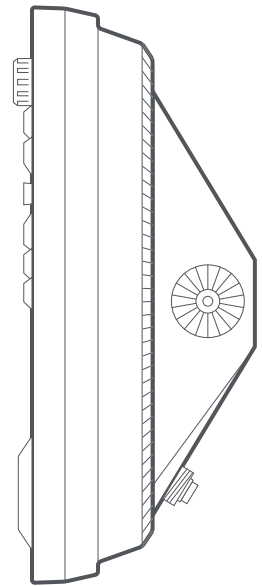
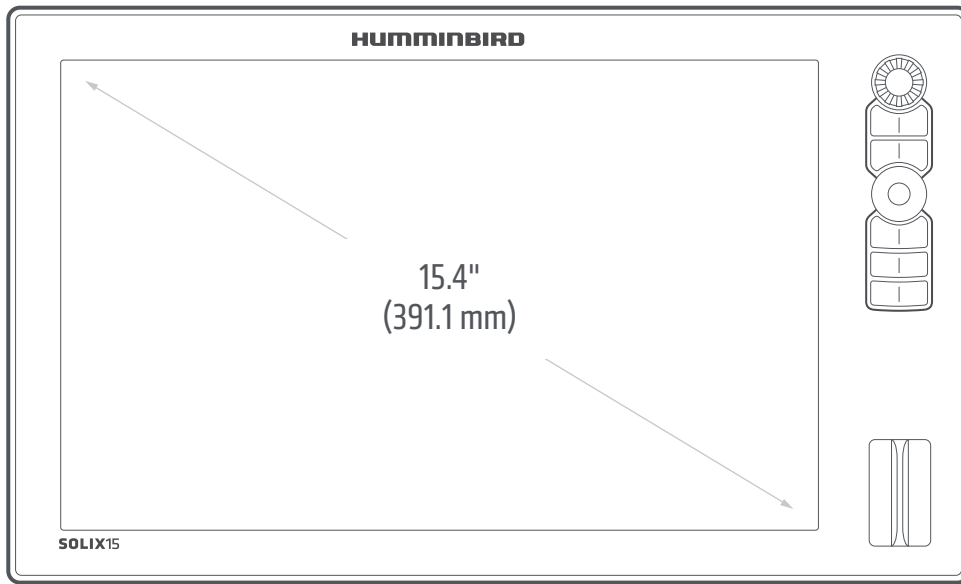

SOLIX 15 In-Dash Mount (separate purchase required)

Width	16.5" [419.9 mm]
Height	10.1" [256.5 mm]
Depth	1.2" [30.5 mm]

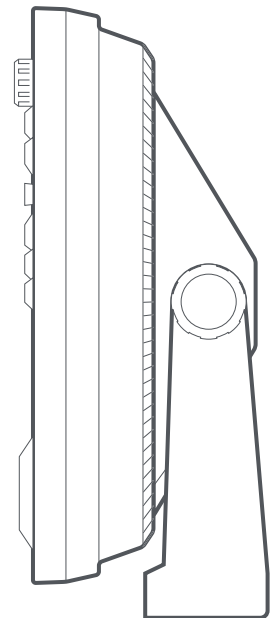
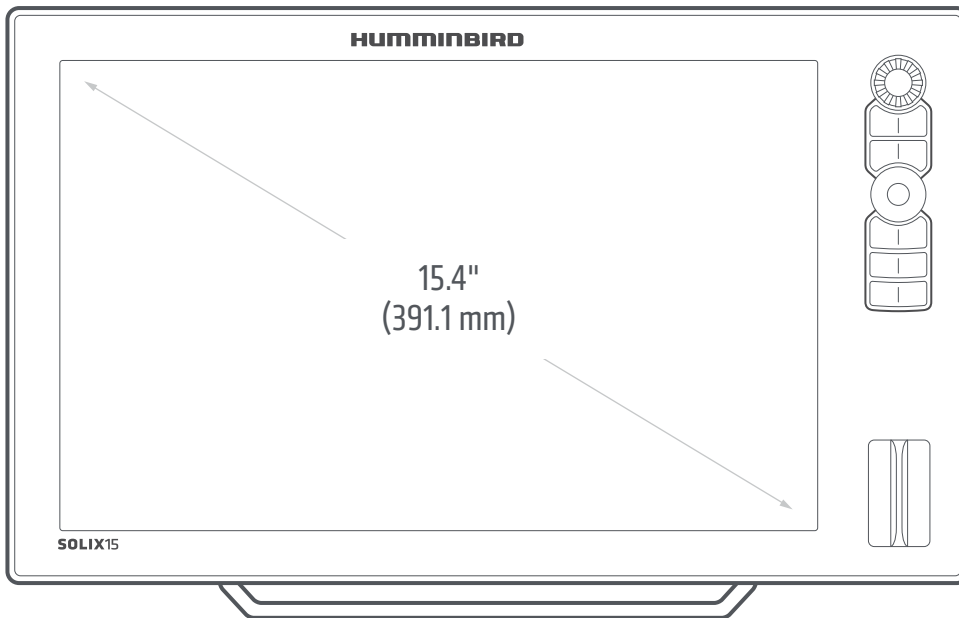

SOLIX 15 Gimbal Mount

Width	16.5" [419 mm]
Height	10.5" [266.7 mm]
Depth	4.8" [122 mm]

STATEMENTS AND ACKNOWLEDGMENTS

ENVIRONMENTAL COMPLIANCE STATEMENT: It is the intention of Johnson Outdoors Marine Electronics, Inc. to be a responsible corporate citizen, operating in compliance with known and applicable environmental regulations, and a good neighbor in the communities where we make or sell our products.

WEEE DIRECTIVE: EU Directive 2002/96/EC “Waste of Electrical and Electronic Equipment Directive [WEEE]” impacts most distributors, sellers, and manufacturers of consumer electronics in the European Union. The WEEE Directive requires the producer of consumer electronics to take responsibility for the management of waste from their products to achieve environmentally responsible disposal during the product life cycle.

WEEE compliance may not be required in your location for electrical & electronic equipment [EEE], nor may it be required for EEE designed and intended as fixed or temporary installation in transportation vehicles such as automobiles, aircraft, and boats. In some European Union member states, these vehicles are considered outside of the scope of the Directive, and EEE for those applications can be considered excluded from the WEEE Directive requirement.



This symbol [WEEE wheelie bin] on product indicates the product must not be disposed of with other household refuse. It must be disposed of and collected for recycling and recovery of waste EEE. Johnson Outdoors Marine Electronics, Inc. will mark all EEE products in accordance with the WEEE Directive. It is our goal to comply in the collection, treatment, recovery, and environmentally sound disposal of those products; however, these requirements do vary within European Union member states. For more information about where you should dispose of your waste equipment for recycling and recovery and/or your European Union member state requirements, please contact your dealer or distributor from which your product was purchased.

Caldera Systems, Inc.

The following copyright and license is applicable to the OpenSLP project:

Copyright © 2000 Caldera Systems, Inc.

All rights reserved.

Redistribution and use in source and binary forms, with or without modification, are permitted provided that the following conditions are met:

- Redistributions of source code must retain the above copyright notice, this list of conditions and the following disclaimer.
- Redistributions in binary form must reproduce the above copyright notice, this list of conditions and the following disclaimer in the documentation and/or other materials provided with the distribution.
- Neither the name of Caldera Systems nor the names of its contributors may be used to endorse or promote products derived from this software without specific prior written permission.

THIS SOFTWARE IS PROVIDED BY THE COPYRIGHT HOLDERS AND CONTRIBUTORS “AS IS” AND ANY EXPRESS OR IMPLIED WARRANTIES, INCLUDING, BUT NOT LIMITED TO, THE IMPLIED WARRANTIES OF MERCHANTABILITY AND FITNESS FOR A PARTICULAR PURPOSE ARE DISCLAIMED. IN NO EVENT SHALL THE CALDERA SYSTEMS OR CONTRIBUTORS BE LIABLE FOR ANY DIRECT, INDIRECT, INCIDENTAL, SPECIAL, EXEMPLARY, OR CONSEQUENTIAL DAMAGES (INCLUDING, BUT NOT LIMITED TO, PROCUREMENT OF SUBSTITUTE GOODS OR SERVICES; LOSS OF USE, DATA, OR PROFITS; OR BUSINESS INTERRUPTION) HOWEVER CAUSED AND ON ANY THEORY OF LIABILITY, WHETHER IN CONTRACT, STRICT LIABILITY, OR TORT (INCLUDING NEGLIGENCE OR OTHERWISE) ARISING IN ANY WAY OUT OF THE USE OF THIS SOFTWARE, EVEN IF ADVISED OF THE POSSIBILITY OF SUCH DAMAGE.

HDMI



The end user shall use HDMI compliant cable.

The terms HDMI and HDMI High-Definition Multimedia Interface, and the HDMI Logo are trademarks or registered trademarks of HDMI Licensing LLC in the United States and other countries.

NOTE

This product uses libxml++ software. This portion of the software is free software; you can redistribute it and/or modify it under the terms of the GNU Lesser General Public License as published by the Free Software Foundation; either version 2 of the License, or [at your option] any later version. This program is distributed in the hope that it will be useful, but WITHOUT ANY WARRANTY; without even the implied warranty of MERCHANTABILITY or FITNESS FOR A PARTICULAR PURPOSE. See the GNU Lesser General Public License for more details.

You may receive a copy of the GNU Lesser General Public License along with this program; if not, write to the Free Software Foundation, Inc., 51 Franklin Street, Fifth Floor, Boston, MA 02110-1301 USA.

To receive a free copy of the libxml++ software used in this system, please send a letter of request* with the following information:

Name (First & Last)
Phone Number
E-mail Address
Mailing Address
Humminbird serial number
[Your Humminbird unit must be registered at humminbird.johnsonoutdoors.com/support/productregistration.aspx.]

Shipping and Handling:

We can only accept requests that include a money order in the amount of \$9.99 to cover shipping and handling. Please allow 4-6 weeks for processing.

Send the letter of request* to the following address:

Software Request
Humminbird
678 Humminbird Lane
Eufaula, AL 36027

***NOTE:** A copy of the libxml++ software is not required to upgrade your fishing system. The Humminbird application software and control head include a separate service warranty. Please see humminbird.johnsonoutdoors.com and the separate warranty card included with your unit for details.

libxml12 (The MIT License)

Except where otherwise noted in the source code [e.g. the files hash.c, list.c and the trio files, which are covered by a similar license but with different Copyright notices] all the files are:

Copyright © 1998-2003 Daniel Veillard. All Rights Reserved.

Permission is hereby granted, free of charge, to any person obtaining a copy of this software and associated documentation files [the "Software"], to deal in the Software without restriction, including without limitation the rights to use, copy, modify, merge, publish, distribute, sublicense, and/or sell copies of the Software, and to permit persons to whom the Software is furnished to do so, subject to the following conditions:

The above copyright notice and this permission notice shall be included in all copies or substantial portions of the Software.

THE SOFTWARE IS PROVIDED "AS IS", WITHOUT WARRANTY OF ANY KIND, EXPRESS OR IMPLIED, INCLUDING BUT NOT LIMITED TO THE WARRANTIES OF MERCHANTABILITY, FITNESS FOR A PARTICULAR PURPOSE AND NONINFRINGEMENT. IN NO EVENT SHALL THE DANIEL VEILLARD BE LIABLE FOR ANY CLAIM, DAMAGES OR OTHER LIABILITY, WHETHER IN AN ACTION OF CONTRACT, TORT OR OTHERWISE, ARISING FROM, OUT OF OR IN CONNECTION WITH THE SOFTWARE OR THE USE OR OTHER DEALINGS IN THE SOFTWARE.

Except as contained in this notice, the name of Daniel Veillard shall not be used in advertising or otherwise to promote the sale, use or other dealings in this Software without prior written authorization from him.

Linux Operating System

NOTE

This product uses the Linux operating system. This portion of the software is free software; you can redistribute it and/or modify it under the terms of the GNU General Public License as published by the Free Software Foundation; either version 2 of the License, or [at your option] any later version. This program is distributed in the hope that it will be useful, but WITHOUT ANY WARRANTY; without even the implied warranty of MERCHANTABILITY or FITNESS FOR A PARTICULAR PURPOSE. See the GNU General Public License for more details.

You may receive a copy of the GNU General Public License along with this program; if not, write to the Free Software Foundation, Inc., 51 Franklin Street, Fifth Floor, Boston, MA 02110-1301 USA.

To receive a free copy of the Linux software used in this system, please send a letter of request* with the following information:

Name (First & Last)

Phone Number

E-mail Address

Mailing Address

Humminbird serial number

[Your Humminbird unit must be registered at humminbird.johnsonoutdoors.com/support/productregistration.aspx.]

Shipping and Handling:

We can only accept requests that include a money order in the amount of \$9.99 to cover shipping and handling. Please allow 4-6 weeks for processing.

Send the letter of request* to the following address:

Software Request

Humminbird

678 Humminbird Lane

Eufaula, AL 36027

***NOTE:** A copy of the Linux operating system is not required to upgrade your fishing system. The Humminbird application software and control head include a separate service warranty. Please see humminbird.johnsonoutdoors.com and the separate warranty card included with your unit for details.

Macho (C++ Machine Objects) (The MIT License)

The Machine Objects class library [in short Macho] allows the creation of state machines based on the "State" design pattern in straight C++. It extends the pattern with the option to create hierarchical state machines, making it possible to convert the popular UML statechart notation to working code in a straightforward way. Other features are entry and exit actions, state histories and state variables.

Copyright © 2005 by Eduard Hiti [feedback to reverse:de.ehiti@macho]

Permission is hereby granted, free of charge, to any person obtaining a copy of this software and associated documentation files (the "Software"), to deal in the Software without restriction, including without limitation the rights to use, copy, modify, merge, publish, distribute, sublicense, and/or sell copies of the Software, and to permit persons to whom the Software is furnished to do so, subject to the following conditions:

The above copyright notice and this permission notice shall be included in all copies or substantial portions of the Software.

THE SOFTWARE IS PROVIDED "AS IS", WITHOUT WARRANTY OF ANY KIND, EXPRESS OR IMPLIED, INCLUDING BUT NOT LIMITED TO THE WARRANTIES OF MERCHANTABILITY, FITNESS FOR A PARTICULAR PURPOSE AND NONINFRINGEMENT. IN NO EVENT SHALL THE AUTHORS OR COPYRIGHT HOLDERS BE LIABLE FOR ANY CLAIM, DAMAGES OR OTHER LIABILITY, WHETHER IN AN ACTION OF CONTRACT, TORT OR OTHERWISE, ARISING FROM, OUT OF OR IN CONNECTION WITH THE SOFTWARE OR THE USE OR OTHER DEALINGS IN THE SOFTWARE.

You are encouraged to provide any changes, extensions and corrections for this software to the author at the above-mentioned email address for inclusion into future versions.

WARNING!

The electronic chart is an aid to navigation designed to facilitate the use of authorized government charts, not to replace them. Only official government charts and notices to mariners contain all information needed for the safety of navigation, and as always, the captain is responsible for their prudent use.

ACKNOWLEDGMENT OF THIRD PARTY NOTICES AND COPYRIGHT LICENSES: This product may contain cartography and other data from one or more of the following Third Party sources; to the extent that any such source is used, the relevant provisions below shall apply:

“National Oceanic and Atmospheric Administration [NOAA]”, “National Imagery Mapping Agency [NIMA]”, “National Geospatial-Intelligence Agency [NGA]”, “National Agriculture Imagery Program [NAIP]”, “United States Army Corps of Engineers [USACE]”, “United States Geological Survey [USGS], Digital Line Graphic [DLG], Digital Raster Graphic [DRG]”, “Department of Natural Resources [DNR]”, “United States Department of Defense”, “United States Department of Commerce, Bureau of Public Roads & State’s Highway Commission”, “Department of Environmental Protection [DEP]”, “Department of Fish and Wildlife”, “Department of Game and Fishing”, “Ocean Mapping Group, Department of Geodesy and Geomatics Engineering, University of New Brunswick”, “Pennsylvania Fish and Boat Commission [PFBC]”, “Florida Natural Areas Inventory [FNAI]”, “North Carolina Wildlife Resources Commission [NCWRC]”, “New York State, Department of Environmental Conservation”, “National Geophysical Data Center & Great Lakes Environmental Research Laboratory - Great Lakes Information Network”, “Imray Charts”, “Wavey Line Charts Publishing”, “Angler Atlas”, “Fish-n-Map Company”, “Track Map Data”, “Servicio de Hidrografia Naval [SHN], Argentina”, “Western Australia Department of Planning and Infrastructure [DPIWA]”, “Australian Hydrographic Service [AHS]”, “Maritime Safety Agency of State of Queensland [MSQ]”, “@The State of Queensland [Department of the Environment and Resource Management] [DERM]”, “I-Cubed”, “GeoContent”, “DigitalGlobe”, “European Environment Agency [Corine]”, “Algemene Nederlandsche Wielestrijders Bond [ANWB]”, “@ Dutch Ministry of Infrastructure and Environment”, “Dienst Der Hydrografie, Netherlands”, “Vlaamse Hydrografie, Belgium”, “Belgium National Oceanographic Data Centre [BMDC]”, “Management Unit of the North Sea Mathematical Models [MUMM]”, “Landesvermessungsamt Baden-Wurtemberg”, “Bundesamt für Seeschifffahrt und Hydrographie [BSH]”, “Bundesministerium für Verkehr, Bau und Stadtentwicklung – Die Wasser- und Schifffahrtsverwaltung des Bundes [WSW], Germany”, “Geodatastyrelsen [GST]”, “Delius Klasing Verlag [DKV]”, “Estonian Maritime Administration [EMA]”, “Finnish Maritime Administration [FMA]”, “National Land Survey [NLS]”, “Service Hydrographique et Oceanographique de la Marine [SHOM]”, “Hellenic Navy Hydrographic Service [HNHS]”, “Hrvatski Hidrografski Institut [HHI], Croatia”, “Icelandic Coast Guard [ICG]”, “Istituto Idrografico della Marina, Italia”, “Ministero dello Sviluppo Economico, Italia”, “Japan Hydrographic Department”, “Norwegian Hydrographic Service [Statens Kartverk Interreg Geovekst]”, “Nordeca SA”, “Myosa Boating Union”, “State Hydrographic Service Ukraine [SHSU]”, “United Kingdom Hydrographic Office [UKHO], @British Crown Copyright, [2013]”, “British Oceanographic Data Centre [BODC] and the Environment Agency”, “Channel Coastal Observatory”, “IHO-IOC GEBCO Gazetteer of Undersea Feature Names, Bathymetric Contours derived from the GEBCO_08 Grid and GEBCO One Minute Grid; www.gebco.net”, “United Kingdom Department of Energy and Climate Control”, “The database of British and Irish Hills by Graham Jackson and Chris Crocker”, “Swedish Maritime Administration [SMA]”, “Hydrographica AB”, “Instituto Hidrográfico, Portugal [IHPT]”, “Instituto Hidrográfico de la Marina, España [IHM]”, “Ministerio de Agricultura, Alimentación y Medio Ambiente, España [MAGRAMA]”, “Departamento de Medio Ambiente, Planificación Territorial, Agricultura y Pesca, Gobierno Vasco”, “National Hydrographic Office, Sultanate of Oman [NHOSO]”, “South Africa Navy Hydrographic Office [SAN]”, “@ Swisstopo”, “Swiss Lakes Charts with the permission from Cap.Jean DeBosset”, “Abris LLC”, “GeoNames”, “Claymoreclan Design”, “Reliance Globalcom”, “Kingfisher Information Services by Seafish.Org”, “Land Information New Zealand [LINZ]”

This Navionics electronic marine chart incorporates Data which is © “Commonwealth of Australia [“Great Barrier Reef Marine Park Authority”]” 2009. The Data has been used in this Navionics electronic marine chart with the permission of the Commonwealth. The Commonwealth has not evaluated the Data as altered and incorporated within this Navionics electronic marine chart, and therefore gives no warranty regarding its accuracy, completeness, currency or suitability for any particular purpose.

The “Crown in Right of the State of Western Australia” accepts no liability for the accuracy of copying of information contained in this product and does not warrant that this product meets any regulations as an appropriate product for navigation.

This product has been produced by Navionics S.p.A. based on “Canadian Hydrographic Service [CHS]” data, following any minimum standards/guidelines that may have been established by CHS, pursuant to CHS Digital Value-Added Reseller Agreement No. 2012-0605-1260-N. The incorporation of data sourced from CHS in this product shall not be construed as constituting an endorsement by CHS of this product. This product does not meet the requirements of the Charts and Nautical publications Regulations under the Canada Shipping Act, 2001. Certified charts and publications, corrected and up-to-date, must be used to meet the requirements of those regulations.

All above Companies, Institutions and Hydrographic Offices have not verified the product and do not accept liability for its accuracy.

Copyright © 2013 Navionics S.p.A.

NOTE

This product uses Qt software. Qt is licensed under commercial and open source licenses [GNU General Public License version 3 and GNU Lesser General Public License version 2.1]. This portion of the software is free software; you can redistribute it and/or modify it under the terms of the GNU General Public License and GNU Lesser General Public License as published by the Free Software Foundation; either version 3 of the GNU General Public License and version 2.1 of the GNU Lesser General Public License, or [at your option] any later version. This program is distributed in the hope that it will be useful, but WITHOUT ANY WARRANTY; without even the implied warranty of MERCHANTABILITY or FITNESS FOR A PARTICULAR PURPOSE. See the GNU General Public License and GNU Lesser General Public License for more details.

You may receive a copy of the GNU General Public License and GNU Lesser General Public License along with this program; if not, write to the Free Software Foundation, Inc., 51 Franklin Street, Fifth Floor, Boston, MA 02110-1301 USA.

To receive a free copy of the Qt software used in this system, please send a letter of request* with the following information:

Name (First & Last)

Phone Number

E-mail Address

Mailing Address

Humminbird serial number

[Your Humminbird unit must be registered at humminbird.johnsonoutdoors.com/support/productregistration.aspx.]

Shipping and Handling:

We can only accept requests that include a money order in the amount of \$9.99 to cover shipping and handling. Please allow 4-6 weeks for processing.

Send the letter of request* to the following address:

Software Request

Humminbird

678 Humminbird Lane

Eufaula, AL 36027

***NOTE:** A copy of the Qt software is not required to upgrade your fishing system. The Humminbird application software and control head include a separate service warranty. Please see humminbird.johnsonoutdoors.com and the separate warranty card included with your unit for details.

FCC Notice

This device complies with Part 15 of the FCC Rules. Operation is subject to the following two conditions: [1] this device may not cause harmful interference, and [2] this device must accept any interference received, including interference that may cause undesired operation.

⚠ CAUTION

This equipment has been tested and found to comply with the limits for a Class B digital device, pursuant to Part 15 of the FCC Rules. These limits are designed to provide reasonable protection against harmful interference in a residential installation. This equipment generates, uses and can radiate radio frequency energy and, if not installed and used in accordance with the instructions, may cause harmful interference to radio communications. However, there is no guarantee that interference will not occur in a particular installation. If this equipment does cause harmful interference to radio or television reception, which can be determined by turning the equipment off and on, the user is encouraged to try to correct the interference by one or more of the following measures:

- Reorient or relocate the receiving antenna.
- Increase the separation between the equipment and receiver.
- Connect the equipment into an outlet on a circuit different from that to which the receiver is connected.
- Consult the dealer or an experienced radio/TV technician for help.

RF EXPOSURE COMPLIANCE: This device has been evaluated and found compliant in accordance with EU EN 62479:2010 and EN 62311:2008 for human RF exposure.

This product has been so constructed that the product complies with the requirement of Article 10[2] as it can be operated in at least one Member State as examined and the product is compliant with Article 10[10] as it has no restrictions on putting into service in all EU member states.

CE EU DECLARATION OF CONFORMITY: Hereby, Humminbird declares that this device is in compliance with the essential requirements and other relevant provisions of Directive 2014/53/EU. The declaration of conformity may be consulted at <https://www.humminbird.johnsonoutdoors.com/EU-DOC>

UK CA UK DECLARATION OF CONFORMITY: Hereby, Humminbird declares that this device is in compliance with the essential requirements and other relevant provisions of Radio Equipment Regulations 2017.

Class B Device (Broadcasting and communication equipment for home)

This equipment is home use [Class B] electromagnetic wave suitability equipment and to be used at home and it can be used in all areas.

End User License Agreement

This Hydrographic Database is the proprietary and confidential property of Johnson Outdoors Marine Electronics. Unauthorized use, including the copying of this Hydrographic Database, is expressly prohibited. BY USING THE PRODUCT YOU ARE AGREEING TO BE BOUND BY ALL THE TERMS AND CONDITIONS OF THE JOHNSON OUTDOORS ("LICENSOR") LICENSE AGREEMENT ("AGREEMENT") WHICH IS PROVIDED WITH THIS COASTMASTER AND/OR LAKEMASTER DIGITAL MAP PRODUCT ("LICENSED PRODUCT") INCLUDING, WITHOUT LIMITATION, THE USE RESTRICTIONS, WARRANTY DISCLAIMER AND LIMITATIONS OF LIABILITY SET FORTH HEREIN. Under the Agreement, you have a limited, non-exclusive, personal license to use the data contained on the media in this package, on a GPS mapping device for supplemental navigation reference purposes. Licensor and its third-party suppliers retain all rights to the Licensed Product not expressly granted by the Agreement. You are responsible for using official government charts and prudent navigation for safe travel. The Licensed Product and the accompanying documentation are copyrighted works of authorship and contain valuable secret and confidential information proprietary to Licensor and its third-party suppliers who retain the ownership of the information and all copyrights and other proprietary rights therein. You agree to exercise reasonable efforts to protect their proprietary interests. You may NOT modify, adapt, translate, reverse engineer, decompile, disassemble, sub license, rent, lease, or sell any portion of the Data. You may NOT create derivative works based upon the Data. You may NOT place the Data onto a server so that it is accessible via a public network such as the Internet.

LICENSOR AND ITS THIRD-PARTY SUPPLIERS DO NOT WARRANT THE LICENSED PRODUCT WILL MEET YOUR REQUIREMENTS OR THAT ITS OPERATION WILL BE UNINTERRUPTED OR ERROR-FREE. IN NO EVENT WILL COASTMASTER, LAKEMASTER OR ITS SUPPLIERS BE LIABLE TO YOU FOR ANY CONSEQUENTIAL OR INCIDENTAL DAMAGES. Some states or jurisdictions do not allow the exclusion or limitation of consequential or incidental damages, so the above limitations may not apply to you.

Portions of Humminbird Basemap© OpenStreetMap contributors. Portions of Humminbird Basemap sourced from GeoBase®.

Portions of Humminbird Basemap contains information licensed under the Open Government Licence Canada. Portions of Humminbird Basemap copyright 2001 Her Majesty the Queen in Right of Manitoba, as represented by the Minister of Conservation. All rights reserved. Portions of Humminbird Basemap contains information licenced under the GeoNB Open Data Licence. Portions of Humminbird Basemap contains information licenced under the Open Government Licence Ontario.

CONTACT HUMMINBIRD

Any questions relating to the product should be directed to our Help Center at <https://humminbird-help.johnsonoutdoors.com/hc/en-us> or in writing to the address below:

Humminbird Service Department
678 Humminbird Lane
Eufaula AL 36027 USA

Social Media Resources:



Facebook.com/HumminbirdElectronics



X.com (@humminbirdfish)



Instagram.com/humminbirdfishing



YouTube.com/humminbirdtv

