

MEGA LIVE 2 INSTALLATION GUIDE

532996-1_A



 **HUMMINBIRD**®

Accessory Manual

Thank You!

Thank you for choosing Humminbird®, the #1 name in marine electronics. Humminbird has built its reputation by designing and manufacturing top-quality, thoroughly reliable marine equipment. Your Humminbird accessory is designed for trouble-free use in even the harshest marine environment. In the unlikely event that your Humminbird does require repairs, we offer an exclusive Service Policy. For complete details, see the separate warranty card included with your unit. We encourage you to read this manual carefully in order to get the full benefit from all the features and applications of your Humminbird product.

Contact Humminbird Technical Support through our Help Center at <https://humminbird-help.johnsonoutdoors.com/hc/en-us>.

WARNING

This device should not be used as a navigational aid to prevent collision, grounding, boat damage, or personal injury. When the boat is moving, water depth may change too quickly to allow time for you to react. Always operate the boat at very slow speeds if you suspect shallow water or submerged objects.

The electronic chart in your Humminbird unit is an aid to navigation designed to facilitate the use of authorized government charts, not to replace them. Only official government charts and notices to mariners contain all of the current information needed for the safety of navigation, and the captain is responsible for their prudent use.

Humminbird is not responsible for the loss of data files (waypoints, routes, tracks, groups, recordings, etc.) that may occur due to direct or indirect damage to the unit's hardware or software. It is important to back up your control head's data files periodically. See your control head operations manual for details.

Disassembly and repair of this electronic unit should only be performed by authorized service personnel. Any modification of the serial number or attempt to repair the original equipment or accessories by unauthorized individuals will void the warranty.

NOTES

Some features discussed in this manual require a separate purchase. Every effort has been made to clearly identify those features. Please read the manual carefully in order to understand the full capabilities of your model.

The illustrations in this manual may not look the same as your product, but your unit will function in the same way.

To purchase accessories, visit our Web site at [humminbird.johnsonoutdoors.com](https://humminbird-johnsonoutdoors.com) or Contact Humminbird Technical Support through our Help Center at <https://humminbird-help.johnsonoutdoors.com/hc/en-us>.

The procedures and features described in this manual are subject to change without notice. This manual was written in English and may have been translated to another language. Humminbird is not responsible for incorrect translations or discrepancies between documents.

Product specifications and features are subject to change without notice.

Humminbird verifies maximum stated depth in saltwater conditions, however actual depth performance may vary due to transducer installation, water type, thermal layers, bottom composition, and slope.

APEX™, Fortrex™, Humminbird®, MEGA Imaging™, Minn Kota®, One-Boat Network®, QUEST™, SOLIX®, Ultrex™, XPLORE™ are trademarked by or registered trademarks of Johnson Outdoors Marine Electronics, Inc.

Table of Contents

Introduction	1
Compatibility.....	1
Supplies.....	2
Update Software	3
Check the Current Software Version	3
Update Fish Finder Software with an SD Card	3
Update Accessory Software with an SD Card	4
Install the Trolling Motor Mount	5
1. Prepare for Installation	5
2. Attach the Landscape Mode Mount to the Shaft Mount	6
3. Install the Shaft Mount	9
4. Install the MEGA Live 2 Transducer	10
5. Install the Mask.....	14
6. Route the Cables and Connect Power.....	15
Install the Choke Cable	20
1. Determine Whether to Install the Choke Cable.....	20
2. Install the Choke Cable.....	20
Set Up the Fish Finder	22
1. Confirm Connections	22
2. Set Up MEGA Live 2 on the Fish Finder	24
3. Test MEGA Live 2 on the Fish Finder	24
4. Confirm the Heading Sensor Operation	28
5. Set Up the Network	29
Power Off	30

Table of Contents

Maintenance	31
Fish Finder Maintenance.....	31
Transducer Maintenance	32
MEGA Live 2 Maintenance	32
Troubleshooting	33
Fishing System Doesn't Power Up	33
Finding the Cause of Noise	34
Specifications	35
Contact Humminbird	38

Introduction

This manual will guide you through the following installation requirements for the MEGA Live 2 transducer:

- Installing the Transducer
- Connecting to the Fish Finder and Power
- Testing the Installation
- Powering Off

Before proceeding with this installation, the Humminbird fish finder and Minn Kota trolling motor should be installed. The MEGA Live 2 transducer can be connected directly to the fish finder or to a Humminbird Ethernet Switch (optional, separate purchase required) for networking. See the Ethernet Switch installation instructions to install the Ethernet Switch.

Compatibility

Fish Finders: MEGA Live 2 is compatible with all XPLORE™ Series and APEX™ Series fish finders as well as SOLIX® Series G3 fish finders. It can be mounted on all Minn Kota Ultrex trolling motors and on Minn Kota Fortrex trolling motors.

Minn Kota Trolling Motor	Humminbird Fish Finder
Minn Kota Fortrex	XPLORE Series: All models
Minn Kota Ultrex (all models)	APEX Series: All models
Minn Kota Ultrex QUEST	SOLIX Series: G3 models

NOTE

You must have a GPS heading sensor (compass) installed in order to use the MEGA Live 2 navigation features.

Cables: Your MEGA Live 2 transducer comes with the cables required to connect directly to your Humminbird fish finder. In addition to the cables permanently attached to the transducer, this includes two extension cables (a 10' MEGA Live power cable and a 20' Ethernet cable) to allow for quick-disconnect.

NOTE

An ethernet switch (separate purchase required) can be used to connect your MEGA Live 2 transducer to multiple fish finders. To purchase accessories for your fish finders, visit our Web site at humminbird.johnsonoutdoors.com or Contact Humminbird Technical Support through our Help Center at <https://humminbird-help.johnsonoutdoors.com/hc/en-us>.

Accessories: Additional recommended accessories include a Humminbird Heading Sensor GPS Puck or NMEA 2000 GPS Heading Sensor, or a Minn Kota Heading Sensor connected to an Advanced GPS trolling motor. For the most current list of compatible accessories, visit our Web site at humminbird.johnsonoutdoors.com.

Supplies

In addition to the hardware included with your accessory, you will need the following supplies:

- Cable ties for cable routing
- 2 Amp fuse
- Multi-bit screwdriver

Switch (optional): If you do not have a main switch or fuse panel available on your boat to connect power, you will need to purchase a battery switch. See *Install the Trolling Motor Mount, Section 6: Route the Cables and Connect Power* for more information.

Update Software

Your fish finder model may need a software update to work with the MEGA Live 2 transducer. We recommend that you read the following section completely before starting any software updates.

NOTE

It is important to install the latest software update on your fish finder to enable all MEGA Live 2 features. For the latest software update, visit our Web site at **humminbird.johnsonoutdoors.com**.

Check the Current Software Version

It is helpful to review the software version number that is currently installed on the fish finder and each accessory.

1. Press the HOME key.
2. Select Settings.
3. Select System > Network Info.
4. The Network Info dialog box shows a section for each device connected to the network. Scroll to each section to note the software version number listed.

Update Fish Finder Software with an SD Card

You will need an SD or microSD card (depending on your fish finder model).

CAUTION

Humminbird is not responsible for the loss of data files (waypoints, routes, tracks, groups, snapshots, recordings, etc.) that may occur due to direct or indirect damage to the unit's hardware or software.

1. Install a formatted SD or microSD card into the computer card slot.
2. Go to **humminbird.johnsonoutdoors.com**, and click Support > Software Updates.
3. Click on your fish finder model. The available software updates are listed as downloads under each product. Confirm the file name is for your fish finder model.
 - Read the notices and instructions, and select Download.
 - Follow the on-screen prompts to save the software file to the SD or microSD card.

4. Power on your Humminbird fish finder. Start **Normal** mode.
5. Insert the SD or microSD card (with the software file) into the fish finder card slot.
6. Follow the on-screen prompts to update the fish finder software.

The software can be installed at a later time by using the Software Updates tool.

7. When the software update is complete, remove the SD or microSD card from the fish finder card slot.

Update Accessory Software with an SD Card

You will need an SD or microSD card (depending on your fish finder model).

1. Install a formatted SD or microSD card into the computer card slot.
2. Go to **humminbird.johnsonoutdoors.com**, and click Support > Software Updates.
3. Scroll down to Accessories and Mapping. The available software updates are listed as downloads under each accessory product. Confirm your fish finder model is listed in the software description.
 - Read the notices and instructions, and select Download.
 - Follow the on-screen prompts to save the software file to the SD or microSD card.
4. Power on your Humminbird fish finder. Start **Normal** mode.
5. Insert the SD or microSD card (with the software file) into the fish finder card slot.
6. Select Tools > Software Updates. Scroll to MEGA Live 2 on the Accessories list. Confirm that the most current software version is selected from the list, and select Install Now.
7. When the software update is complete, remove the SD or microSD card from the fish finder card slot.

Install the Trolling Motor Mount

Use the following instructions to install the MEGA Live 2 transducer on your Minn Kota trolling motor. It is important to read the instructions completely and understand the mounting guidelines before you start the installation.

1. Prepare for Installation

1. The trolling motor should be in the fully retracted (flat) position on the boat deck for this installation.
2. Disconnect the motor from all sources of electrical power.
3. Test run the Ethernet cable from the chosen mounting location on the trolling motor to the fish finder or ethernet switch. Test run the power cable from the chosen mounting location on the trolling motor to the main switch or fuse panel.

It is important to consider the following:

- The MEGA Live 2 transducer is powered separately from the fish finder. It must be connected to a switch where it can be powered on when the boat is underway and powered off when it is docked.
 - The cables should be routed through an established routing system on the boat, in an area with minimal interference, without sharp edges, obstacles, or obstructions that may damage the cables.
 - The cables will move with the trolling motor when it is deployed and retracted, so it is important to allow enough length for movement.
4. With the trolling motor deployed, the transducer has the following installation requirements:
 - The transducer should not have anything obstructing the 'view' of the beams. If possible, move anything to the sides and below the transducer that might obstruct the sight line of the beams.

2. Attach the Landscape Mode Mount to the Shaft Mount

Use the following instructions to attach the Landscape Mode mount onto the shaft mount.

1. Fold the Landscape Mode mount down using the dual release buttons.
2. **For installation on an Ultrex or Fortrex trolling motor**, secure the included small rubber pads to the inside of the shaft mount as shown in the illustration *Shaft Mount Rubber Pad Placement*. Remove the backing from the pads and press the adhesive sides firmly into place against the shaft mount.

Landscape Mode Mount

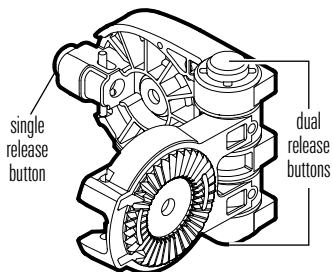

Shaft Mount Rubber Pad Placement

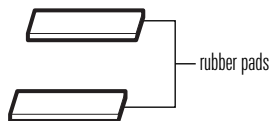
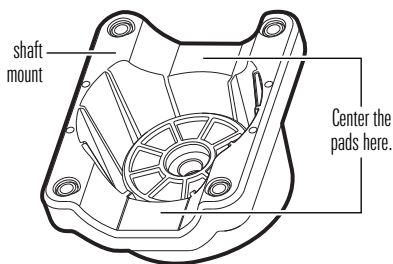

For installation on an Ultrex QUEST trolling motor, rubber pads are not needed. Proceed to Step 3.

3. Align the key on the shaft mount and the Landscape Mode mount to connect them.

Connecting the Shaft Mount to the Landscape Mode Mount

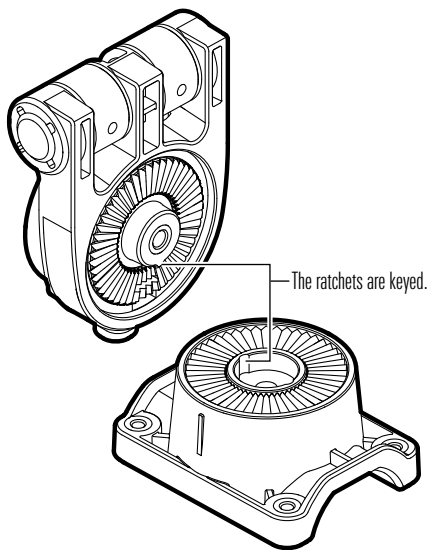

4. Secure the shaft mount to the Landscape Mode mount with one of the included lock washers and 1/4-28 screws, using the provided hex bit. Hand tighten the screw until the lock washer is fully compressed (see the illustration ***Compressing the Lock Washer***), and then tighten an additional 1/4 turn. **Hand tighten only!**

⚠ CAUTION

The screw and lock washer **MUST** be fully tightened. Failure to do so may result in the transducer detaching from the Landscape Mode mount in the water.

Compressing the Lock Washer

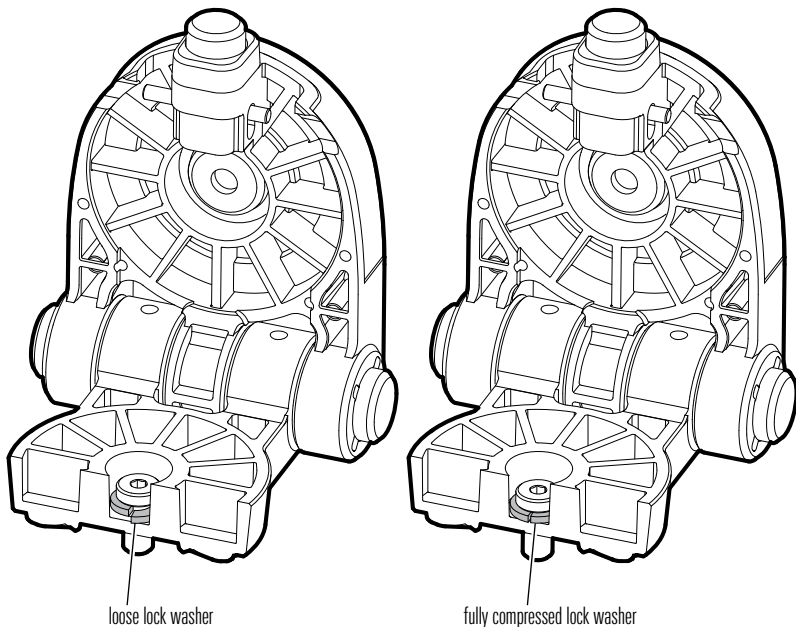

3. Install the Shaft Mount

CAUTION

Disconnect the motor from all sources of electrical power before you start installation.

1. The trolling motor should be in the fully retracted (flat) position on the boat deck for this installation.
2. Disconnect the motor from all sources of electrical power.
3. Determine if the transducer will be installed on the left or right side of the trolling motor.

If the trolling motor prop stows on the right (starboard) side of the boat, you will mount the transducer on the right side of the trolling motor.

If the trolling motor prop stows on the left (port) side of the boat, you will mount the transducer on the left side of the trolling motor.

Starboard Installation

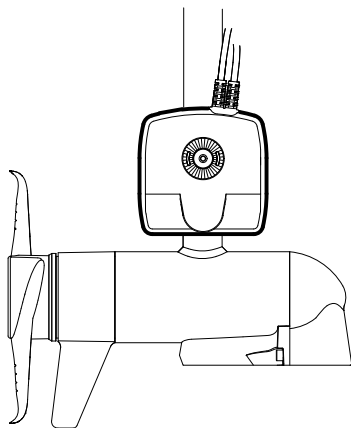

Port Installation

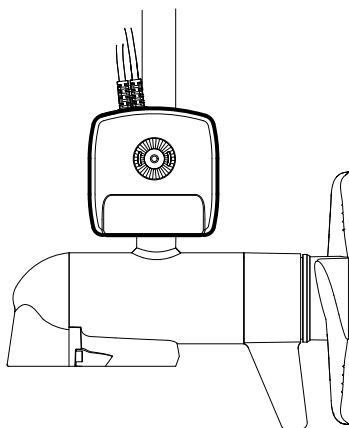

4. For installation on an **Ultrix** or **Fortrex** trolling motor, secure the included large rubber pad to the inside of the shaft clamp as shown in the illustration **Shaft Clamp Rubber Pad Placement**. Remove the backing from the pad and press the adhesive side firmly into place against the shaft clamp.

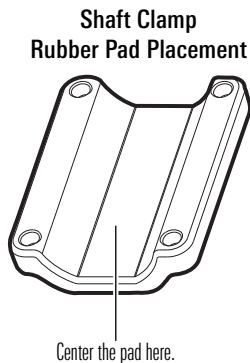

For installation on an Ultrix QUEST trolling motor, the rubber pad is not needed. Proceed to Step 5.

5. With the trolling motor stowed, align the shaft mount and shaft clamp around the base of the trolling motor shaft.

Optional: The transducer can be installed farther up the trolling motor shaft if desired.

6. Secure the shaft clamp to the shaft mount by installing the (4) #10-32 screws into the threaded holes on the clamp using the provided 5/32" Allen wrench. Do not fully tighten.

4. Install the MEGA Live 2 Transducer

1. Rotate the Landscape Mode mount until the single release button faces the bottom of the trolling motor.

NOTE

Your transducer will flip up for landscape mode when installed in the Recommended Configuration. If you prefer to flip your transducer down for landscape mode (see the illustration **MEGA Live Views** in **Section 6. Route the Cable and Connect Power**), use the Optional Configuration.

2. The Landscape Mode mount should be open for this step of the installation. Unlock the mount by pressing down on the single release button, and pull the mount open. It will relock automatically once fully opened.
3. **Recommended Configuration:** With the Landscape Mode mount open, mount the transducer with the cables closest to the trolling motor shaft (see the illustration **Positioning the Landscape Mode Mount: Recommended Configuration**).

Positioning the Landscape Mode Mount: Recommended Configuration

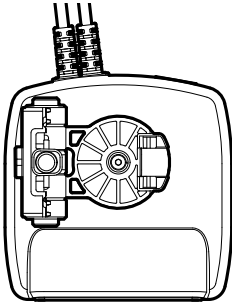

Hinge on Left (Back)

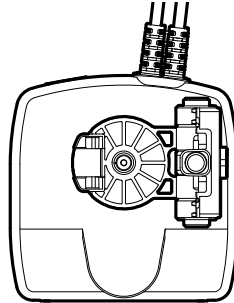

Hinge on Right (Front)

MEGA 360 users should install MEGA Live 2 using the Optional Configuration.

Optional Configuration: Mount the transducer with the cables farthest from the trolling motor shaft (see the illustration *Positioning the Landscape Mode Mount: Optional Configuration*).

Positioning the Landscape Mode Mount: Optional Configuration

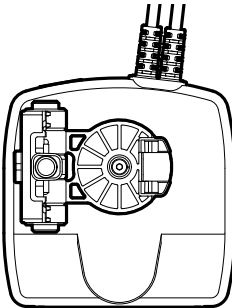

Hinge on Left (Front)

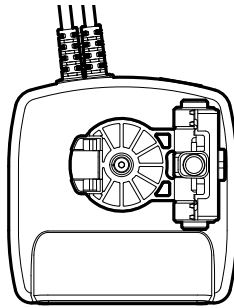

Hinge on Right (Back)

4. Connect the Landscape Mode mount to the transducer according to your Recommended or Optional configuration.

The ratchets are keyed to allow for Port or Starboard installation. The ribs on the Landscape Mode mount ratchet should align with the marks on your transducer.

Connecting the Landscape Mode Mount to the Transducer

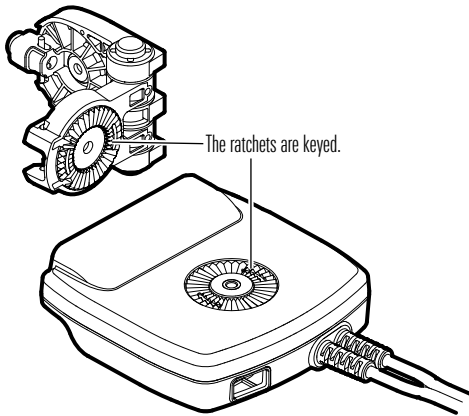

5. Secure the transducer to the Landscape Mode mount with one of the included lock washers and 1/4-28 screws, using the provided hex bit. Hand tighten the screw until the lock washer is fully compressed (see the illustration *Compressing the Lock Washer*), and then tighten an additional 1/4 turn. **Hand tighten only!**

CAUTION

The screw and lock washer **MUST** be fully tightened. Failure to do so may result in the transducer detaching from the Landscape Mode mount in the water.

6. Rotate the MEGA Live 2 transducer around the shaft until it is parallel with the lower unit of the trolling motor (see *Aligning the Transducer*). This ensures the transducer is pointing in the same direction as the trolling motor.

Aligning the Transducer

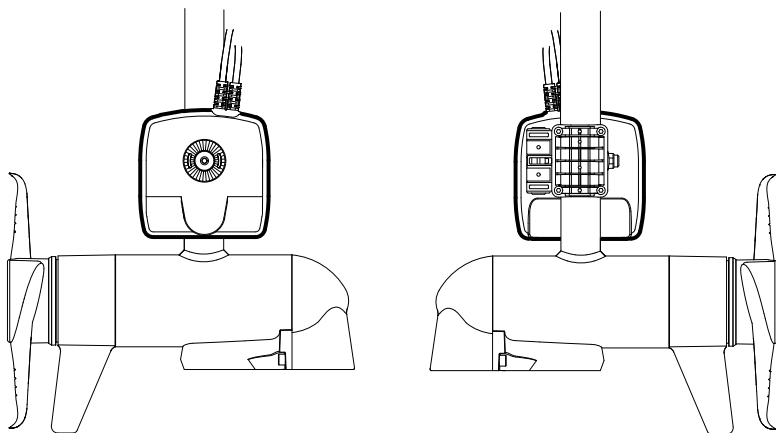

7. Fully tighten the screws until the transducer cannot be moved on the shaft.
Hand-tighten only!

5. Install the Mask

When operating your MEGA Live 2 transducer in Forward Mode, your sonar return may include faint double images caused by the beams bouncing off the surface of the water. To prevent this, it is recommended to apply the included mask to your transducer using the following instructions.

NOTE

For additional information, a video tutorial is available at <https://humminbird.johnsonoutdoors.com/us/mega-live-2-starter-guide>.

1. Clean your transducer with rubbing alcohol.
2. Remove the backing from the mask and press the adhesive side firmly into place against the side of the transducer that will face up (as shown in the illustration *MEGA Live 2 Mask Placement*).

NOTE

The side of the transducer that will face up is dependent on your installation configuration. Two unique masks are included with your accessory. Each mask is contoured to fit one side of the transducer. For use at 60°, use a long mask (7/8"). For use at 45°, use a short mask (1/2"). If you plan to switch between angles frequently, Humminbird recommends using the short mask (1/2").

MEGA Live 2 Mask Placement

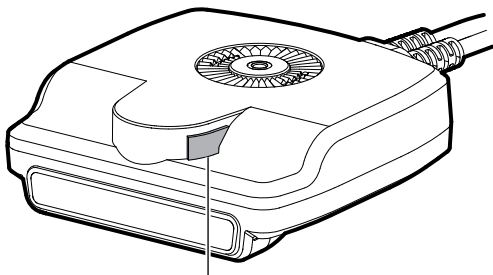

Place mask here on the side of the transducer that will face up.

6. Route the Cables and Connect Power

WARNING

Disconnect the motor from all sources of electrical power before you start installation.

1. Position the first molded anchor point 4-5 inches from the top of the mount. Secure it with a cable tie. Do not fully tighten.

Molded Anchor Point

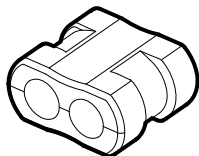

CAUTION

To avoid damaging the cables, apply cable ties **ONLY** at the designated anchor points.

2. Rotate the transducer by hand to test the Down, Forward and Landscape Mode views as illustrated in *MEGA Live Views* to ensure proper slack in the cables. Your trolling motor mount includes guides to help you position the transducer correctly (see the illustration *MEGA Live Mode Guides*).

To alternate between Down and Forward views, rotate the transducer on its mount using both hands.

To change from Down or Forward view to Landscape Mode, press the single release button on the hinge until the mount unlocks. Flip the transducer out until the hinge locks.

To adjust the Landscape Mode angle, rotate the transducer on its mount using both hands.

MEGA Live Mode Guides

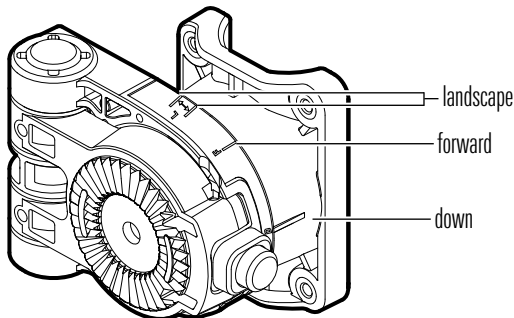

MEGA Live Views

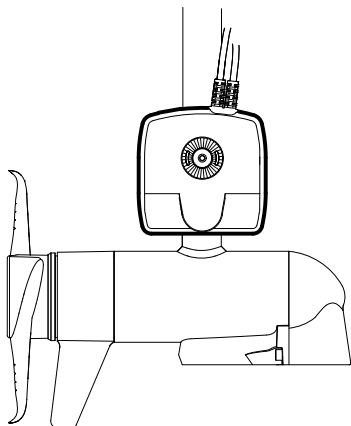

Down View

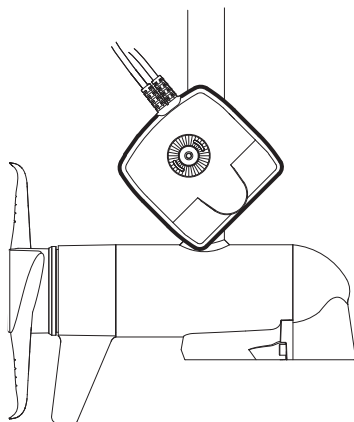

Forward View

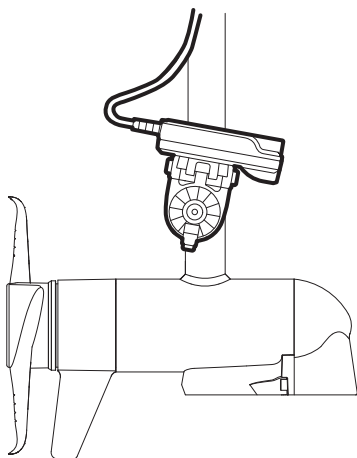

Recommended Landscape Mode

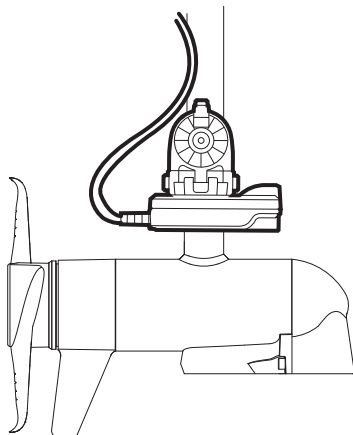

Optional Landscape Mode

3. Adjust the first anchor point as needed and then fully tighten the cable tie.

- Secure the remaining anchor points with cable ties as you route the cables up the trolling motor shaft.

Depending on your installation configuration and motor's shaft length, you may not need all five anchor points.

- Route the rest of the cables to the side of the trolling motor, over the bow, to the chosen connection locations in **Section 1: Prepare for Installation**. Leave sufficient slack in the cables to allow for full movement of the trolling motor during normal operation (see **Routing the Cables**).

Routing the Cables

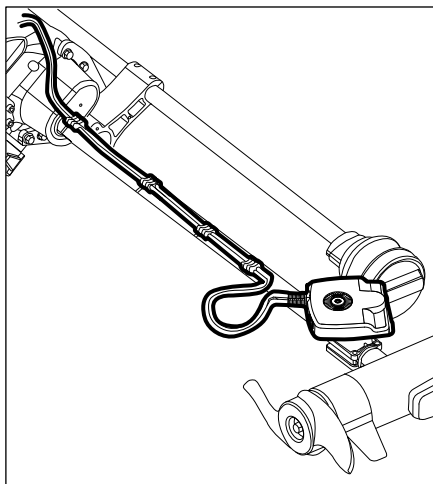

CAUTION

Do NOT mount the cables where the connectors could be submerged in water or flooded. If cables are installed in a splash-prone area, it may be helpful to apply dielectric grease to the inside of the connectors to prevent corrosion. Dielectric grease can be purchased separately from a general hardware or automotive store.

NOTES

The cables should be routed through an established routing system on the boat, in an area with minimal interference. Inspect the selected route carefully to ensure that there are no sharp edges, obstacles, or obstructions that may damage the cables. Avoid pinch points created by stowing or deploying the trolling motor.

You must ensure your MEGA Live 2 ethernet and power wires are installed in a location where they will not be cut or ripped by the trolling motor articulating or rotating. Wires damaged by improper installation are NOT covered by the product warranty.

- Ethernet:** Insert the Ethernet Cable into the Ethernet port on the fish finder. Hand-tighten the screw nut.
- Power:** Route the power cable to the main switch or fuse panel (usually located near the console). If you must connect to a battery, connect to a battery switch (not included).

Hand-tightening the Screw Nut

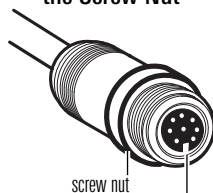

The connectors are keyed to prevent reversed installation.

⚠ CAUTION

The MEGA Live 2 transducer should be connected to a main switch, fuse panel, or battery switch. Humminbird does not recommend connecting to a battery without a fuse and a switch.

Some boats have 24 or 36 Volt electric systems, but the MEGA Live 2 transducer **MUST** be connected to a 12 VDC power supply.

NOTES

Humminbird is not responsible for over-voltage or over-current failures. The MEGA Live 2 transducer must have adequate protection through the proper selection and installation of a 2 Amp fuse.

A 10' (3 m) power cable is included to supply power to the MEGA LIVE 2 transducer. You may shorten or lengthen the cable using 12 gauge multi-stranded copper wire.

- 8a. **Main Switch/Fuse Panel:** If a fuse terminal is available, use crimp-on type electrical connectors (not included) that match the terminal on the fuse panel. Attach the black wire to ground (-), and the red wire to positive (+) 12 VDC power, and the drain/shield wire to the boat's chassis ground terminal. Install a 2 Amp fuse (not included) for protection of the unit.

Connecting to the Fuse Panel

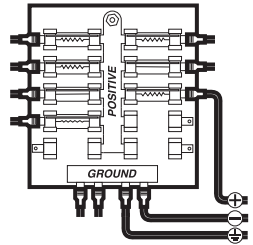

OR

- 8b. **Battery Switch:** Install the battery switch (not included) using the instructions provided with it. You will also need to obtain and install an inline fuse holder and a 2 Amp fuse (not included) for the protection of the unit. Attach the black wire to ground (-), the red wire to positive (+) 12 VDC power, and the drain/shield wire to the boat's chassis ground terminal.

CAUTION

If you are unable to obtain a battery switch and are forced to connect the power cable directly to the battery, be aware that this will drain the battery. Humminbird does not recommend connecting to a battery without the appropriate fuse and a switch.

NOTE

The drain/shield wire is the non-tinned black wire.

9. Secure the cables along the route as needed for a clean assembly.

Install the Choke Cable

Reduce noise interference (if needed) using the included choke cable.

1. Determine Whether to Install the Choke Cable

If an on-board charger is present and attached to the cranking battery, install the choke cable (included) to reduce noise interference in the transducer.

If there is not an on-board charger connected to the cranking battery, the choke cable is not required.

2. Install the Choke Cable

Use the following instructions to install the choke cable.

Supplies: Wire cutter, wire stripper, wire crimper, safety glasses, protective gloves, and a heating agent.

WARNING

Disconnect the power source for all related equipment before you start installation.

1. Disconnect the on-board charger from the main power source.
2. Disconnect the charger cable from the cranking battery.
3. Use a wire cutter to cut the charger cable between the fork in the output cable and the fuse holder. The fuse holder should always remain within 7" of the battery terminals.

Cutting the Charger Cable

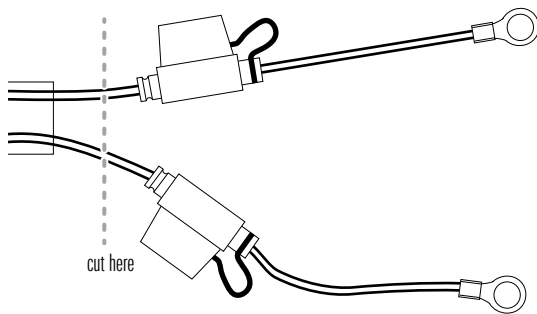

- Strip back the shield on each end of the cut wires approximately 1/4 inch (6.4 mm).
- Connect the stripped wires of the charger cable to the choke using the butt connectors on both sides of the cut wire (red to white and black to black).
- Securely crimp the wires in the butt connectors.
- Apply heat over the splice connection shrink insulation to secure the connection.

 **CAUTION**

Use extreme caution when applying heat to the shrink insulation.

- Connect the terminals on the charger cable to the cranking battery.

Set Up the Fish Finder





Use the following instructions to power on the fish finder and confirm the MEGA Live 2 transducer and the GPS Heading Sensor are detected by the unit.





CAUTION

It is important to finish all installation connections before powering on the fish finder. It may take up to a minute for the MEGA Live 2 transducer and other attached equipment to be detected by the fish finder.

1. Confirm Connections

1. Turn on the power source from the main switch.
2. On the fish finder, press the POWER key. **If you are powering on a fish finder in a multiple-fish finder Ethernet network**, power on the fish finder that is connected to the MEGA Live 2 transducer first.
3. Select Normal mode.
4. From the home screen, review the status bar in the top right corner of the screen to confirm the sensor status for the MEGA Live 2 transducer and that the GPS Receiver/Heading Sensor is connected.

MEGA Live 2 Status Icon	Icon Description
	Connected/In Water/Pinging: The MEGA Live 2 is connected, in the water, and pinging.
	Connected/In Water/Not Pinging: The MEGA Live 2 is connected and in the water, but it is not pinging.
	Connected/Out of Water: The MEGA Live 2 is connected, but the wet indicator is out of the water.
	Connection Lost: The connection to the MEGA Live 2 was lost.

GPS Heading Sensor Icon	Icon Description
	Compass: The selected heading sensor is on and heading data is being received.
	Detected and Active: The GPS receiver is detected and a GPS fix has been obtained.
	Connected but not Detected or Active: The GPS receiver is connected, but not detected on the network or no GPS fix has been obtained.
	Connected but not Transmitting/Receiving: The GPS receiver is detected, but it doesn't have a GPS fix.

NOTE

For additional system status, select Home > Settings > System > Network Info.

MEGA Live 2 Transducer Connected



MEGA Live 2
listed

2. Set Up MEGA Live 2 on the Fish Finder

Your XPLORE, APEX, or SOLIX fish finder will automatically detect and subscribe to MEGA Live 2. To review the selected sonar sources, open the XPress menu and select Settings > MEGA Live 2 Source.

Reviewing Sonar Sources

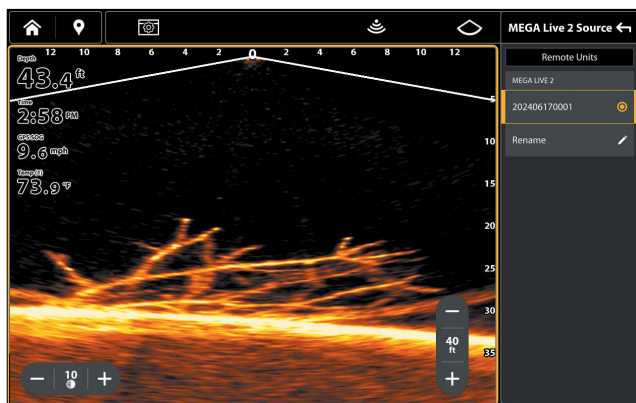

3. Test MEGA Live 2 on the Fish Finder

It is important to confirm that the MEGA Live 2 transducer is providing sonar returns to the display. The instructions in this section should be performed at trolling speeds in calm, open water, in a large area that is far from shallow water, boats, or other obstacles.

1. From the Home screen, tap the View icon in the menu tray.

NOTE

Once the MEGA Live 2 has been detected the first time, the MEGA Live 2 view will display on the Favorite Views widget.

2. Tap MEGA Live 2 and select your preferred MEGA Live 2 view.
3. The sonar returns from the MEGA Live 2 will begin to display on the MEGA Live 2 View. Review the display for the following information and see the illustrations *Reviewing the MEGA Live 2 View*.
 - **Bottom:** Confirm that the bottom is visible on-screen.

- **Blocked Beams:** If the beams hit a hard surface, it will appear as bright white on the display. If the beams are blocked by any objects, move the objects if possible. You can also adjust the MEGA Live 2 Range on the X-Press Menu to see more or less detail on the display.
4. **Stop Pinging:** When you are finished reviewing the operation, tap the Ping icon  from the MEGA Live 2 top bar.

Ping on: 

Ping off: 

Reviewing the MEGA Live 2 View

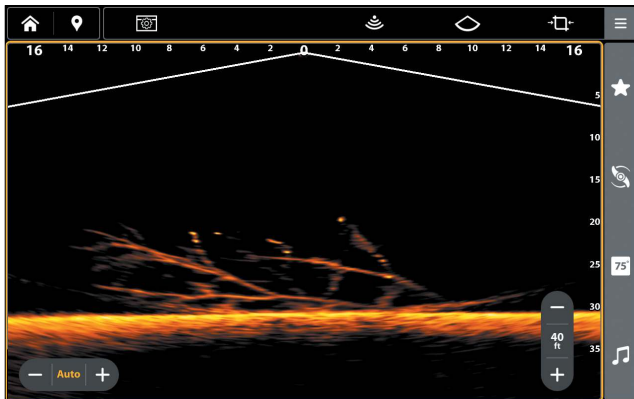

(Down)

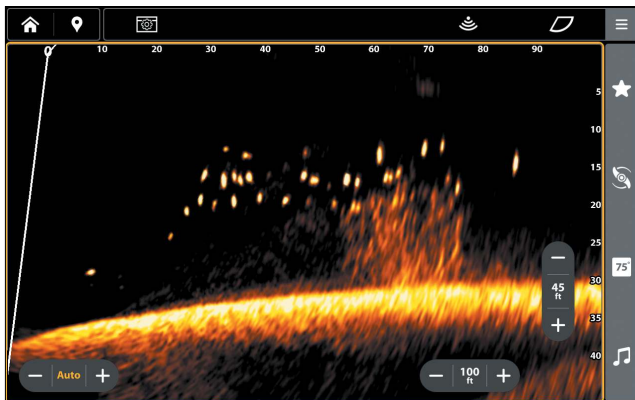

(Forward)

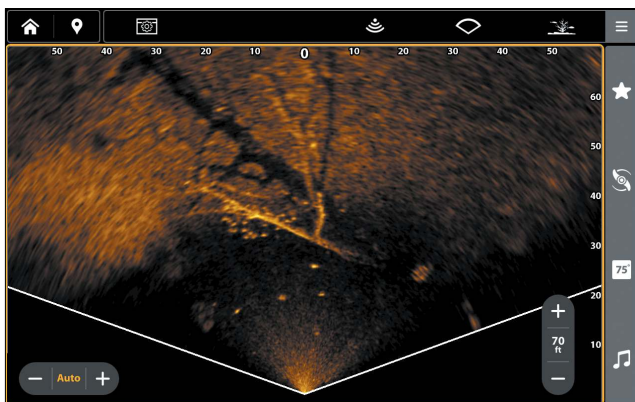

(Landscape)

Changing the MEGA Live Mode

Your fish finder will automatically select the best mode for your installation. Use the following instructions to manually change the MEGA Live Mode to Down, Forward, or Landscape.

1. With a MEGA Live 2 View displayed on-screen, tap the MEGA Live Mode icon in the top bar.
2. Tap Auto, or use the Cursor pad and Enter key, to turn Auto off.
3. Tap, or use the Cursor pad and Enter key, to select a MEGA Live Mode.

Down Mode: 

Forward Mode: 

Landscape Mode: 

When you manually change the MEGA Live Mode, a message box will display reminding you to also change the transducer's installation orientation. For instructions on changing the installation orientation, see Step 2 of ***Install the Trolling Motor Mount, Section 6: Route the Cables and Connect Power.***

Changing the MEGA Live Mode

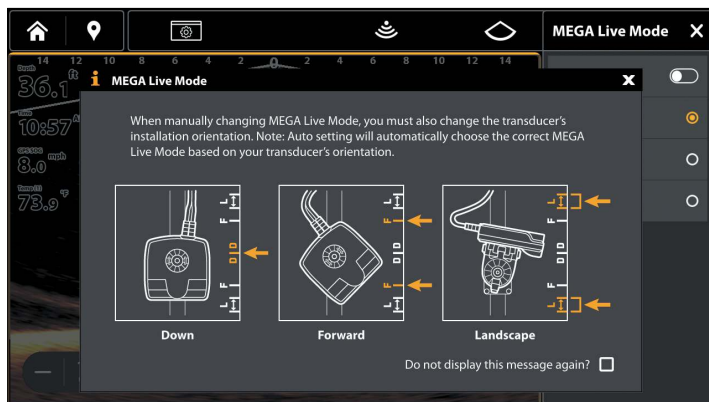

4. Confirm the Heading Sensor Operation

It is important to confirm that the Heading Sensor is installed correctly by reviewing the heading digital readout.

NOTE

This procedure should be performed at slow speeds, in calm, open water, in a large area that is far from shallow water, boats, or other obstacles.

1. Press the HOME key.
2. Select Settings > User Preferences > Units > Compass > Magnetic North.
3. With a Chart View displayed on-screen, navigate the boat in a straight line, in calm, open water at 4.5 mph. Compare the Heading digital readout on the screen with the Course (COG) digital readout. The readouts should be within approximately 5° of each other.

Adjust: To adjust the zero point of the Heading Sensor, select Settings > NMEA 2000 > Data Offsets. Select Heading Adjustment. Tap the on/off button, or press the ENTER key, to turn it on. Press and hold the slider, or press and hold the ENTER key, to adjust the setting.

If the procedure failed: If the Heading digital readout is significantly different than the COG, the Heading Sensor might be installed in a location with too much magnetic interference. Check the installation location and possible magnetic disturbances in the area.

Confirming the Heading Digital Readout (Chart View)

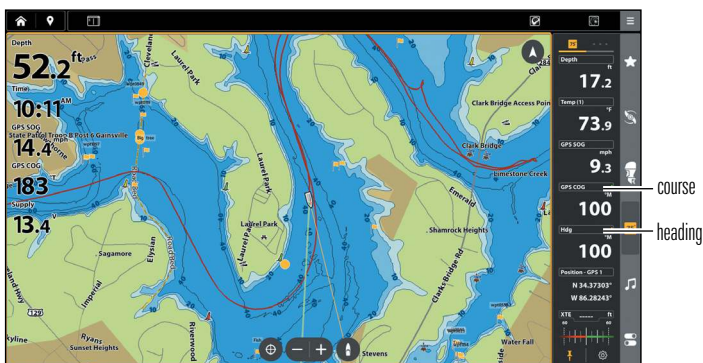

Confirming the Heading Digital Readout (Sonar View)

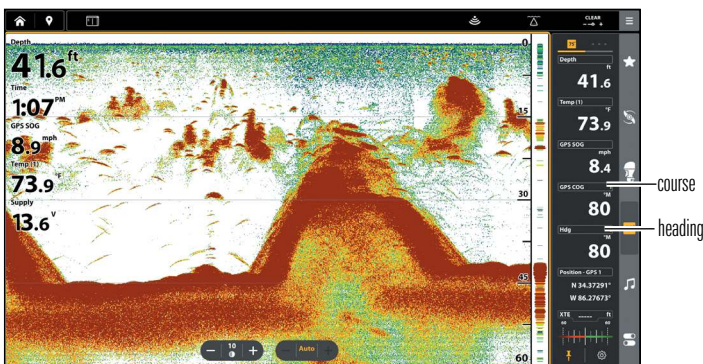

5. Set up the Network

After you have confirmed all connections, the MEGA Live 2 transducer is ready to use on the water. Proceed to your *MEGA Live 2 Operations Manual* to set up the temperature and additional sonar sources.

Power Off

CAUTION

When the boat is stored or at dock, the MEGA Live 2 transducer must be turned off to prevent draining the battery.

Power Off the Fish Finder

1. During operation, press the POWER key and select Power Off.

CAUTION

Turning off the fish finder will NOT power off the MEGA Live 2 transducer.

2. Turn off power on the main switch, breaker, or battery switch.

Powering off the MEGA Live 2 transducer will be determined by the installation and power connection on your boat.

Travel with the MEGA Live 2 Transducer Installed

The MEGA Live 2 transducer must not hit the deck, base, or any objects. This is critical during transport. Check the tension of the trolling motor bracket after initial use and periodically thereafter to ensure the installation remains stable.

Maintenance

Your Humminbird fish finder is designed to provide years of trouble free operation with very little maintenance. Use the following procedures to ensure your Humminbird continues to deliver top performance.

Fish Finder Maintenance

It is important to consider the following precautions when using your Humminbird fish finder:

- **Chemicals**, such as those found in bug spray and sunscreen, may cause permanent damage to the fish finder screen. Such damage is not covered by the warranty.
- **NEVER leave the fish finder in a closed car or trunk.** The high temperatures generated in hot weather can damage the electronics.

Use the following information to keep the fish finder and screen clean.

- **Screen:** To clean the fish finder screen, use a mild soap (such as a nonabrasive liquid hand soap) and warm water. Wipe the screen dry with a soft cloth. Be careful to avoid scratching the screen. If water spots remain, use a solution of water and vinegar.

CAUTION

Do not use a chemical glass cleaner on the screen. Chemicals in the solution may cause cracking in the lens of the unit.

NOTE

Do not wipe the screen while dirt or grease is on the screen.

- **Fish Finder:** If the fish finder comes into contact with salt spray, wipe the affected surfaces with a cloth dampened with fresh water.

Transducer Maintenance

Use the following information to maintain the transducer operation.

- If your boat remains in the water for long periods of time, algae and other marine growth can reduce the effectiveness of the transducer. Periodically clean the face of the transducer with a cloth dampened with fresh water.
- If your boat remains out of the water for a long period of time, it may take some time to wet the transducer when it is returned to the water. Small air bubbles can climb to the surface of the transducer and interfere with proper operation. These bubbles dissipate with time, or you can wipe the face of the transducer with your fingers after the transducer is in the water.

MEGA Live 2 Maintenance

Use the following information to maintain the installation of the MEGA Live 2 Transducer.

- Check the stability of the trolling motor mount after initial use and periodically thereafter to ensure that the installation remains stable.
- If your boat will be in long-term storage, remove the MEGA Live 2 transducer and store it in -40°F to 158°F (-40°C to 70°C), dry conditions.

Troubleshooting

Before contacting the Humminbird Technical Support, please read the following section. Taking the time to review these troubleshooting guidelines may allow you to solve a performance problem yourself, and therefore avoid sending your unit back for repair.

Fishing System Doesn't Power Up

If your Fishing System doesn't power up, use the installation guide that is included with your Fishing System to confirm specific details, making sure that:

- the power cable is properly connected to the Fishing System control head,
- the power cable is wired correctly, with red to positive battery terminal and black to negative terminal or ground, and the drain/shield wire to the boat's chassis ground terminal,
- the fuse is operational, and
- the battery voltage of the power connector is at least 12 Volts.

Correct any known problems, including removing corrosion from the battery terminals or wiring, or actually replacing the battery if necessary.

Finding the Cause of Noise

Electrical noise usually affects the display with streaks or repetitive patterns on the view. One or more of the following sources can cause noise or interference:

Possible Source of Noise	Isolation
Other electronic devices	Turn off any nearby electronic devices to see if the problem goes away, then turn them on one at a time to see if the noise re-appears.
Other sonar devices	Turn off any nearby sonar devices to see if the problem goes away, then turn them on one at a time to see if the noise re-appears.
The boat's engine	To determine whether the boat's engine is the source of the noise, increase the RPMs while the boat is in neutral and stationary to see if the noise increases proportionately; if noise appears when you rev the engine, the problem could be the spark plugs, alternator, or tachometer wiring. Replace the spark plugs with resistor plugs, install an alternator filter, or route the control head power and transducer cables away from the engine wiring.

Specifications

Operating Frequency.....	1.05 CHIRP MHz
Power Requirement.....	10 to 20 VDC
Current Draw	1.15 A maximum
Operating Temperature.....	32°F to 158°F (0°C to 70°C)
Storage Temperature	-31°F to 185°F (-35°C to 85°C)

NOTES

Humminbird verifies maximum stated depth in saltwater conditions, but actual depth performance may vary due to transducer installation, water type, thermal layers, bottom composition and slope.

Product specifications and features are subject to change without notice.

ROHS STATEMENT: Product designed and intended as a fixed installation or part of a system in a vessel may be considered beyond the scope of Directive 2002/95/EC of the European Parliament and of the Council of 27 January 2003 on the restriction of the use of certain hazardous substances in electrical and electronic equipment.

ENVIRONMENTAL COMPLIANCE STATEMENT: It is the intention of Johnson Outdoors Marine Electronics, Inc. to be a responsible corporate citizen, operating in compliance with known and applicable environmental regulations, and a good neighbor in the communities where we make or sell our products.

WEEE DIRECTIVE: EU Directive 2002/96/EC “Waste of Electrical and Electronic Equipment Directive (WEEE)” impacts most distributors, sellers, and manufacturers of consumer electronics in the European Union. The WEEE Directive requires the producer of consumer electronics to take responsibility for the management of waste from their products to achieve environmentally responsible disposal during the product life cycle.

WEEE compliance may not be required in your location for electrical & electronic equipment (EEE), nor may it be required for EEE designed and intended as fixed or temporary installation in transportation vehicles such as automobiles, aircraft, and boats. In some European Union member states, these vehicles are considered outside of the scope of the Directive, and EEE for those applications can be considered excluded from the WEEE Directive requirement.



This symbol (WEEE wheeie bin) on product indicates the product must not be disposed of with other household refuse. It must be disposed of and collected for recycling and recovery of waste EEE. Johnson Outdoors Marine Electronics, Inc. will mark all EEE products in accordance with the WEEE Directive. It is our goal to comply in the collection, treatment, recovery, and environmentally sound disposal of those products; however, these requirements do vary within European Union member states. For more information about where you should dispose of your waste equipment for recycling and recovery and/or your European Union member state requirements, please contact your dealer or distributor from which your product was purchased.

Contact Humminbird

Contact Humminbird Technical Support through our Help Center at <https://humminbird-help.johnsonoutdoors.com/hc/en-us> or in writing to the address below:

Humminbird Service Department
678 Humminbird Lane
Eufaula AL 36027 USA

Social Media Resources:



Facebook.com/HumminbirdElectronics



Twitter.com (@humminbirdfish)



Instagram.com/humminbirdfishing



YouTube.com/humminbirdtv

