

Eureka!

FOR LIFE OUTDOORS.

Assembly Instructions for the Hex Screen House:

You can usually assemble this screen house alone. However, with first time set-up or with windy conditions, you will need help.

Component List:

1 Screen/Body w/ Hub 1 Tent Bag 1 Pole Bag
6 Rafters 6 Poles 1 Stake Bag and Stakes

Layout the Parts

- Unpack the tent bag, pole bag and separate all of the components. Choose a suitable place and unroll and unfold the fabric with the Eureka! label up.
- Assemble all of the chain-corded poles and rafters. Check and make sure that each section is fully seated into the next. See fig.2.

Important: Locate the hub fitting attached to the center of the tent roof. Align the hub arms to match the layout of the corner pins without twisting the fabric. See fig.1.

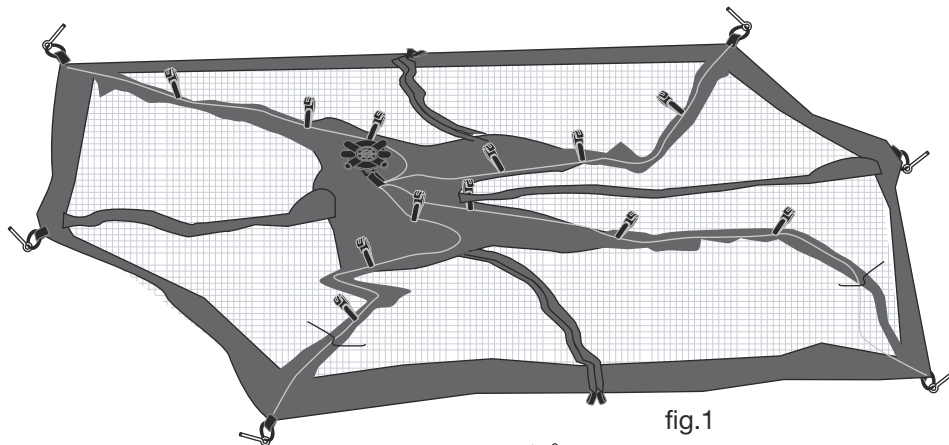

fig.2

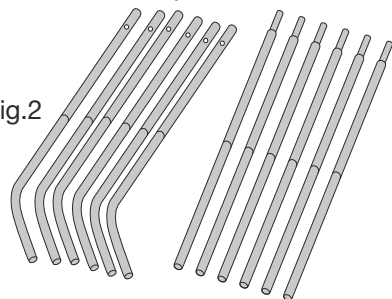
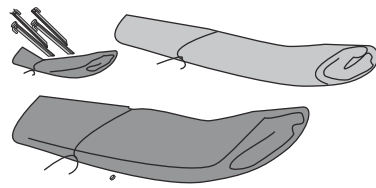
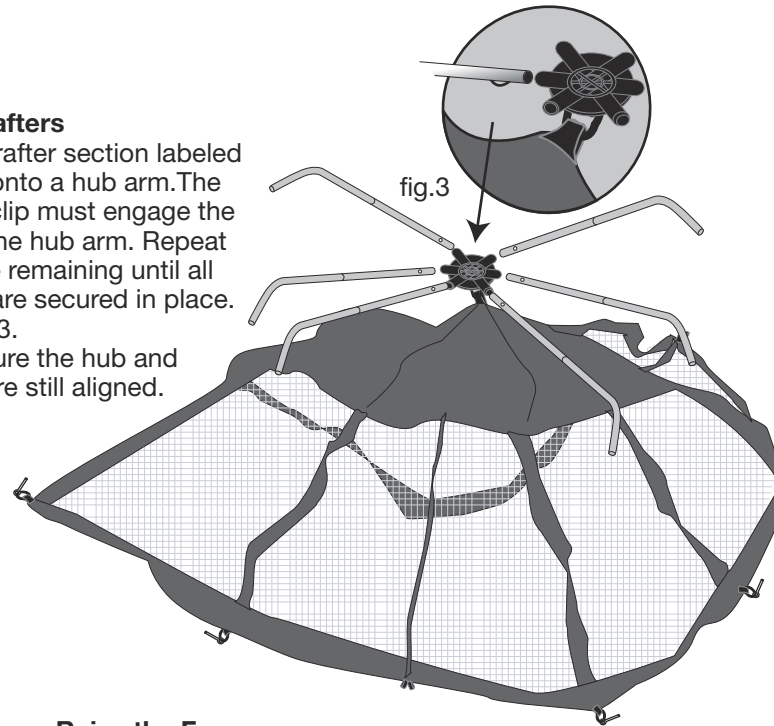

fig.1



Fit the Rafters

- Slide a rafter section labeled "TOP" onto a hub arm. The spring clip must engage the slot in the hub arm. Repeat with the remaining until all rafters are secured in place. See fig.3.
- Make sure the hub and fabric are still aligned.



Raise the Frame

- Insert the corner ring & pin into the bottom section of a pole. See fig.4. Then fit the top of the pole into the elbow of its corresponding rafter.
- With a second pole, fit it into the diagonal opposite rafter and pin to form an arch. Lift the arch, and working your way around the frame, attach the remaining poles to erect a free standing unit. See fig. 5.

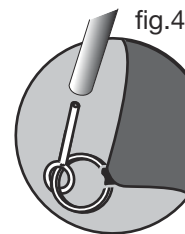

fig.4

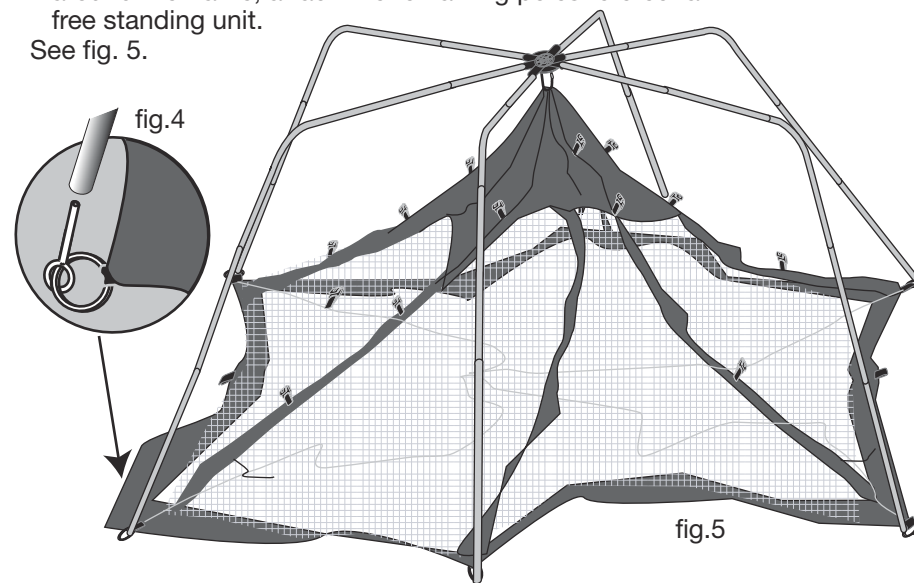
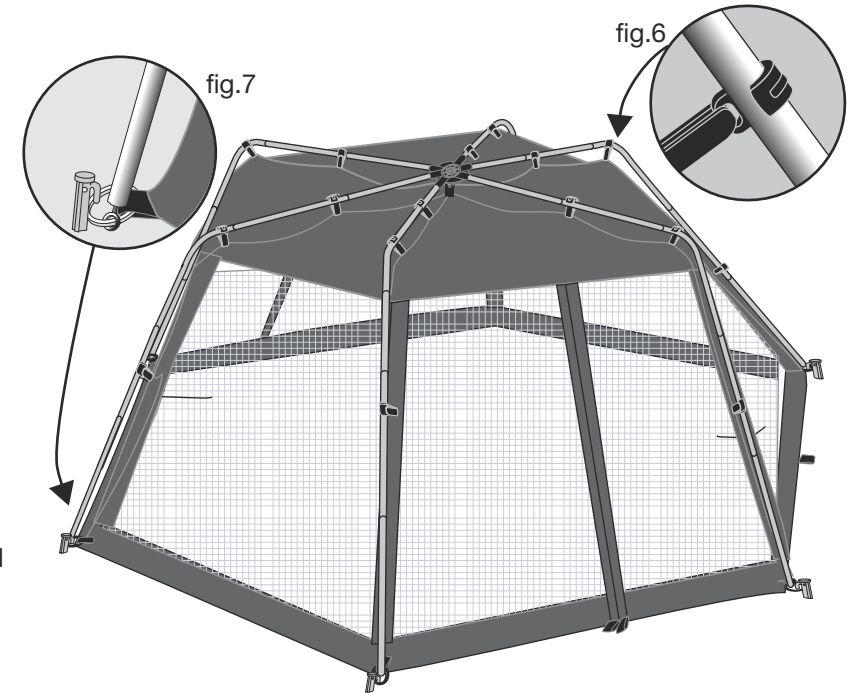

fig.5

Attach the Fabric to the Frame

- Attach all of the top pole clips first. It may be necessary to open the doors and step inside the shelter to reach the clips. Then, attach all side clips. See fig.6.
- Stake down all corner rings and your Screen House is ready. See fig.7.



Take down

- Zip the door closed.
- Unstake the screen house.
- Unclip the fabric from the frame.
- Remove the corner pins from the ends of the poles and remove from the rafters.
- Remove the rafters from the hub. Collapse the sections and store in the pole bag.
- Fold the fabric into thirds. Place the pole bag on the fabric and together, roll them up.
- Pack all components into the storage bag.

www.eurekatent.com
1.800.572.8822

LIMITED WARRANTY FOR THE STEEL POLE SHELTERS:

Johnson Outdoors Gear LLC Screen Houses are warranted to the original purchaser that they are free from major defects in materials or workmanship for three years, except as qualified below. We are not responsible for normal wear and tear or for damages caused by shipping, accidents, misuse, alterations, or improper installations. Additionally, although we manufacture Johnson Outdoors Gear LLC products with quality fabrics, we are not responsible for the negative effects of climate, pollution, acts of God, and long or semi-permanent installations. Because these shelters are temporary structures, it is necessary that any Johnson Outdoors Gear LLC shelter be installed and maintained according to the manufacturer's instructions.

What Johnson Outdoors Gear LLC Will Do:

If after inspection we find that a product failed due to a manufacturing or material defect, we will repair or replace the product, at our option, without charge.

How to Obtain Warranty Service:

Return the product, freight prepaid, to the Eureka! Dealer from whom it was purchased; or, contact Eureka's Customer Satisfaction Department for return authorization: toll free 1-800-572-8822. Collect shipments or shipments without return authorization cannot be accepted. The product registration card packaged with our product need not be returned for the warranty to be effective and for you to receive warranty service.

THERE ARE NO OTHER EXPRESS WARRANTIES BEYOND THE TERMS OF THIS LIMITED WARRANTY. IN NO EVENT SHALL JOHNSON OUTDOORS GEAR LLC BE LIABLE FOR INCIDENTAL OR CONSEQUENTIAL DAMAGES. Some states do not allow the exclusion or limitation of incidental or consequential damages, so the above limitation or exclusion may not apply to you.

How State Law Relates To This Warranty:

This warranty gives you specific legal rights, and you may have other rights that vary from state to state.



JOHNSON OUTDOORS GEAR LLC

CAUTION:

Good judgment and common sense must be used for each installation and take down. Since weather is unpredictable, it is the responsibility of the individual installing the shelter to determine the proper time and method to install, secure and dismantle the shelter. Johnson Outdoors Gear LLC shelter products are manufactured for use as temporary protection from sun and light rain. Evacuate the shelter in threatening or severe weather.

WARNING:

KEEP ALL FLAME AND HEAT SOURCES AWAY FROM THIS SHELTER FABRIC.

This shelter meets the flammability requirements of CPAI-84. The fabric may burn if left in continuous contact with any flame source. The application of any foreign substance to the fabric may render the flame-resistant properties ineffective.

GUYLINES:

Should winds or storms arise, do not count on staking alone to keep your shelter secure. It's important to put in the extra time to guying out. Correctly done, it can save your shelter during exceptional weather. Attach parachute cord [not provided] to the corner hooks and stake it to the ground three or four feet from the edge of the shelter.

ULTRAVIOLET LIGHT:

Ultraviolet light damage to the shelter fabric is caused by excessive exposure to sunlight. While our fabrics are UV resistant, any synthetic fabric is susceptible to UV degradation. UV damage will cause nylon and polyester to become brittle and tear easily. UV damage can be minimized by erecting shelters on sites with low exposure to direct sunlight.

CLEANING:

- Clean the shelter by setting it up and wiping it down with a mild soap (liquid hand soap) and lukewarm water solution. Rinse thoroughly and dry completely. Never use detergent, washing machines or dryers because they can damage the tent's protective coating and seams. After cleaning, be sure the shelter is completely dry, especially the heavier, double-stitched areas such as the seams, before storing or mold and mildew are likely to grow.
- Clean the poles with a cloth and lubricate them with silicone spray. This is especially necessary after ocean side camping trips to remove salt spray so the poles don't corrode or stay gritty.

ALTERATIONS OR MODIFICATIONS:

DO NOT misuse, modify or alter this product in any way from its condition at the time of sale. Alteration, modification or any use of this product contrary to the accompanying written instructions shall void the warranty. Moreover, any misuse, alteration or modification of the product shall absolve Johnson Outdoors Gear LLC of any liability for property damages or injuries sustained as a result of such misuse, modification or alteration.



LEAVE NO TRACE

Seven General Principles

1. PLAN AHEAD AND PREPARE
2. TRAVEL & CAMP ON DURABLE SURFACES
3. DISPOSE OF WASTE PROPERLY
4. LEAVE WHAT YOU FIND
5. MINIMIZE CAMPFIRE IMPACTS
6. RESPECT WILDLIFE
7. BE COURTEOUS OF OTHER VISITORS

To learn more...
WWW.LNT.ORG