

Transducer Switch

531870-1_E

Overview

Before you start installation, we encourage you to read these instructions carefully in order to get the full benefit from your Humminbird® accessory.

The Transducer Switch comes with all the necessary hardware to allow you to connect your control head to two transducers. The transducers may be the same type of transducer with different mounting locations, or you can maximize your unit's performance by using two different transducers. The switch is intended for installation on the console, and will work well on almost any boat.

Customer Service: If you find that any items are missing from your installation kit, visit our Web site at humminbird.com or call Customer Service at **1-800-633-1468**.

Supplies: In addition to the hardware supplied with your Transducer Switch, you will need a hand drill with various size bits, a Phillips screwdriver, an adjustable wrench, and a 3 Amp fuse.

Installation

Perform the procedures in the following sections to install the Transducer Switch on your boat. Before installing the Transducer Switch, gather all the parts you will need, and make sure that the planned location of the Transducer Switch will allow you to connect the two transducers to your control head.

1. Locate the Transducer Switch Mounting Position

There are two ways to find the mounting location, as follows:

- **Switch Panel:** If your console already contains a switch panel with an available slot, slide the Transducer Switch into the designated slot until it snaps into place. Proceed to procedure two.
- **In-Dash:** If your console does not have a switch panel or a pre-made mounting location, you will need to create one yourself.

Manually create a mounting location:

1. **Mounting Requirements:** Locate a suitable, flat area of the dash to mount the Transducer Switch. The switch requires a depth of at least 1.5 inches (38.1 millimeters). Make sure that it will be positioned near your control head on the console of the boat, within reach of the cables for both transducers. Also, make sure you have access behind the panel in order to attach the cables.
2. Tape the template (included) over the desired in-dash mounting location.
3. At a location inside the dotted line on the template, drill a hole large enough to insert the blade of the reciprocating saw. Carefully begin cutting toward the dotted line, then follow the dotted line around the template. Remove the template when finished.
4. Insert the end of the switch through the hole until it snaps securely in place.

2. Connect the Transducers and the Control Head to the Switch

To connect your Transducer Switch to your control head, you may have to remove the control head from the mounting bracket and temporarily disassemble the connector holder or cable tray (depending on your control head model).

NOTE: Your connector holder hardware may be different than the illustration, depending on your Humminbird model. See your control head installation guide for details.

CAUTION! Do NOT mount the cables where the connectors could be submerged in water or flooded. If cables are installed in a splash-prone area, it may be helpful to apply dielectric grease to the inside of the connectors to prevent corrosion. Dielectric grease can be purchased separately from a general hardware or automotive store.

CAUTION! Do not cut or shorten the transducer cables, and try not to damage the cable insulation. Route the cable as far as possible from any VHF radio antenna cables or tachometer cables to reduce the possibility of interference. If the cable is too short, extension cables are available to extend the transducer cable up to a total of 50 feet. For assistance, contact Customer Service.

Transducer Switch

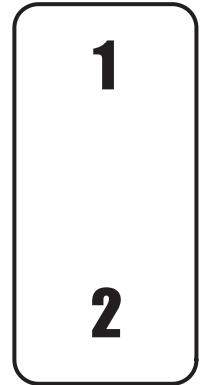

Mounting the Switch

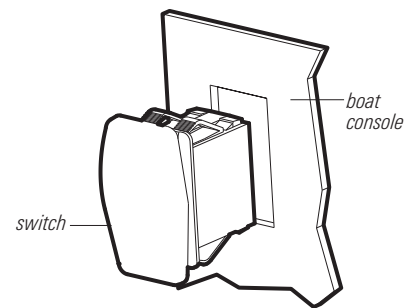

Transducer Switch

531870-1_E

Connect the transducers to the Transducer Switch:

1. Access your transducer cables and insert each transducer cable connector into a Transducer Switch connector until you hear it click into place. Refer to the illustration for guidance.

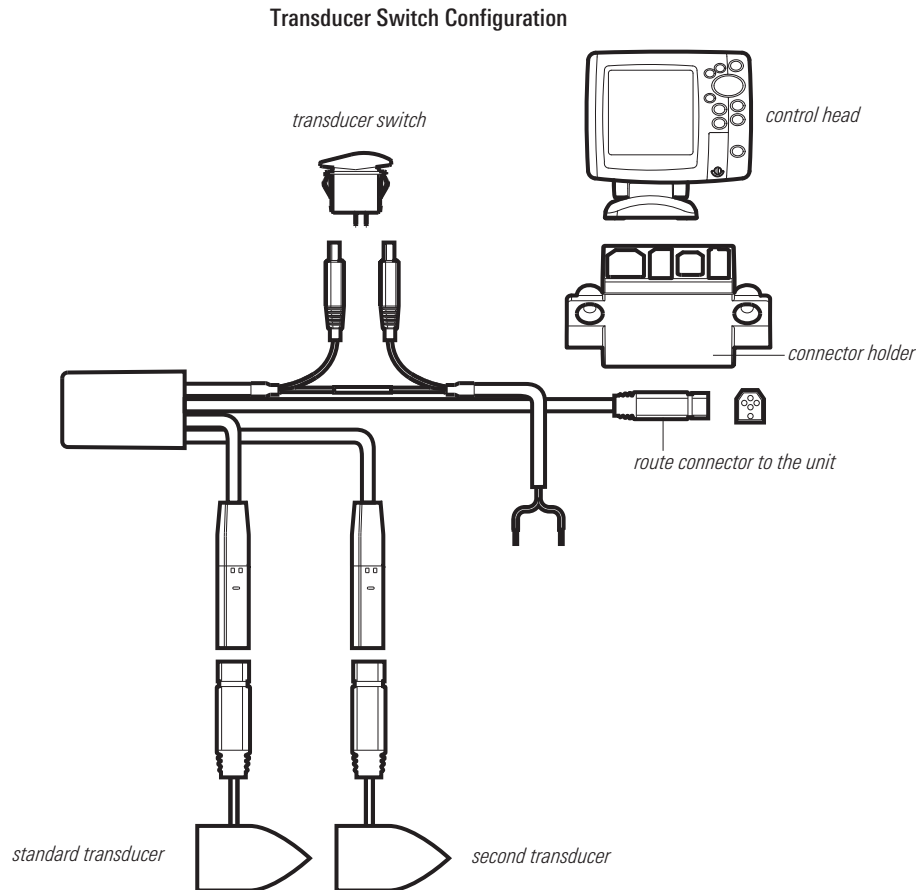

NOTE: Use caution while sliding the transducer connectors into the Transducer Switch connectors. The slots for the connectors are keyed to prevent reversed installation, so do not force the connectors together. See your control head installation guide for additional information.

Connect the connector clips to the Transducer Switch:

1. From the back side of the panel, plug the two connector clips from the switch assembly into the two outlets of the Transducer Switch.

NOTE: Connecting the connector clips to the Transducer Switch does not require a specific order; either connector will work with either outlet.

Connect the control head to the Transducer Switch:

1. Remove the connector holder from your control head.
2. Insert the Transducer Switch cable connector into the transducer slot of the connector holder.

NOTE: The slots are keyed to prevent reversed installation, so be careful not to force the connector into the holder. See your control head installation guide for additional information.

700 Series™ with Ethernet NOTE: If you are installing the Speed Sensor accessory (optional), insert the Sonar/Speed Y-Cable connector into the transducer slot on the connector holder. Then, connect the transducer connector and speed sensor connector to the corresponding connectors on the Y-Cable. The Y-Cable requires a separate purchase. Contact Customer Service for details.

Connecting the Connector Clips to the Transducer Switch

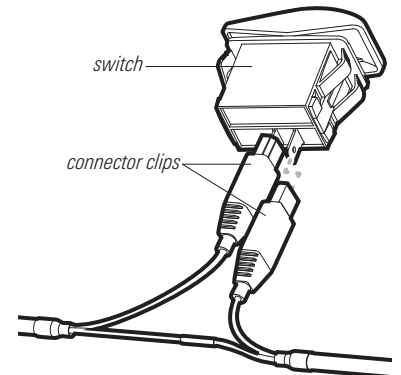

Inserting the Cable Connector

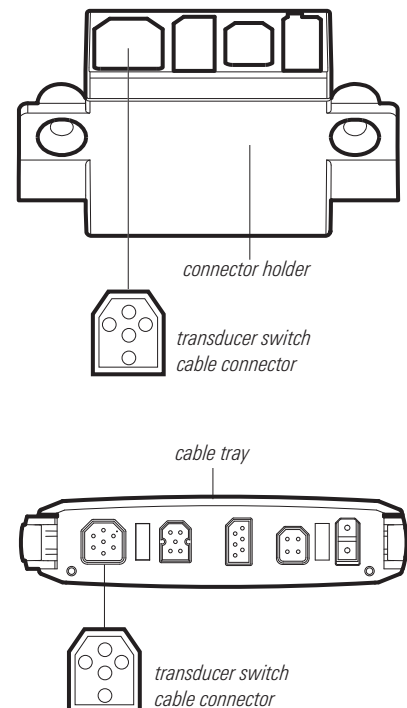

Transducer Switch

3. Connect the Power Cable

Connect the Transducer Switch power cable to the boat's fuse panel (usually located near the console) or directly to the battery. If you must connect to a battery, connect to a battery switch (not included).

WARNING! Humminbird is not responsible for over-voltage or over-current failures. The control head must have adequate protection through the proper selection and installation of a 3 Amp fuse.

- 1a. **Fuse Terminal Connection:** Use crimp-on type electrical connectors (not included) that match the terminal on the fuse panel. Attach the black wire to ground (-), and the red wire to positive (+) 12 VDC power. Install a 3 Amp fuse (not included) for protection of the unit.

or...

- 1b. **Battery Connection:** Install an inline fuse holder (not included) and a 3 Amp fuse (not included) for the protection of the unit, and a battery switch (not included). Install the battery switch using the instructions provided with it. Attach the black wire to ground (-), and the red wire to positive (+) 12 VDC power.

NOTE: If you are unable to obtain a battery switch and are forced to connect the power cable directly to the battery, be aware that this may cause a slow loss of power over time. See procedure five, **Power Off**.

2. Secure the installation with cable ties (optional).

Your Transducer Switch is now ready for operation.

4. Activate a Transducer

Perform the following procedures to alternate between the transducers connected to your Transducer Switch.

Activate a transducer:

1. Press the Transducer Switch to select the desired transducer.
2. Turn on your control head.
3. In any view, press the MENU key twice to open the Main Menu.
4. Press the RIGHT or LEFT Cursor keys to highlight the **Sonar** menu tab.
5. Press the DOWN Cursor key to select **Transducer Select**.

NOTE: This feature may appear as either *Transducer Select* or *Connected Transducer*, depending on your model.

6. Press the RIGHT or LEFT Cursor keys to select a transducer.

Connecting to a Fuse Panel

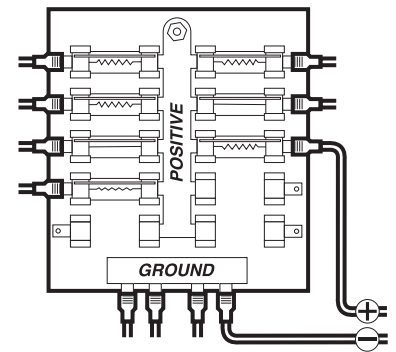

Changing Transducers in the Menu System

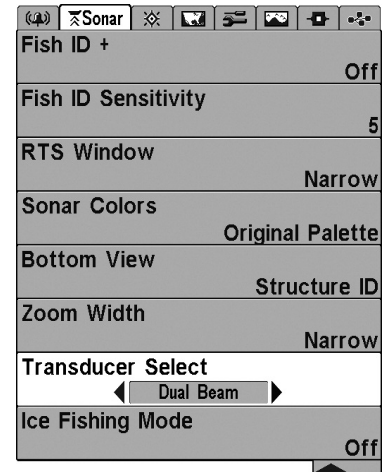

Sonar Menu

Transducer Switch

531870-1_E

5. Power Off

It is important to make sure all accessories (switches, control heads, etc.) are powered off in order to avoid possibly draining the battery. To make sure your Transducer Switch is disengaged, follow the steps below.

If your Transducer Switch is connected to the fuse panel:

1. Power off your boat to disengage the switch.

If your Transducer Switch is connected to a battery switch:

1. Turn the dial of the battery switch to the OFF position.

If your Transducer Switch is connected directly to a battery:

1. Power off your boat.
2. Remove the Transducer Switch wires from the battery.

Contact Humminbird

Web site	humminbird.com
E-mail	service@humminbird.com
Telephone	1-800-633-1468
Direct Shipping	Humminbird Service Department 678 Humminbird Lane Eufaula, AL 36027 USA

WARNING! This device should not be used as a navigational aid to prevent collision, grounding, boat damage, or personal injury. When the boat is moving, water depth may change too quickly to allow time for you to react. Always operate the boat at very slow speeds if you suspect shallow water or submerged objects.

WARNING! Disassembly and repair of this electronic unit should only be performed by authorized service personnel. Any modification of the serial number or attempt to repair the original equipment or accessories by unauthorized individuals will void the warranty.

ENVIRONMENTAL COMPLIANCE STATEMENT: It is the intention of Johnson Outdoors Marine Electronics, Inc. to be a responsible corporate citizen, operating in compliance with known and applicable environmental regulations, and a good neighbor in the communities where we make or sell our products.

WEEE Directive: EU Directive 2002/96/EC "Waste of Electrical and Electronic Equipment Directive (WEEE)" impacts most distributors, sellers, and manufacturers of consumer electronics in the European Union. The WEEE Directive requires the producer of consumer electronics to take responsibility for the management of waste from their products to achieve environmentally responsible disposal during the product life cycle.

WEEE compliance may not be required in your location for electrical & electronic equipment (EEE), nor may it be required for EEE designed and intended as fixed or temporary installation in transportation vehicles such as automobiles, aircraft, and boats. In some European Union member states, these vehicles are considered outside of the scope of the Directive, and EEE for those applications can be considered excluded from the WEEE Directive requirement.



This symbol (WEEE wheelie bin) on product indicates the product must not be disposed of with other household refuse. It must be disposed of and collected for recycling and recovery of waste EEE. Johnson Outdoors Marine Electronics, Inc. will mark all EEE products in accordance with the WEEE Directive. It is our goal to comply in the collection, treatment, recovery, and environmentally sound disposal of those products; however, these requirements do vary within European Union member states. For more information about where you should dispose of your waste equipment for recycling and recovery and/or your European Union member state requirements, please contact your dealer or distributor from which your product was purchased.