



ULTERRA® QUEST™

BOW-MOUNT TROLLING MOTOR

Owner's Manual

INSTALLATION

THANK YOU

Thank you for choosing Minn Kota. We believe that you should spend more time fishing and less time positioning your boat. That's why we build the smartest, toughest, most intuitive trolling motors on the water. Every aspect of a Minn Kota trolling motor is thought out and rethought until it's good enough to bear our name. Countless hours of research and testing provide you the Minn Kota advantage that can truly take you "Anywhere. Anytime." We don't believe in shortcuts. We are Minn Kota. And we are never done helping you catch more fish.

REGISTRATION

Remember to keep your receipt and immediately register your trolling motor on our website at minnkota.johnsonoutdoors.com/us/register.

SERIAL NUMBER

Your Minn Kota 11-character serial number is very important. It helps to determine the specific model and year of manufacture. When contacting Consumer Service or registering your product, you will need to know your product's serial number.

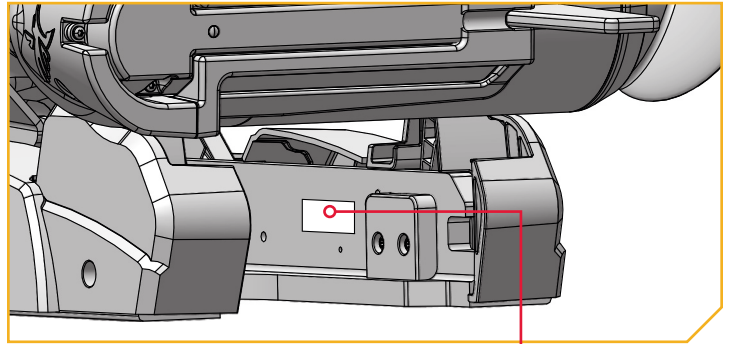

NOTICE: The serial number for the Ultrera QUEST is located on the inside of the Mount, behind the left Motor Ramp.

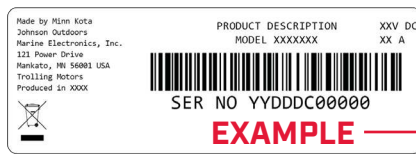

MOTOR INFORMATION (For Consumer Reference Only)

Model: _____

Serial Number: _____

Purchase Date: _____

Store Where Purchased: _____

NOTICE: Do not return your Minn Kota motor to your retailer. Your retailer is not authorized to repair or replace this unit. You may obtain service by: calling Minn Kota at (800) 227-6433; returning your motor to the Minn Kota Factory Service Center; sending or taking your motor to any Minn Kota authorized service center. A list of authorized service centers is available on our website at minnkota.johnsonoutdoors.com. Please include proof of purchase, serial number and purchase date for warranty service with any of the above options.

Made for iPhone® 11 and iPhone X

For updated iOS, Humminbird® and Minn Kota® compatibility, visit minnkota.johnsonoutdoors.com



Use of the Made for Apple badge means that an accessory has been designed to connect specifically to the Apple product(s) identified in the badge, and has been certified by the developer to meet Apple performance standards. Apple is not responsible for the operation of this device or its compliance with safety and regulatory standards. iPhone is a trademark of Apple Inc., registered in the U.S. and other countries. The trademark "iPhone" is used in Japan with a license from Aiphone K.K.

Android™ is a trademark of Google LLC. The Android robot is reproduced or modified from work created and shared by Google and used according to terms described in the Creative Commons 3.0 Attribution License.

TABLE OF CONTENTS

SAFETY CONSIDERATIONS	4	MOTOR WIRING DIAGRAM	56
WARRANTY	5	USING & ADJUSTING THE MOTOR	57
KNOW YOUR BOAT	6	Mount Features	57
FEATURES	7	Indicator Panel	58
INSTALLATION	8	Stowing and Deploying the Ulterra QUEST	59
Installation Parts List	8	Battery Monitoring	59
Mounting Considerations	9	Stowing and Deploying with the Wireless Remote.....	59
Tools and Resources Required	9	Stowing and Deploying with the	
Installing the Ulterra QUEST	10	One-Boat Network (OBN) App	62
BATTERY & WIRING INSTALLATION	15	Stowing and Deploying with the Foot Pedal	64
Boat Rigging & Product Installation.....	15	Adjusting the Depth (Trim) of the Ulterra QUEST	65
Conductor Gauge and Circuit Breaker Sizing Table	15	Trimming with the Wireless Remote	65
Selecting the Correct Batteries	16	Trimming with the OBN App.....	67
Additional Considerations	16	Trimming with the Foot Pedal.....	68
Connecting the Batteries in Series.....	17	Motor Adjustments	69
24-Volt Systems	17	Adjusting the Lift Belt	69
36-Volt Systems	18	Greasing the Tilt Shaft and Latch Pin	70
COMPLETING THE INSTALLATION	19	Installing an External Transducer	71
Verifying Power.....	19	Emergency Stow Procedures	72
Installing the Bow-Mount Stabilizer	19	Stowing from the Mount	72
Powering on the Wireless Remote	20	Manual Stow Bypass	72
Installing the Foot Pedal.....	21	Manually Trim the Motor	73
Identifying Trolling Motor Features		Manually Stow the Motor	74
and their Associated Cables	22	Manual Stow Bypass Recovery	75
Feature & Cable Management.....	23	USING THE FOOT PEDAL	77
Dual Spectrum CHIRP	23	Modes	77
Built-in MEGA Side Imaging.....	28	Foot Pedal Operation	78
Advanced GPS Navigation.....	32	AutoPilot	81
Securing Accessory Cables.....	37	Waypoints.....	83
Installing the Prop.....	39	Shallow Water Anchor.....	85
ONE-BOAT NETWORK	40	Spot-Lock.....	87
Optimizing the Performance of the Ulterra QUEST		SERVICE & MAINTENANCE	89
with the Wireless Remote or One-Boat Network App	40	Prop Replacement.....	89
One-Boat Network Adjustments.....	41	General Maintenance.....	90
Keel Offset	41	Troubleshooting.....	91
Straight On Deploy	45	COMPLIANCE STATEMENTS	93
Stow Orientation	47	PARTS DIAGRAM & PARTS LIST	95
Boat Scale	49		
One-Boat Network Buttons.....	51		
Customizing the One-Boat Network Buttons			
on the Wireless Remote.....	51		
Customizing the One-Boat Network Button			
on the Foot Pedal	54		

SAFETY CONSIDERATIONS

Please thoroughly read the user manual. Follow all instructions and heed all safety and cautionary notices. Use of this motor is only permitted for persons that have read and understood these user instructions. Minors may use this motor only under adult supervision.

WARNING

You are responsible for the safe and prudent operation of your vessel. We have designed your Minn Kota product to be an accurate and reliable tool that will enhance boat operation and improve your ability to catch fish. This product does not relieve you from the responsibility for safe operation of your boat. You must avoid hazards to navigation and always maintain a permanent watch so you can respond to situations as they develop. You must always be prepared to regain manual control of your boat. Learn to operate your Minn Kota product in an area free from hazards and obstacles.

WARNING

Never run the motor out of the water, as this may result in injuries from the rotating propeller. The motor should be disconnected from the power source when it is not in use or is off the water. When connecting the power-supply cables of the motor to the battery, ensure that they are not kinked or subject to chafe and route them in such a way that persons cannot trip over them. Before using the motor make sure that the insulation of the power cables is not damaged. Disregarding these safety precautions may result in electric shorts of battery(s) and/or motor. Always disconnect motor from battery(s) before cleaning or checking the propeller. Avoid submerging the complete motor as water may enter the lower unit through control head and shaft. If the motor is used while water is present in the lower unit considerable damage to the motor can occur. This damage will not be covered by warranty.

WARNING

Take care that neither you nor other persons approach the turning propeller too closely, neither with body parts nor with objects. The motor is powerful and may endanger or injure you or others. While the motor is running watch out for persons swimming and for floating objects. Persons whose ability to run the motor or whose reactions are impaired by alcohol, drugs, medication, or other substances are not permitted to use this motor. This motor is not suitable for use in strong currents. The constant noise pressure level of the motor during use is less than 70dB(A). The overall vibration level does not exceed 2,5 m/sec².

WARNING

When stowing or deploying the motor, keep fingers clear of all hinge and pivot points and all moving parts. In the event of unexpected operation, remove power leads from the battery.

WARNING

It is recommended to only use Johnson Outdoors approved accessories with your Minn Kota motor. Using non-approved accessories including to mount or control your motor may cause damage, unexpected motor operation and injury. Be sure to use the product and approved accessories, including remotes, safely and in the manner directed to avoid accidental or unexpected motor operation. Keep all factory installed parts in place including motor and accessory covers, enclosures and guards.

WARRANTY

WARRANTY ON MINN KOTA FRESHWATER TROLLING MOTORS

Minn Kota Freshwater Trolling Motors - Limited Lifetime Warranty On Composite Shaft And Limited Two-Year Warranty On The Entire Product

Johnson Outdoors Marine Electronics, Inc. ("JOME") extends the following limited warranty to the original retail purchaser only. Warranty coverage is not transferable.

Minn Kota Limited Two-Year Warranty on the Entire Product

JOME warrants to the original retail purchaser only that the purchaser's new Minn Kota freshwater trolling motor will be materially free from defects in materials and workmanship appearing within two (2) years after the date of purchase. JOME will (at its option) either repair or replace, free of charge, any parts found by JOME to be defective during the term of this warranty. Such repair, or replacement shall be the sole and exclusive liability of JOME and the sole and exclusive remedy of the purchaser for breach of this warranty.

Minn Kota Limited Lifetime Warranty on the Composite Shaft

JOME warrants to the original retail purchaser only that the composite shaft of the purchaser's Minn Kota trolling motor will be materially free from defects in materials and workmanship appearing within the original purchaser's lifetime. JOME will provide a new composite shaft, free of charge, to replace any composite shaft found by JOME to be defective during the term of this warranty. Providing a new composite shaft shall be the sole and exclusive liability of JOME and the sole and exclusive remedy of the purchaser for breach of this warranty; and purchaser shall be responsible for installing, or for the cost of labor to install, any new composite shaft provided by JOME.

Exclusions and Limitations

This limited warranty does not apply to products that have been used in saltwater or brackish water, commercially or for rental purposes. This limited warranty does not cover normal wear and tear, blemishes that do not affect the operation of the product, or damage caused by accidents, abuse, alteration, modification, shipping damages, acts of God, negligence of the user or misuse, improper or insufficient care or maintenance. **DAMAGE CAUSED BY THE USE OF OTHER REPLACEMENT PARTS NOT MEETING THE DESIGN SPECIFICATIONS OF THE ORIGINAL PARTS WILL NOT BE COVERED BY THIS LIMITED WARRANTY.** The cost of normal maintenance or replacement parts which are not in breach of the limited warranty are the responsibility of the purchaser. Prior to using products, the purchaser shall determine the suitability of the products for the intended use and assumes all related risk and liability. Any assistance JOME provides to or procures for the purchaser outside the terms, limitations or exclusions of this limited warranty will not constitute a waiver of the terms, limitations or exclusions, nor will such assistance extend or revive the warranty. JOME will not reimburse the purchaser for any expenses incurred by the purchaser in repairing, correcting or replacing any defective products or parts, except those incurred with JOME's prior written permission. **JOME'S AGGREGATE LIABILITY WITH RESPECT TO COVERED PRODUCTS IS LIMITED TO AN AMOUNT EQUAL TO THE PURCHASER'S ORIGINAL PURCHASE PRICE PAID FOR SUCH PRODUCT.**

Minn Kota Service Information

To obtain warranty service in the U.S., the product believed to be defective, and proof of original purchase (including the date of purchase), must be presented to a Minn Kota Authorized Service Center. Go to minnkota.johnsonoutdoors.com/us/support/service-providers/locate to find a Minn Kota Authorized Service Center. Any charges incurred for service calls, transportation or shipping/freight to/from the Minn Kota Authorized Service Center, labor to haul out, remove, re-install or re-rig products removed for warranty service, or any other similar items are the sole and exclusive responsibility of the purchaser. Products purchased outside of the U.S. must be returned prepaid with proof of purchase (including the date of purchase and serial number) to any Authorized Minn Kota Service Center in the country of purchase. To contact Minn Kota Customer Service go to minnkota-help.johnsonoutdoors.com/hc/en-us. Products repaired or replaced will be warranted for the remainder of the original warranty period, or for 90 days from the date of repair or replacement, whichever is longer. For any product that is returned for warranty service that JOME finds to be not covered by or not in breach of this limited warranty, there will be a billing for services rendered at the prevailing labor rate of the applicable Minn Kota Authorized Service Center and for a minimum of at least one hour.

Service Provider
Locator



Contact Customer
Service



NOTICE: Do not return your Minn Kota product to your retailer. Your retailer is not authorized to repair or replace products.

NOTICE: THERE ARE NO EXPRESS WARRANTIES OTHER THAN THESE LIMITED WARRANTIES. IN NO EVENT SHALL ANY IMPLIED WARRANTIES INCLUDING ANY IMPLIED WARRANTIES OF MERCHANTABILITY OR FITNESS FOR PARTICULAR PURPOSE, EXTEND BEYOND THE DURATION OF THE RELEVANT EXPRESS LIMITED WARRANTY. IN NO EVENT SHALL JOME BE LIABLE FOR PUNITIVE, INDIRECT, INCIDENTAL, CONSEQUENTIAL OR SPECIAL DAMAGES. Without limiting the foregoing, JOME assumes no responsibility for loss of use of product, loss of time, inconvenience or other damage.

Some states do not allow limitations on how long an implied warranty lasts or the exclusion or limitation of incidental or consequential damages, so the above limitations and/or exclusions may not apply to you. This warranty gives you specific legal rights and you may also have other legal rights which vary from state to state.

KNOW YOUR BOAT

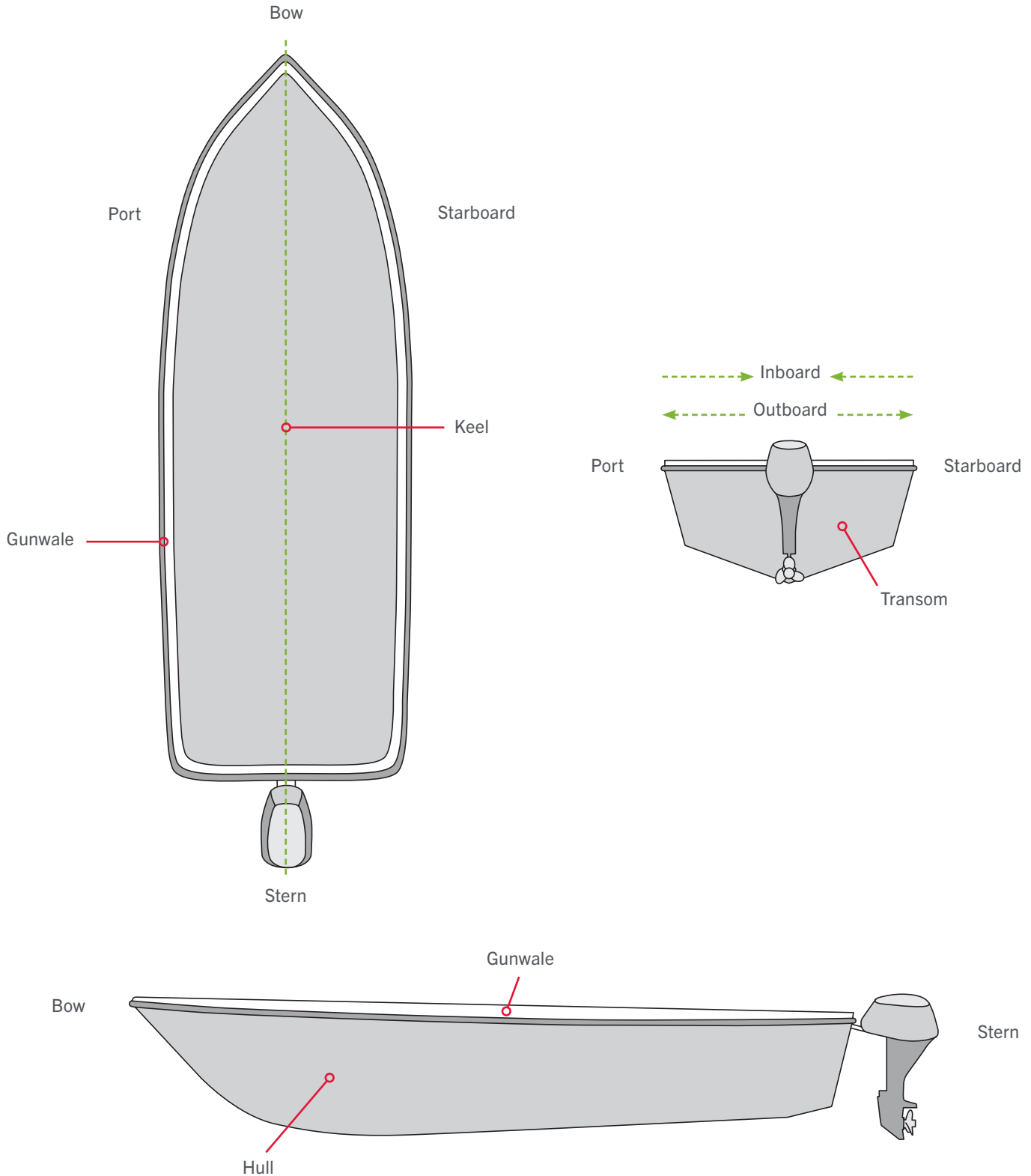

FEATURES

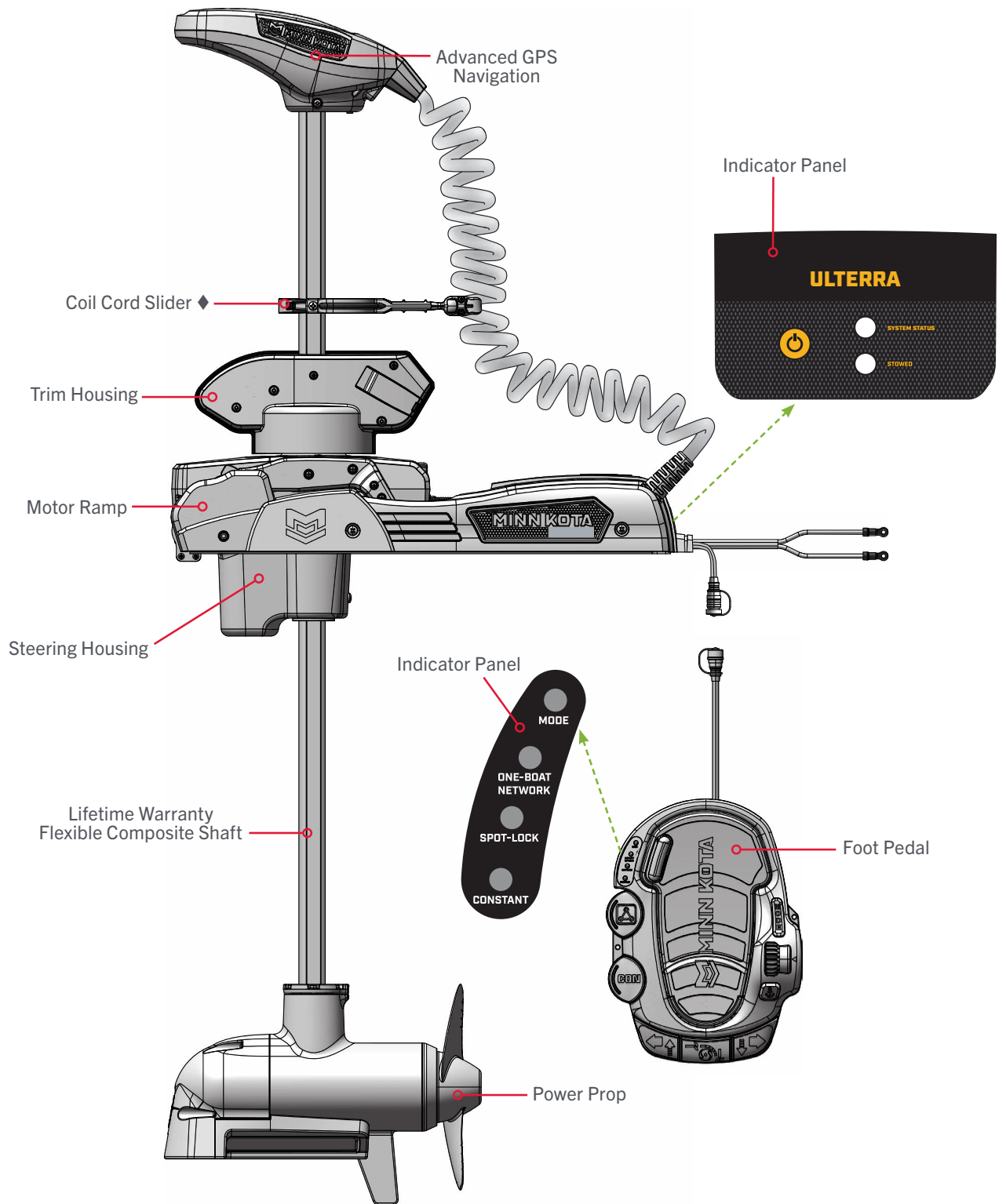

◆ Only on models with a 72" shaft length.

NOTICE: Specifications subject to change without notice. This diagram is for reference only and may differ from your actual motor.

INSTALLATION

INSTALLING THE ULTERRA QUEST

Your new Ulterra QUEST comes with everything you'll need to install it directly to the boat. The motor can be mounted directly to the bow or coupled with a Minn Kota quick release bracket for ease of mounting and removal. For compatible quick release brackets and to locate your nearest dealer, visit minnkota.johnsonoutdoors.com. To install the motor directly to the boat, follow the instructions provided in this manual. Please review the parts list, mounting considerations and tools needed for installation prior to getting started. For additional product support, visit minnkota.johnsonoutdoors.com.

INSTALLATION PARTS LIST

Item / Assembly	Part #	Description	Qty.
A (Includes 1-5)	2994948	BAG ASM, INSTINCT, T3 BL HDW	1
1	2323440	SCREW-3/8-16 X 2 1/2 HHCS SS	6
2	2383122	NUT 3/8-16 NYLON INST LOCKNUT	6
3	2321710	WASHER, RUBBER MOUNT	6
4	2371796	BACKUP BAR 3/16 X 1 X 2	6
5	2378608	ANTI SEIZE TUBE, 4CC, TALON	1
6	✘	MOTOR ASSEMBLY	1
7	2390802	LANYARD w/CARABINER IP RMT U2	1
8	411690-1	TROLLING MOTOR REMOTE	1
9	2992371	STABILIZER, BWMT ES TM ASM *72**	1
10	2321170	PROP, POWER REAMED	1
B (Includes 11-13)	2992604	BAG ASSM, PROP HARDWARE	1
11	2091701	WASHER-PROP (LARGE) MAX101	1
12	2093101	NUT-PROP, NYLOC, LG, MX101 3/8 SS	1
13	2262659	PIN-DRIVE 1" X 3/16 SS 17-4	1
C	2994742	FT PED ASM, ULTERRA QUEST	1
D (Includes 14)	2994859	BAG ASY-TERROVA/V2, RUB. BUMPERS	1
14	2325110	PAD, FOOT PEDAL PD	5
15	490637-4	CABLE, ETH, M12-M12, BRAID, 30'	1
16	490380-1	CABLE, ETHERNET PIGTAIL-700 HD	1
17	2206301	TIE WRAP, LOW PROFILE 8"	1
18	2994961	BAG ASM, CABLE, ADPTR, 490537-2 *490537-2* *MKR-MI-1* *DSC* *MSI*	1
E (Includes 19)	2994955	BAG ASM, MKA-60 STABILIZER *72**	1
19	2383475	SCREW-#8-18x1 1/2 L SELF DRILL SS *72**	4
▲	2207124	MANUAL, ULTERRA	1
▲	2207125	MANUAL, INSTL GD, ULTERRA	1
▲	2207126	QK REF GUIDE, ULT Q/INST Q	1
▲	2397110	MANUAL, WIRELESS REMOTE	1
▲	2397115	GUIDE-QCK REFERENCE IP 4.0	1
▲	2294950	INSTRUCTIONS, OBN & REMOTE PAIR	1
▲	2207130	BRUSHLESS QS SETUP GUIDE	1
▲	2377179	INSTR. SHEET, MKA-60 STBLZR *72**	1

▲ Not shown on Parts Diagram.

✘ This part is included in an assembly and cannot be ordered individually.

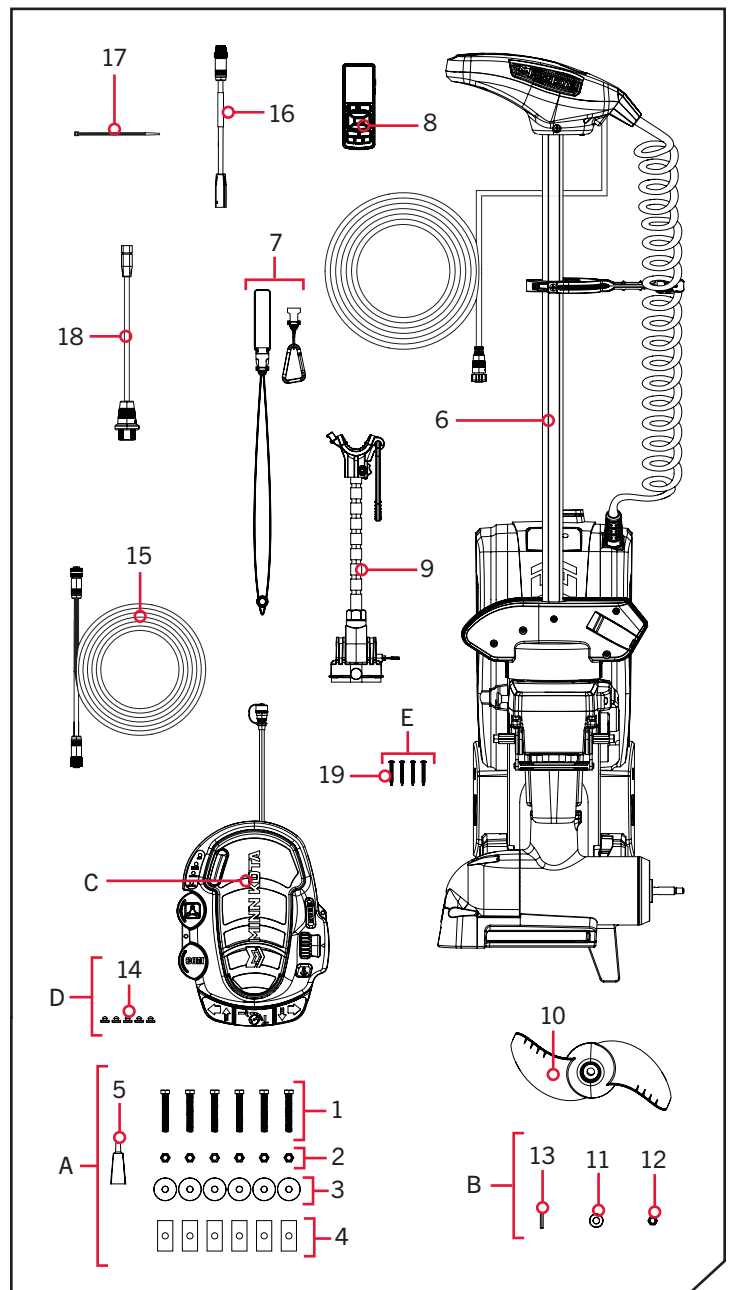

MOUNTING CONSIDERATIONS



MOUNTING CONSIDERATIONS

It is recommended that the motor be mounted as close to the centerline or keel of the boat as possible. Make sure the area under the mounting location is clear to drill holes and install hardware. The mounting surface for the Ulterra QUEST must be flat. Rubber washers can be used to shim the base extrusion flat before hardware is tightened.

The motor must not encounter any obstructions as it is lowered into the water or raised into the boat when stowed and deployed. When stowed, ensure that there is enough room for the Shaft and Control Head and that they do not extend off the side of the boat.



View accessories available for your trolling motor at minnkota.johnsonoutdoors.com.

All six mounting holes must be used when securing the Ulterra QUEST to the boat deck. If the desired mounting location does not allow for all six mounting holes and mounting bolts, a Boat Deck Reinforcement Kit (1854058) should be used or a new mounting location selected. Consider a quick release bracket with the installation of your motor.

Mounting options for the Ulterra QUEST include:

1. Installing the motor directly to the boat deck
2. Mounting the motor with an MKA-58 Boat Deck Reinforcement Kit (1854058)
3. Mounting the motor with an MKA-56/RTA-55 composite quick release bracket (1854056 - black/1854055 - white) or an MKA-57 sliding quick release bracket (1854057)
4. Combining an MKA-58 Boat Deck Reinforcement Kit and an MKA-56/RTA-55 Quick Release Bracket with the Ulterra QUEST

When mounting the Ulterra QUEST directly to the boat, follow the installation instructions outlined in this manual. If an accessory bracket will be used to mount the Ulterra QUEST, follow the installation instructions provided with the mounting accessory. To view a list of compatible accessories, visit minnkota.johnsonoutdoors.com.

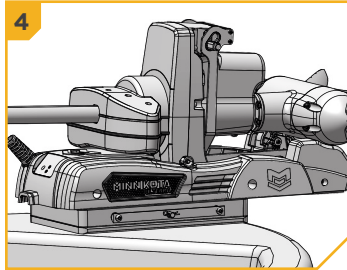
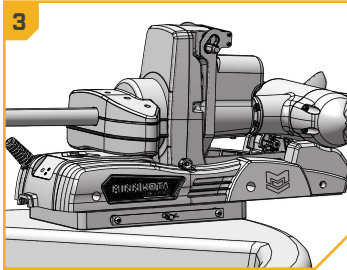
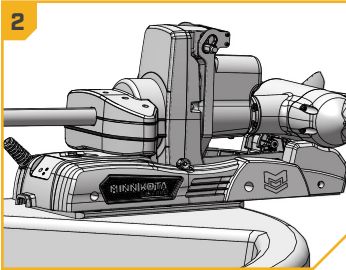
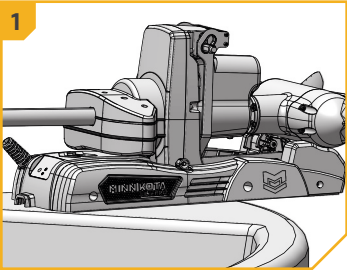

TOOLS AND RESOURCES REQUIRED

- #3 Phillips Screwdriver
- Drill
- 3/8" Drill Bit
- Awl or similar marking tool
- 9/16" Open/Box End Wrench
- 9/16" Deep Well Socket
- A second person to help with the installation



INSTALLING THE ULTRERA QUEST

INSTALLATION >

INSTALLING THE ULTRERA QUEST

1

ITEM(S) NEEDED

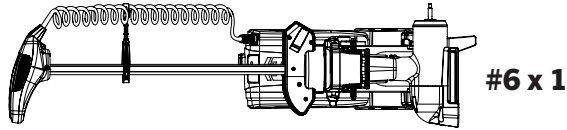

- Place the trolling motor (Item #6) on an elevated, level surface, such as a workbench or the tailgate of a pickup. The motor, as removed from the box, should be in the stowed position.
- Make sure that the Power Cables from the battery are disconnected or that the breaker, if equipped, is "off."

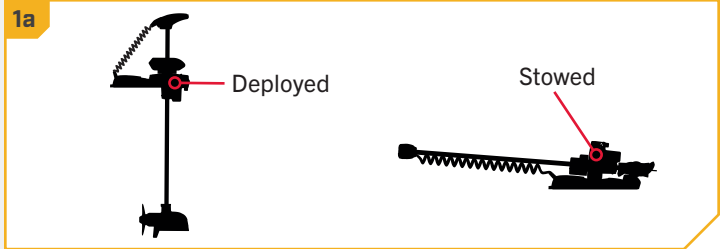

WARNING

Make sure the motor is on a level surface and is not connected to a power source.

NOTICE: The trolling motor weighs up to 90lb. Minn Kota recommends having a second person help with the installation.

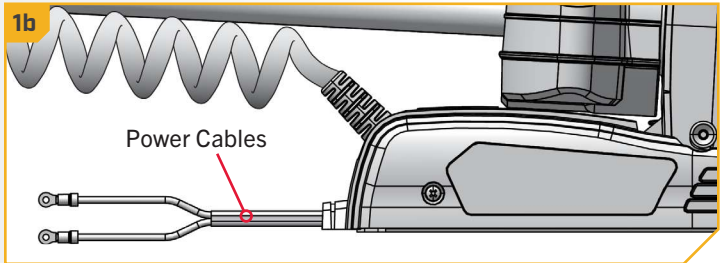

2

- Remove the four Sideplate Screws using a #3 Phillips Screwdriver. Two of these screws will be located on each side of the mount.
- Remove the Right Sideplate and the Left Sideplate to expose the six mounting holes in the Base Extrusion.

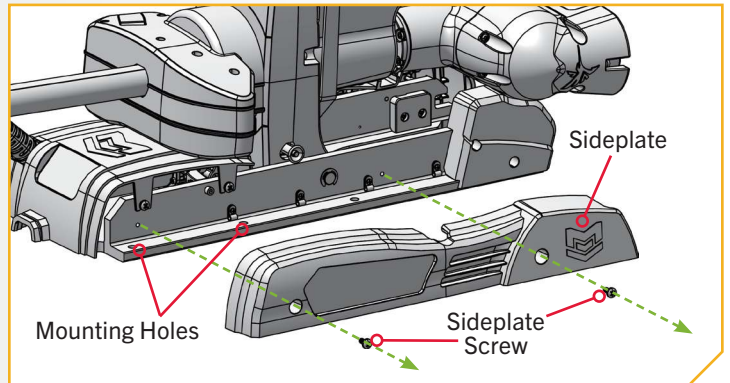

INSTALLING THE ULTERRA QUEST

3

- e. Review the mounting considerations at the beginning of the Installation section for proper clearance. Place the motor on the bow of the boat at the intended mounting location, as close to the centerline or keel as possible. Ensure there is enough room for the Shaft and Control Head and that they do not extend off the side of the boat. The motor can be installed on either the Port or Starboard side of the bow, based on personal preference.
- f. Position the motor so that the Slot in the Base Extrusion is positioned beyond the boat Gunwale. For proper clearance, the entire Slot must be visible beyond the Gunwale. When the motor is deployed, there must be a minimum required distance of 1½" between the Gunwale and the bottom of the Steering Housing and Shaft.

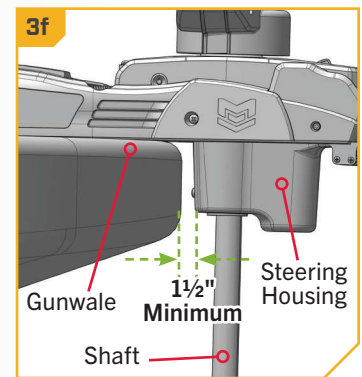
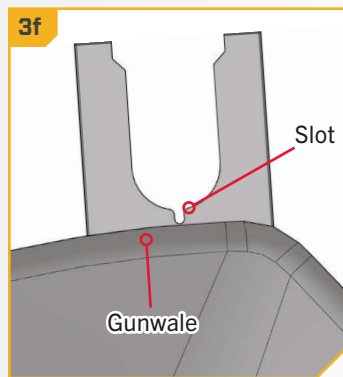
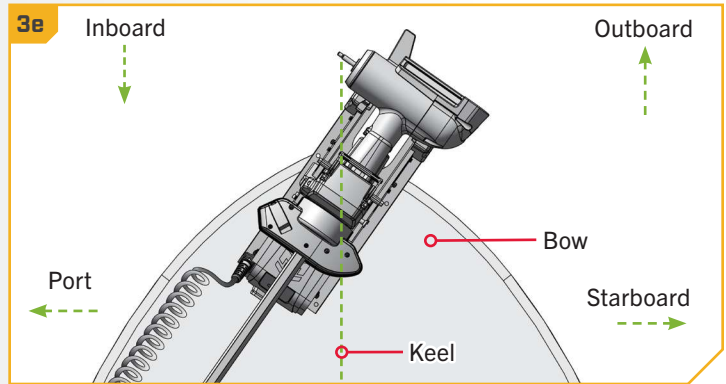

CAUTION

Illustrations are for reference only. Do not deploy the motor until it is fully mounted to the boat. Deploying the motor before it is mounted to the boat may cause injury.

- g. When mounting the Ulterra QUEST, all six mounting holes must be used. If the desired mounting location does not allow for all six mounting holes, a Boat Deck Reinforcement Kit (1854058) should be used or a new mounting location selected.

4

- h. With the motor at the intended mounting location, take an Awl or similar tool and mark all six mounting holes in the Base Extrusion.
- i. Slide the motor aside to drill the mounting holes. Drill through the boat deck using a Drill and a 3/8" Drill Bit on all six marked locations.
- j. Reposition the motor over the drilled holes to install mounting hardware.

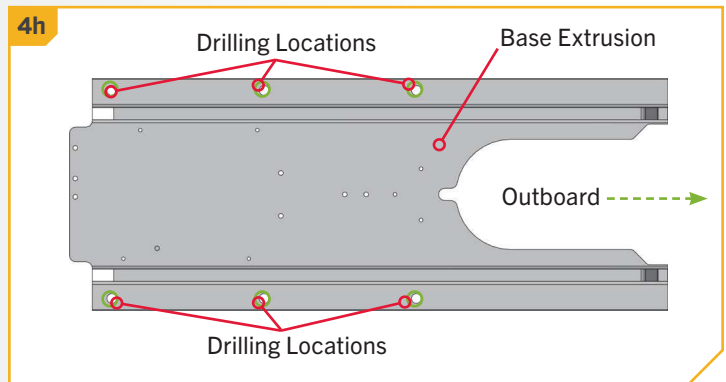

NOTICE: New mounting holes are required when upgrading from an Ulterra to an Ulterra QUEST. New mounting holes will accommodate the higher thrust motor and ensure the installation is secure.

NOTICE: The mounting surface for the Ulterra QUEST must be flat. Rubber Washers can be used to shim the Base Extrusion flat before hardware is tightened.

INSTALLING THE ULTERRA QUEST

5

ITEM(S) NEEDED



#1 x 3

#2 x 3



#3 x 3



#4 x 3



#5 x 1

NOTICE: To prevent seizing of the stainless steel hardware, do not use high-speed installation tools. Wetting the bolts or applying an anti-seize (Item #5) may help prevent seizing.

- k. Begin on the Starboard side of the motor.
- l. Take three Hex Head Bolts (Item #1) and apply anti-seize (Item #5) to each Bolt. Insert the Bolts through the Base Extrusion and into the drilled locations. If Rubber Washers (Item #3) are used, the Rubber Washers should sit between the Base Extrusion and boat deck.
- m. Place a Backup Bar (Item #4) and then a Nylock Nut (Item #2) on the end of each Bolt. Tighten with a 9/16" Box End or Open End Wrench. Make sure all hardware is secure.

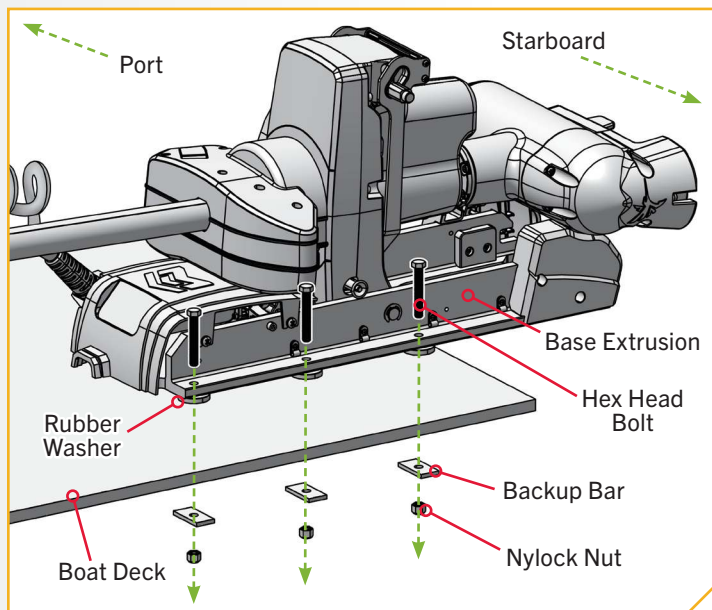

NOTICE: Use extra care to avoid pinching and damaging the sensor wires that run alongside the Base Extrusion when installing and tightening the mounting hardware.

INSTALLING THE ULTRERA QUEST

6

ITEM(S) NEEDED



#1 x 2

#2 x 2



#3 x 2



#4 x 2



#5 x 1

NOTICE: To prevent seizing of the stainless steel hardware, do not use high-speed installation tools. Wetting the bolts or applying an anti-seize (Item #5) may help prevent seizing.

- n. Move to the Port side of the motor.
- o. Take two Hex Head Bolts (Item #1) and apply anti-seize (Item #5) to both Bolts. Insert the Bolts down through the Base Extrusion and into the two mounting holes furthest outboard. If Rubber Washers (Item #3) are used, the Rubber Washers should sit between the Base Extrusion and boat deck.
- p. Place a Backup Bar (Item #4) and then a Nylock Nut (Item #2) on the end of each Bolt. Tighten with a 9/16" Box End or Open End Wrench. Make sure all hardware is secure.

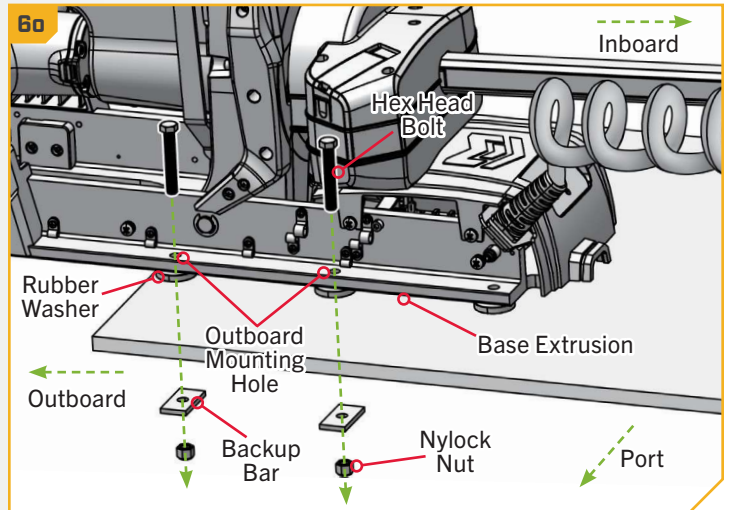

NOTICE: Use extra care to avoid pinching and damaging the sensor wires that run alongside the Base Extrusion when installing and tightening the mounting hardware.

INSTALLING THE ULTRERA QUEST

7

ITEM(S) NEEDED



#1 x 1

#2 x 1



#3 x 1



#4 x 1



#5 x 1

- q. To complete the installation, the last Bolt must be inserted into the Base Extrusion from the bottom up.
- r. Take one Hex Head Bolt (Item #1) and apply anti-seize (Item #5) to the Bolt. Place a Backup Bar (Item #4) onto the Bolt, then insert the Bolt up through the boat deck. The Bolt will pass through the boat deck, Rubber Washer (Item #3) if used, then the Base Extrusion.
- s. While holding the Bolt in place, take a Nylock Nut (Item #2) and place it on the end of the Bolt. Check that the end of the Bolt does not collide with the Extrusion Spacer. Secure the Nylock Nut against the Base Extrusion with a 9/16" Box End or Open End Wrench. Ensure the threads of the Bolt are visible past the end of the Nylock Nut.

NOTICE: The Backup Bar and Hex Head Bolt must be flush against the boat deck. Due to variances in boat deck material, a different bolt length or additional spacing washers may be required. Spacing washers should be placed between the Hex Head Bolt and Backup Bar. Any alternative hardware used to install the motor must be stainless steel.

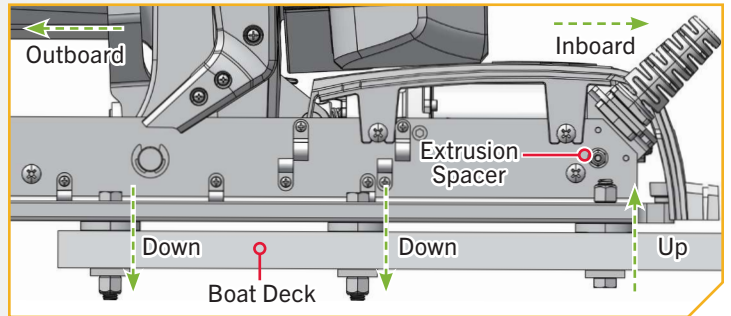
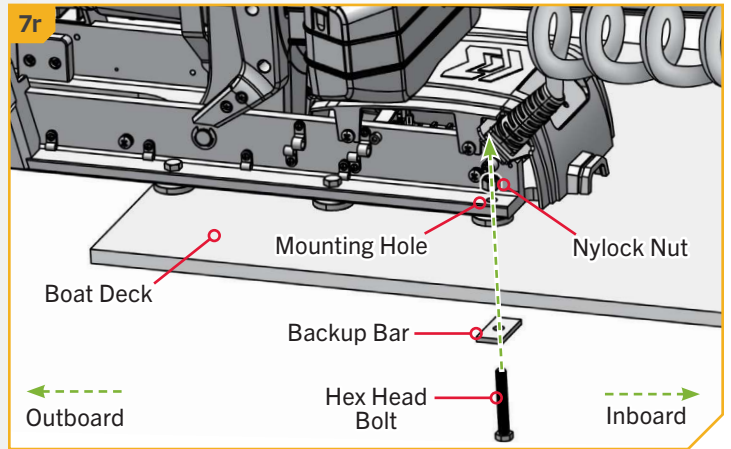

8

- t. Replace the Right Sideplate and Left Sideplate. Replace the four Sideplate Screws using a #3 Phillips Screwdriver. Two of these screws will be located on each side of the mount.

NOTICE: When reinstalling the Sideplates, use care to avoid pinching the sensor wires that run alongside the Base Extrusion.

NOTICE: Ensure that the area between the Mount and Steering Housing is clean and free of debris and that no installation hardware has fallen in. The Mount contains a Stow Pad that contacts the Steering Housing when stowed. The motor cannot stow securely if an obstruction is present on the Stow Pad.

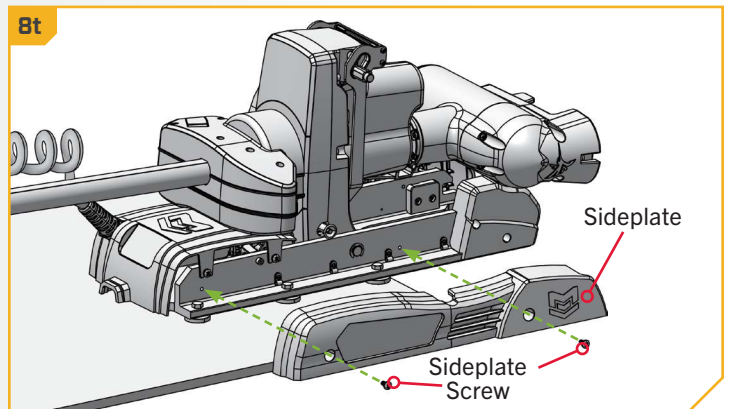

BATTERY & WIRING INSTALLATION

BOAT RIGGING & PRODUCT INSTALLATION

For safety and compliance reasons, we recommend that you follow American Boat and Yacht Council (ABYC) standards when rigging your boat. Altering boat wiring should be completed by a qualified marine technician. The following specifications are for general guidelines only:

CAUTION

These guidelines apply to general rigging to support your Minn Kota motor. Powering multiple motors or additional electrical devices from the same power circuit may impact the recommended conductor gauge and circuit breaker size. If you are using wire longer than that provided with your unit, follow the conductor gauge and circuit breaker sizing table below. If your wire extension length is more than 25 feet, we recommend that you contact a qualified marine technician.

CAUTION

An over-current protection device (circuit breaker or fuse) must be used. Coast Guard requirements dictate that each ungrounded current-carrying conductor must be protected by a manually reset, trip-free circuit breaker or fuse. The type (voltage and current rating) of the fuse or circuit breaker must be sized accordingly to the trolling motor used. The table below gives recommended guidelines for circuit breaker sizing.

CONDUCTOR GAUGE AND CIRCUIT BREAKER SIZING TABLE

This conductor and circuit breaker sizing table is only valid for the following assumptions:

1. No more than 2 conductors are bundled together inside of a sheath or conduit outside of engine spaces.
2. Each conductor has 105° C temp rated insulation.
3. No more than 3% voltage drop allowed at full motor power based on published product power requirements.

Motor Thrust / Model	Max Amp Draw	Circuit Breaker		Wire Extension Length				
		Amps	Minimum	5 feet	10 feet	15 feet	20 feet	25 feet
QUEST 24V	60	60 Amp	24 VDC	6 AWG	6 AWG	4 AWG	4 AWG	2 AWG
QUEST 36V	60	60 Amp	36 VDC	6 AWG	6 AWG	6 AWG	6 AWG	4 AWG

NOTICE: Wire Extension Length refers to the distance from the batteries to the trolling motor leads. Consult website for available thrust options.

Reference

United States Code of Federal Regulations: 33 CFR 183 – Boats and Associated Equipment ABYC E-11: AC and DC Electrical Systems on Boats

SELECTING THE CORRECT BATTERIES

SELECTING THE CORRECT BATTERIES

QUEST series motors will operate with any deep cycle marine 12, 24 or 36-volt battery/batteries and have been optimized for use with LiFePO₄ lithium-ion battery cells. Lithium-ion batteries maintain higher voltages for more extended periods than lead-acid batteries and will provide the best performance in powering the trolling motor.

QUEST series trolling motors may also be powered with lead-acid (flooded, AGM, or GEL) deep-cycle marine 12-volt battery/batteries. For best results Minn Kota recommends using a deep-cycle marine battery with rating outlined in the "Deep Cycle Amp-Hour Rating" table. Maintain lead-acid batteries at full charge. Proper care will ensure battery power when needed and significantly improve battery life. Failure to recharge lead-acid batteries (within 12-24 hours) is the leading cause of premature battery failure. Use a multi-stage charger to avoid overcharging. When using Lithium Ion batteries, manufacturers may recommend storing in a semi-charged state and charging fully prior to use.

Deep Cycle Amp-Hour Rating			
Run Time	Voltage	Group Size	Amp-Hour
GOOD	12	24	70-85
BETTER	12	27	85-110
BEST	12	31	95-125

If using a crank battery to start a gasoline outboard, Minn Kota recommends using a separate battery/batteries for your Minn Kota trolling motor. Always check with the battery manufacturer for specific maintenance, care and storage instructions. Minn Kota also offers a wide selection of chargers to fit your charging needs. For more information on battery selection, rigging, and chargers, please visit minnkota.johnsonoutdoors.com.

WARNING

Never connect the (+) and the (-) terminals of the same battery together. Take care that no metal object can fall onto the battery and short the terminals. This would immediately lead to a short and extreme fire danger.

CAUTION

Refer to "Conductor Gauge and Circuit Breaker Sizing Table" in the previous section to find the appropriate circuit breaker or fuse for your motor. For motors requiring a 60-amp breaker, the Minn Kota MKR-27 60-amp circuit breaker (1865115) is recommended.

CAUTION

Please read the following information before connecting your motor to your batteries in order to avoid damaging your motor and/or voiding your warranty.

ADDITIONAL CONSIDERATIONS

› Using DC or Alternator Chargers

Your Minn Kota trolling motor may be designed with an internal bonding wire to reduce sonar interference. Most alternator charging systems do not account for this bonding wire, and connect the negative posts of the trolling motor batteries to the negative posts of the crank/starting battery. These external connections can damage connected electronics and the electrical system of your trolling motor, voiding your warranty. Review your charger's manual carefully or consult the manufacturer prior to use to ensure your charger is compatible.

Minn Kota recommends using Minn Kota brand chargers to recharge the batteries connected to your Minn Kota trolling motor, as they have been engineered to work with motors that include a bonding wire. Learn more about Minn Kota chargers online at minnkota.johnsonoutdoors.com.

CONNECTING THE BATTERIES IN SERIES

› Additional Accessories Connected to Trolling Motor Batteries

Significant damage to your Minn Kota motor, your boat electronics, and your boat can occur if incorrect connections are made between your trolling motor batteries and other battery systems. Minn Kota recommends using an exclusive battery system for your trolling motor. Where possible, accessories should be connected to a separate battery system. Radios and sonar units should not be connected to any trolling motor battery systems as interference from the trolling motor is unavoidable. If connecting any additional accessories to any trolling motor battery system, or making connections between the trolling motor batteries and other battery systems on the boat, be sure to carefully observe the information below.

The negative (-) connection must be connected to the negative terminal of the same battery that the trolling motor negative lead connects to. In the diagrams below this battery is labeled “Low Side” Battery. Connecting to any other trolling motor battery will input positive voltage into the “ground” of that accessory, which can cause excess corrosion. Any damage caused by incorrect connections between battery systems will not be covered under warranty.

› Automatic Jump Start Systems and Selector Switches

Automatic jump start systems and selector switches tie the negatives of the connected batteries together. Connecting these systems to the “High Side” Battery or “Middle” Battery in the diagrams below and will cause significant damage to your trolling motor and electronics. The only trolling motor battery that is safe to connect to one of these systems is the “Low Side” Battery.

CONNECTING THE BATTERIES IN SERIES (IF REQUIRED FOR YOUR MOTOR)

› 24-Volt Systems

Two 12-volt batteries are required. The batteries must be wired in series, only as directed in the wiring diagram, to provide 24 volts.

1. Make sure that the motor is switched off (speed selector on “0”).
2. Connect a connector cable to the positive (+) terminal of battery 1 and to the negative (-) terminal of battery 2.
3. Connect positive (+) red motor lead to positive (+) terminal on battery 2.
4. Connect negative (-) black motor lead to negative (-) terminal of battery 1.

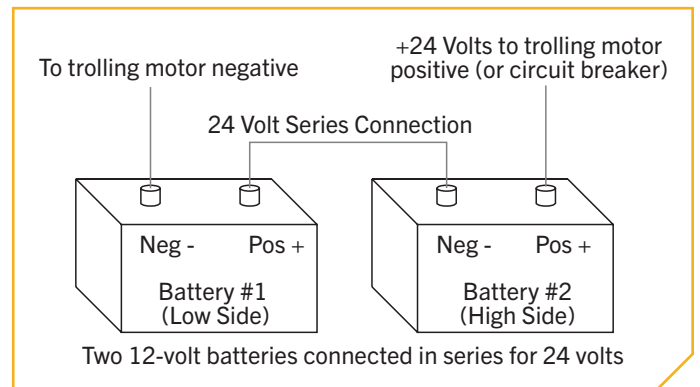

WARNING

For safety reasons do not switch the motor on until the propeller is in the water. If installing a leadwire plug, observe proper polarity and follow instructions in your boat owner’s manual.

WARNING

- For safety reasons, disconnect the motor from the battery or batteries when the motor is not in use or while the battery/batteries are being charged.
- Improper wiring of 24/36 volt systems could cause battery explosion.
- Keep leadwire wing nut connections tight and solid to battery terminals.
- Locate battery in a ventilated compartment.

CONNECTING THE BATTERIES IN SERIES

36-Volt Systems

Three 12-volt batteries are required. The batteries must be wired in series, only as directed in the wiring diagram, to provide 36 volts.

1. Make sure that the motor is switched off (speed selector on "0").
2. Connect a connector cable to the positive (+) terminal of battery 1 and to the negative (-) terminal of battery 2 and another connector cable from the positive (+) terminal of battery 2 to the negative (-) terminal of battery 3.
3. Connect positive (+) red motor lead to positive (+) terminal on battery 3.
4. Connect negative (-) black motor lead to negative (-) terminal of battery 1.

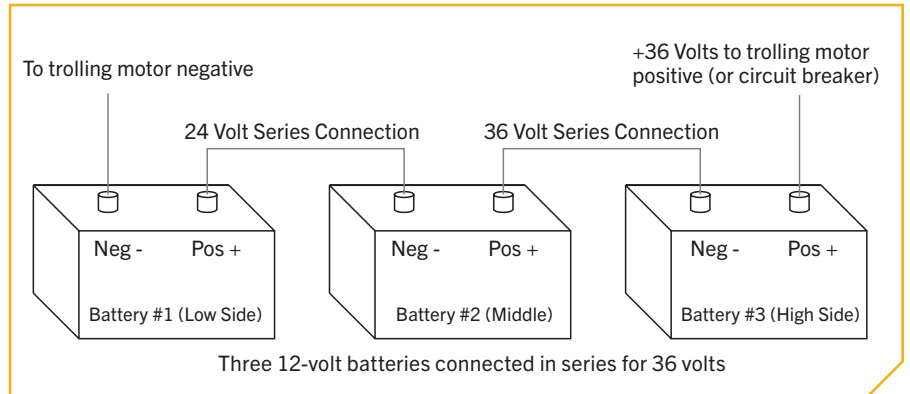

WARNING

For safety reasons, do not switch the motor on until the propeller is in the water. If installing a leadwire plug, observe proper polarity and follow instructions in your boat owner's manual.

WARNING

- For safety reasons, disconnect the motor from the battery or batteries when the motor is not in use or while the battery/batteries are being charged.
- Improper wiring of 24/36 volt systems could cause battery explosion.
- Keep leadwire wing nut connections tight and solid to battery terminals.
- Locate battery in a ventilated compartment.

COMPLETING THE INSTALLATION

COMPLETING THE ULTERRA QUEST INSTALLATION



The Ulterra QUEST is an advanced trolling motor. To maximize its performance, mechanical and electrical systems should be set and calibrated to fit every user's installation. This portion of the installation will cover how to verify power, install the Bow-mount Stabilizer, and more. The installation will conclude with connecting Accessory Cables and setting motor preferences for ease of use. Minn Kota recommends connecting the trolling motor to the One-Boat Network app to assist in these steps. Find more information in the One-Boat Network App document included with the trolling motor or the One-Boat Network Owner's Manual found online at minnkota.johnsonoutdoors.com.

COMPLETING THE INSTALLATION >

> Verifying Power

Each time the trolling motor is powered "on," the control board will auto-detect the power supplied from the battery system and adjust the thrust output based on a 24V or 36V battery system. To verify power to the trolling motor, connect the Ulterra QUEST to power. At specific points in the installation, power will be disconnected or turned "off" to ensure a safe environment for installation.

1

- a. Locate the Indicator Panel at the front of the Mount. Power on the trolling motor by pressing the Power  button on the Indicator Panel. When the trolling motor is on, the System Status  LED will be blue.
- b. To turn the motor "off," press and release the Power button. When the Motor is powered off, the System Status  LED will not be illuminated.

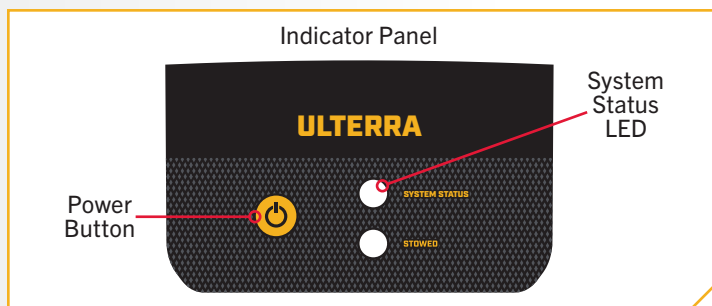

NOTICE: In instances where the trolling motor is updating, the System Status LED will flash blue while the update is performed. Once the update is complete, the system will self-reboot and perform the normal start-up sequence. If a standard power-up sequence is not experienced, please see the Troubleshooting section of the Ulterra QUEST Owner's Manual to identify any errors. To learn more about software updates, please see the Owner's Manual for the One-Boat Network or Advanced GPS Navigation Wireless Remote.

> Installing the Bow-Mount Stabilizer

Ulterra QUEST motors with a 72" shaft length come with an MKA-60 Bow-Mount Stabilizer Kit (Item #9 and Assembly #E). This accessory stabilizes the shaft and control head when the motor is stowed for transport. Motors with shaft lengths under 72" may purchase the MKA-60 separately as an optional accessory (1862060). For instructions on installing the MKA-60 to the Ulterra QUEST, refer to the document provided with the Bow-Mount Stabilizer Kit.

POWERING ON THE WIRELESS REMOTE

› Powering on the Wireless Remote

1







ITEM(S) NEEDED



#8 x 1



#7 x 1

- Power on the trolling motor.
- To turn on the Wireless Remote (Item #8), press and hold the Power  button on the side of the Remote.
- A message will appear on the display screen. Read the disclaimer, then press the Steer Right  button to select "I Agree."
- The content on the display screen will populate. Remote functions to manually control the motor are now active, including Speed Up , Speed Down , Steer Left , Steer Right , and Prop On/Off.
- When the Advanced GPS Navigation system has obtained a minimum GPS signal strength of one bar, all remaining functions will become available.

NOTICE: Attaching the Lanyard (Item #7) to the Wireless Remote is optional.

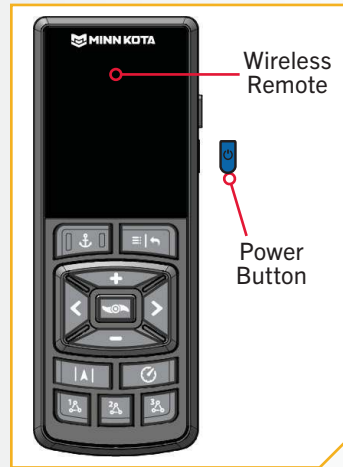

Warning!
You are responsible for the safe and prudent operation of your boat. This product does not relieve you from the responsibility for safe operation of your boat.

I Agree 

NOTICE: The Wireless Remote comes from the factory paired to the Ulterra QUEST.

NOTICE: A Remote Cradle accessory (1866675) can be purchased for mounting the Wireless Remote or attaching the Remote to a belt clip.

› Installing the Foot Pedal

1

ITEM(S) NEEDED

 #14 x 4

 #C x 1

- a. Take the Foot Pedal (Item #C) and turn it over. Put a Foot Pedal Pad (Item #14) in each of the pad locations.

NOTICE: Adding the Foot Pedal pads is optional. The pads are recommended when using the Foot Pedal on non-carpeted surfaces.

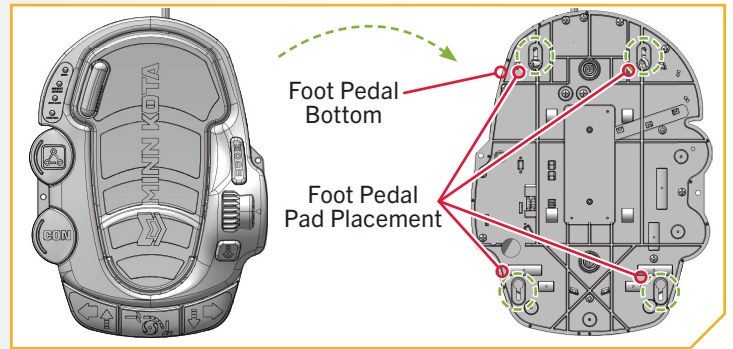

2

- b. Locate the Foot Pedal Power Cord that exits the Mount of the trolling motor, next to the Power Cables. Unscrew the Cap on the Plug at the end of the Foot Pedal Power Cord.
- c. Locate the 4-Pin Plug from the Foot Pedal and unscrew the Cap.
- d. Align the 4-Pin Plug from the Foot Pedal with the Plug from the trolling motor. Firmly push the Plugs together. Secure the connection by rotating the collar on the Foot Pedal Power Cord in a clockwise direction.

NOTICE: The connectors are keyed to prevent reversed installation.

NOTICE: When the Foot Pedal Power Cord is not in use, ensure that the Cap is on and firmly secured.

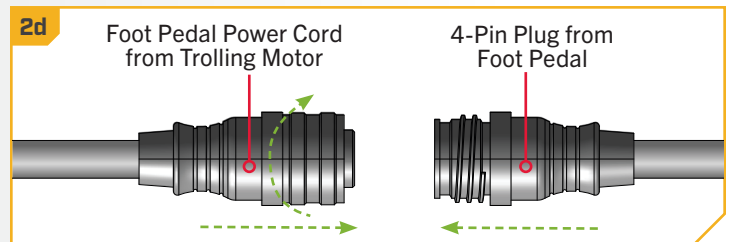
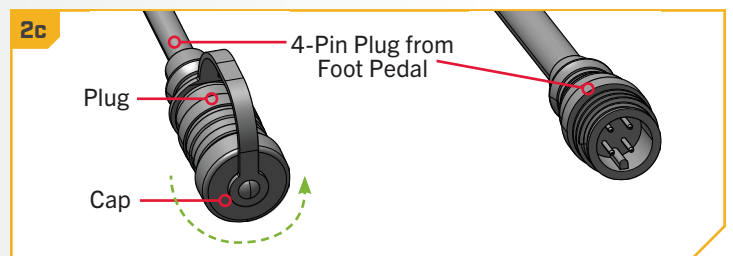
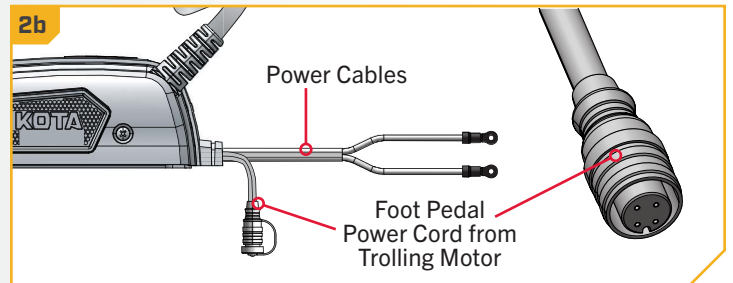

IDENTIFYING TROLLING MOTOR FEATURES AND THEIR ASSOCIATED CABLES

IDENTIFYING TROLLING MOTOR FEATURES AND THEIR ASSOCIATED CABLES

Feature & Cable Identification

The Ulterra QUEST is pre-installed with Advanced GPS Navigation - including the ability to connect via Ethernet to a Humminbird unit. The motor is also pre-installed with sonar, either Dual Spectrum CHIRP or Built-in MEGA Side Imaging. These features may be installed on their own or in combination with another feature. All of these features require Accessory Cables to be connected to an output device. The connectors are present on the trolling motor and have cables that exit below the Control Head. To better identify Accessory Cables present, refer to the diagrams that detail what the Dual Spectrum CHIRP, Built-in MEGA Side Imaging and Advanced GPS Navigation connectors look like.

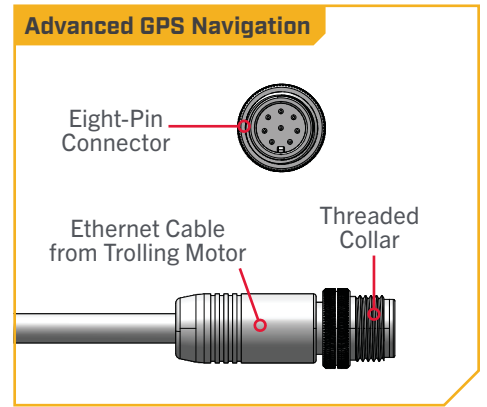
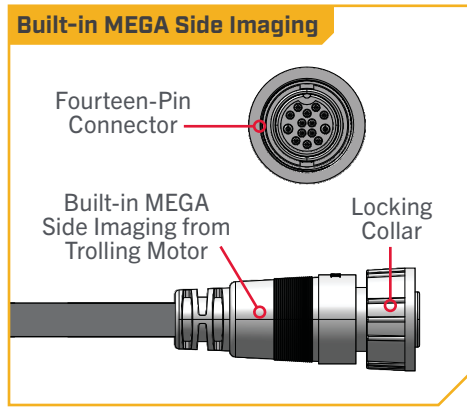
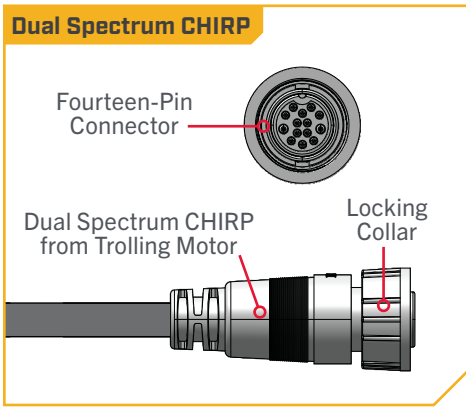

Identifying Connectors

Two connectors are present below the Control Head. The trolling motor will be equipped with:

Advanced GPS Navigation & Dual Spectrum CHIRP or Built-in MEGA Side Imaging - Advanced GPS Navigation is pre-installed on your trolling motor. One Eight-Pin Advanced GPS Ethernet Connector will exit the base of the Control Head and rest just below the Control Head next to the Coil Cord. If the Advanced GPS Navigation on the trolling motor will be used with a fish finder, an Ethernet Cable may be attached to the Advanced GPS Ethernet Connector below the Control Head. See the "Advanced GPS Navigation" section of this document for details on how to install the Advanced GPS Ethernet Connector to a Humminbird.

Dual Spectrum CHIRP or Built-in MEGA Side Imaging is also pre-installed on your trolling motor. One Sonar Accessory Cable will exit the base of the Control Head and run down the center of the Coil Cord. The end of this Cable has a Fourteen-Pin Connector. Motors with Dual Spectrum CHIRP or Built-in MEGA Side Imaging will also have a transducer in the Lower Unit. The appearance of the transducer will vary depending on sonar type.

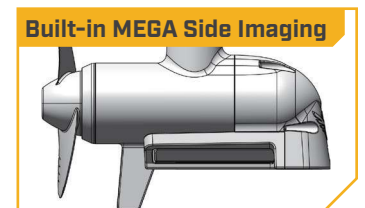
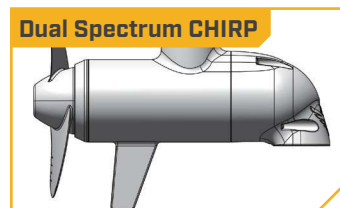
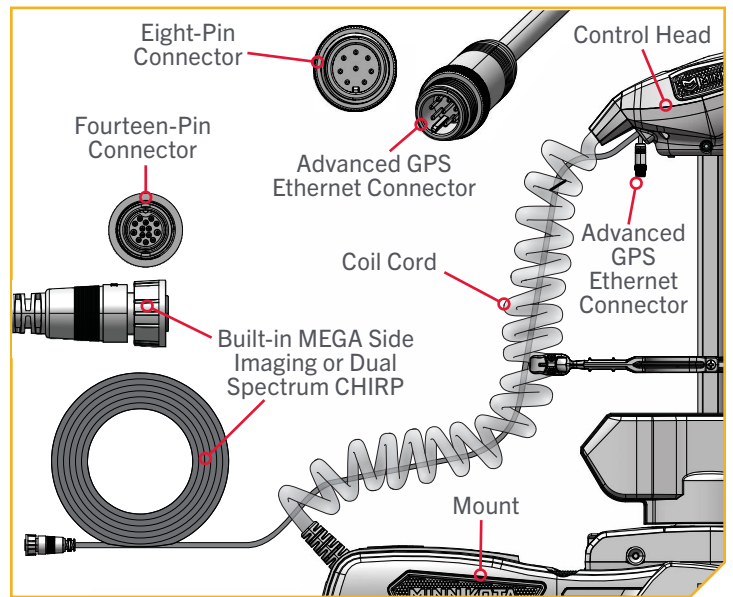

› Feature & Cable Management

DUAL SPECTRUM CHIRP ›

Your trolling motor may be pre-installed with a transducer system featuring Humminbird's Dual Spectrum CHIRP. CHIRP stands for "Compressed High Intensity Radar Pulse." Dual Spectrum CHIRP is a 2D sonar transducer with a temperature sensor that is integrated into the lower unit of the trolling motor. Humminbird also utilizes a proprietary, best-in-class transducer designed and built to maximize fish detail, as well as coverage area. Dual Spectrum CHIRP scans the water for fish similar to the way the seek function on your truck's radio scans the airwaves for FM stations. By covering a wide range of frequencies, CHIRP produces more accurate, more detailed returns of fish, structure, and the bottom.

Humminbird's Dual Spectrum CHIRP gives you full spectrum capability, plus the power to select your own start and end frequencies by operating in two different modes. Wide Mode for maximum coverage and Narrow Mode for maximum detail. Wide mode allows you to search deep and wide. Is it used for watching your lure while vertical jigging, or gaining a more expansive view in shallow water. Narrow Mode is used to hone in on the small stuff that makes a big difference. Narrow Mode provides a precise perspective of the water below, helping you target individual fish, or identify fish hidden in structure and/or tight to the bottom.

Dual Spectrum CHIRP features:

SUPERIOR TARGET SEPARATION - Separating fish from their habitat is the name of the game. And now, you'll be able to tell the difference more easily between bait and game fish, and nearby structure and vegetation.

CLEARLY DEFINED FISH ARCHES - We've got bad news for your arch nemesis. Large game fish will show up on your screen as long, well-defined arches, for quick identification and accurate lure presentation.

STRONG RETURNS WITHOUT NOISE - Stop seeing things that aren't there. A high signal-to-noise ratio translates to better defined targets, less clutter and greater certainty that what you're looking at on-screen is legit.

Dual Spectrum CHIRP Lower Unit

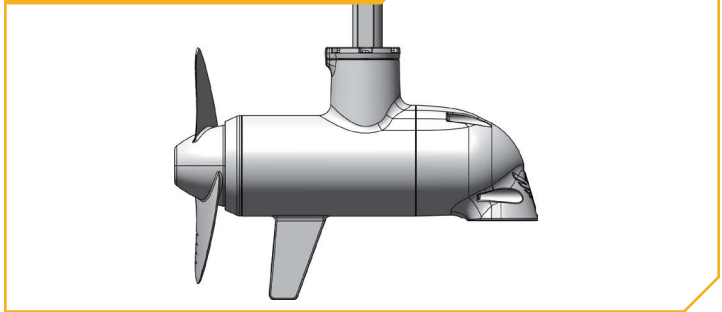

Wide Mode

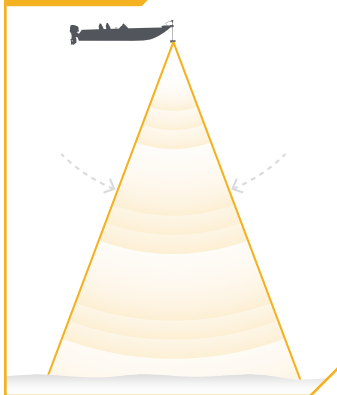

Narrow Mode

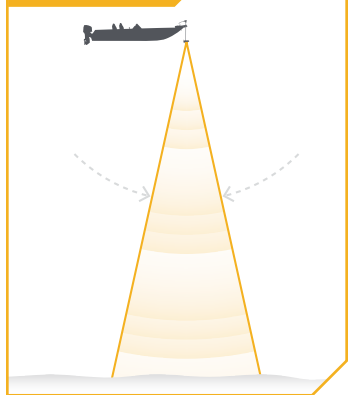

Target Separation

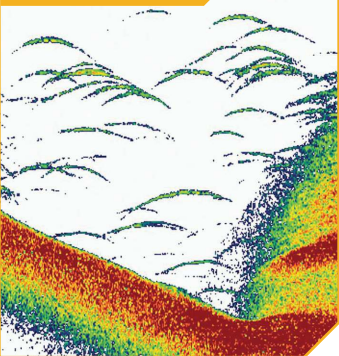

Defined Fish Arches

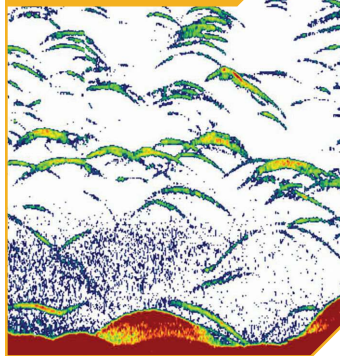

Strong Returns

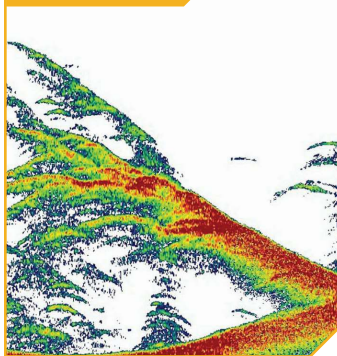

DUAL SPECTRUM CHIRP

The integrated design of the Dual Spectrum CHIRP transducer protects it in the lower unit of the trolling motor from underwater hazards and prevents tangles and damage to the transducer cables. In certain situations, air bubbles may adhere to the surface of the Dual Spectrum CHIRP transducer and affect the performance. If this happens, simply wipe the surface of the transducer with your finger.

› Considerations for Connecting and Routing Dual Spectrum CHIRP

If Dual Spectrum CHIRP is pre-installed on your trolling motor, one Dual Spectrum CHIRP accessory cable will exit the base of the Control Head and run down the center of the Coil Cord. Dual Spectrum CHIRP requires cables to be connected to an output device such as a Humminbird® fish finder. The Dual Spectrum CHIRP cable that exits the Control Head is "Apex and Solix Ready." Connecting the trolling motor equipped with a Dual Spectrum CHIRP transducer to a compatible fish finder gives you a 2D sonar view of what is happening directly below your trolling motor. To determine if your fish finder is compatible with Dual Spectrum CHIRP, please visit minnkota.johnsonoutdoors.com to check compatibility. The Dual Spectrum CHIRP cable from the trolling motor may be plugged directly into a Solix or Apex, directly into an Extension Cable or directly into a Humminbird® Helix Adapter Cable.

EXTENSION CABLES - The Dual Spectrum CHIRP cable from the trolling motor may not be long enough to reach your fish finder. If the cable length does not reach the desired fish finder installation location, extension cables are available. A 10-foot extension cable ([EC M3 14W10 - 10' transducer extension cable - 720106-1](#)) and a 30-foot extension cable ([EC M3 14W30 - 30' transducer extension cable - 720106-2](#)) are available from humminbird.johnsonoutdoors.com. Both the 10-foot and 30-foot extension cables also come "Apex and Solix Ready." The Extension Cables may plug directly into a Solix or Apex or directly into a Helix Adapter Cable.

HUMMINBIRD HELIX ADAPTER CABLES - If connecting to a Humminbird® Helix fish finder, an adapter cable accessory is included that will allow the connection of any compatible Humminbird® Helix fish finder. The Helix adapter cables will plug directly into the Helix fish finder.

OTHER FISH FINDER ADAPTER CABLES - If connecting to other fish finders on the market, check for compatibility or any required adapter cables online at minnkota.johnsonoutdoors.com.

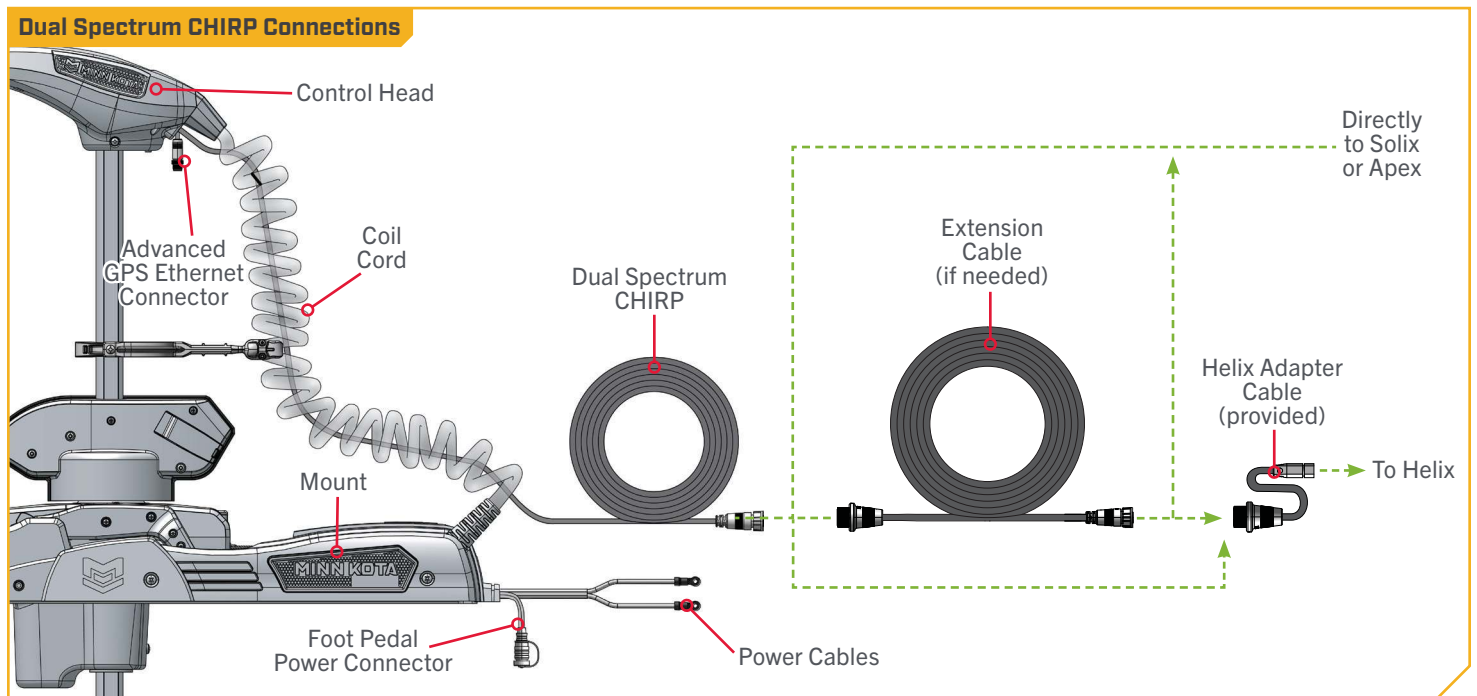

All Dual Spectrum CHIRP Ulterra QUEST motors are equipped with an internal bonding wire. Incorrect rigging will cause sonar interference and can damage your trolling motor, electronics, and other boat accessories. To minimize trolling motor interference, ensure that the fish finder and trolling motor are powered by separate batteries. Refer to the "Battery & Wiring Installation" section of this manual for correct rigging instructions.

The Dual Spectrum CHIRP cables are shielded to minimize interference. To protect this shielding, the cables should not be pulled tight against sharp angles or hard objects. If using cable ties, do not over-tighten. Any excess cable should be bundled in a loose loop of no less than 4" in diameter. The connection cable should be routed to the fish finder following Minn Kota recommendations on routing the cables to optimize mobility and maximize functionality. Follow the instructions below for completing all connections and then follow the instructions for "Securing Accessory Cables" to complete the output cable installation.

CAUTION

Failure to follow the recommended wire routing for installed features, if equipped, may cause damage to the product and void your product warranty. Route cables away from pinch points or other areas that may cause them to bend in sharp angles. Routing the cables in any way other than directed may cause damage to the cables by being pinched or severed. Do not over-tighten the cable ties as it may damage the wires.

1

NOTICE: Your fish finder should be turned off until this procedure is complete.

- a. Place the motor in the deployed position.

NOTICE: For instructions on deploying the motor, see the "Stowing and Deploying the Ulterra QUEST" section of this manual.

- b. Locate the Fourteen-Pin Connector at the end of the Dual Spectrum CHIRP accessory cable. The cable will exit the base of the Control Head and run down the center of the Coil Cord.
- c. Determine if the Plug on the end of the Dual Spectrum CHIRP accessory cable will be attached directly to:
 - 1) a Humminbird® Solix or Apex fish finder,
 - 2) a Dual Spectrum CHIRP Extension Cable,
 - 3) a Helix Adapter Cable or a compatible fish finder adapter cable.

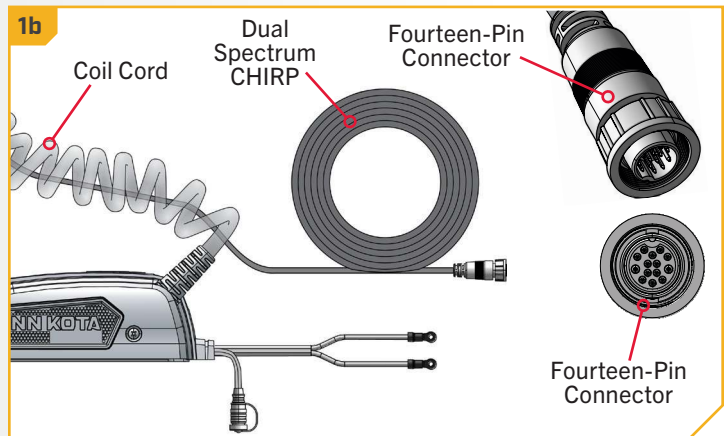

DUAL SPECTRUM CHIRP

2

- d. If installing directly to a Solix or Apex, the connection will be flat on the back of the fish finder display.
- e. Align the pins on the Accessory Cable with the receptacle on the fish finder. Notice the keyed connectors. Tighten the Collar from the accessory cable to secure the connection. Once directly installed to the Solix or Apex, the connection is complete.

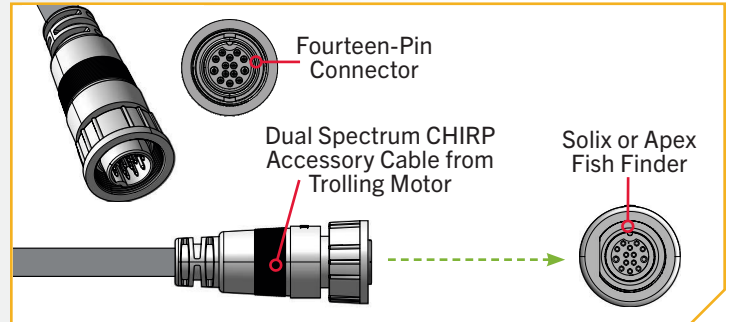

3

- f. If installing directly to a Dual Spectrum CHIRP Extension Cable, align the pins on the accessory cable with the receptacle on the extension cable. Notice the keyed connectors. Tighten the Collar from the accessory cable to secure the connection.
- g. If the Dual Spectrum CHIRP extension cable will be attached directly to a Humminbird® Solix or Apex, the connection will look exactly like the installation directly into a Humminbird Solix or Apex fish finder.

NOTICE: A 10-foot extension cable (EC M3 14W10 - 10' transducer extension cable - 720106-1) and a 30-foot extension cable (EC M3 14W30 - 30' transducer extension cable - 720106-2) are available from humminbird.johnsonoutdoors.com.

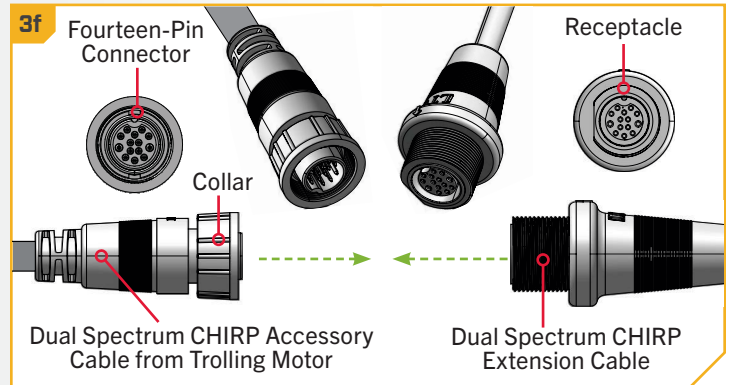

4

ITEM(S) NEEDED



- h. If installing directly to a Helix Adapter Cable, align the pins on the accessory cable or extension cable with the receptacle on the Helix Adapter Cable (Item #18). Notice the keyed connectors. Tighten the Collar from the accessory cable or extension cable to secure the connection.
- i. If the Helix Adapter Cable will be attached directly to a Humminbird® Helix, plug it in the Helix Adapter Cable Keyed Connection on the back of the fish finder.

NOTICE: If connecting to other fish finders on the market, check for compatibility or any required adapter cables online at minnkota.johnsonoutdoors.com.

- j. If the trolling motor has more than one external connector for an output device, complete the connection for that specific output and then follow the instructions for "Securing Accessory Cables" to complete the output cable installation.

NOTICE: If unsure of what features the trolling motor may be installed with that require connection to an output device, review the "Identifying Trolling Motor Features and Their Associated Cables" section in this document.

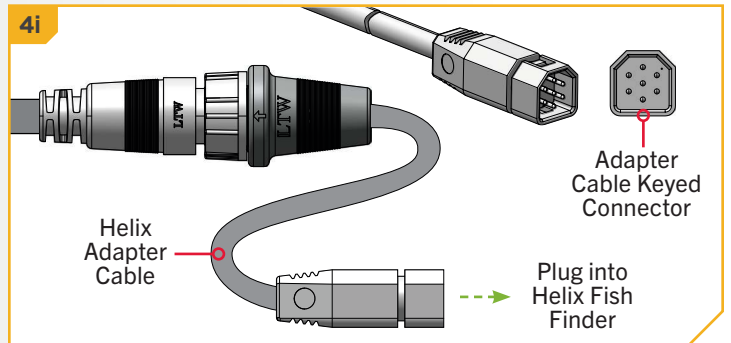
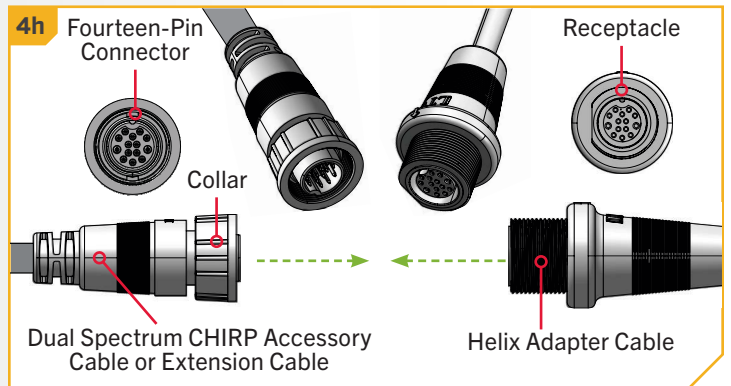

BUILT-IN MEGA SIDE IMAGING



BUILT-IN MEGA SIDE IMAGING >

MEGA Imaging technology took fish finding into the megahertz frequency for the very first time. Now Built-in MEGA Side Imaging+ delivers up to 3X the output of standard Side Imaging®. Humminbird improved this technology even further by extending the depth range and expanding the side coverage areas, all while improving the crystal clear imagery. Built-in MEGA Side Imaging+ comes available in the Minn Kota flagship families of trolling motors, including Ultrex and Ulterra, with 200 feet of coverage on either side of your boat. With Humminbird MEGA imaging sonar built right into the trolling motor, you now have a crystal clear view of what's directly to the left and right of your boat, without having to manage all of the cables that come with external transducers. The Built-in MEGA SI transducer is only available on new models equipped from the factory and cannot be added to an existing trolling motor.

> Considerations for Connecting and Routing Built-in MEGA Side Imaging

If Built-in MEGA Side Imaging is pre-installed on your trolling motor, one Built-in MEGA Side Imaging accessory cable will exit the base of the Control Head and run down the center of the Coil Cord. Built-in MEGA Side Imaging requires cables to be connected to an output device such as a Humminbird® fish finder. The Built-in MEGA Side Imaging cable that exits the Control Head is "Apex and Solix Ready." Connecting the trolling motor equipped with a Built-in MEGA Side Imaging transducer to a compatible fish finder gives you a 2D sonar view of what is happening directly below your trolling motor. To determine if your fish finder is compatible with Built-in MEGA Side Imaging, please visit minnkota.johnsonoutdoors.com to check compatibility. The Built-in MEGA Side Imaging cable from the trolling motor may be plugged directly into a Solix or Apex, directly into an Extension Cable or directly into a Humminbird® Helix Adapter Cable.

EXTENSION CABLES - The Built-in MEGA Side Imaging cable from the trolling motor may not be long enough to reach your fish finder. If the cable length does not reach the desired fish finder installation location, extension cables are available. A 10-foot extension cable (**EC M3 14W10 - 10' transducer extension cable - 720106-1**) and a 30-foot extension cable (**EC M3 14W30 - 30' transducer extension cable - 720106-2**) are available from humminbird.johnsonoutdoors.com. Both the 10-foot and 30-foot extension cables also come "Apex and Solix Ready." The Extension Cables may plug directly into a Solix or Apex or directly into a Helix Adapter Cable.

HUMMINBIRD HELIX ADAPTER CABLES - If connecting to a Humminbird® Helix fish finder, an adapter cable accessory is included that will allow the connection of any compatible Humminbird® Helix fish finder. The Helix adapter cable will plug directly into the Helix fish finder.

OTHER FISH FINDER ADAPTER CABLES - If connecting to other fish finders on the market, check for compatibility or any required adapter cables online at minnkota.johnsonoutdoors.com.

CAUTION

Failure to follow the recommended wire routing for installed features, if equipped, may cause damage to the product and void your product warranty. Route cables away from pinch points or other areas that may cause them to bend in sharp angles. Routing the cables in any way other than directed may cause damage to the cables by being pinched or severed. Do not over-tighten the cable ties as it may damage the wires.

NOTICE: You can only view Side Imaging with a MEGA DI or MEGA SI HELIX G2N, G3N or G4N Series model and a required adapter, or with any SOLIX or APEX Series model. The built-in transducer cannot supply MEGA Imaging to Humminbird models that do not already have the capability. If you have a G2/G2N, G3/G3N, G4/G4N HELIX that is not a MEGA SI or MEGA DI model, you will still get 2D Dual Spectrum CHIRP Sonar from the transducer. SOLIX G1 and HELIX G2 and G2N units need to be running the latest software update to view sonar from motors with Built-in MEGA Imaging. You can get the latest version of software for your fish finder on humminbird.johnsonoutdoors.com. Built-in MEGA Imaging is not supported by HELIX G1 models or other brands of fish finders.

BUILT-IN MEGA SIDE IMAGING

Built-in MEGA Side Imaging Connections

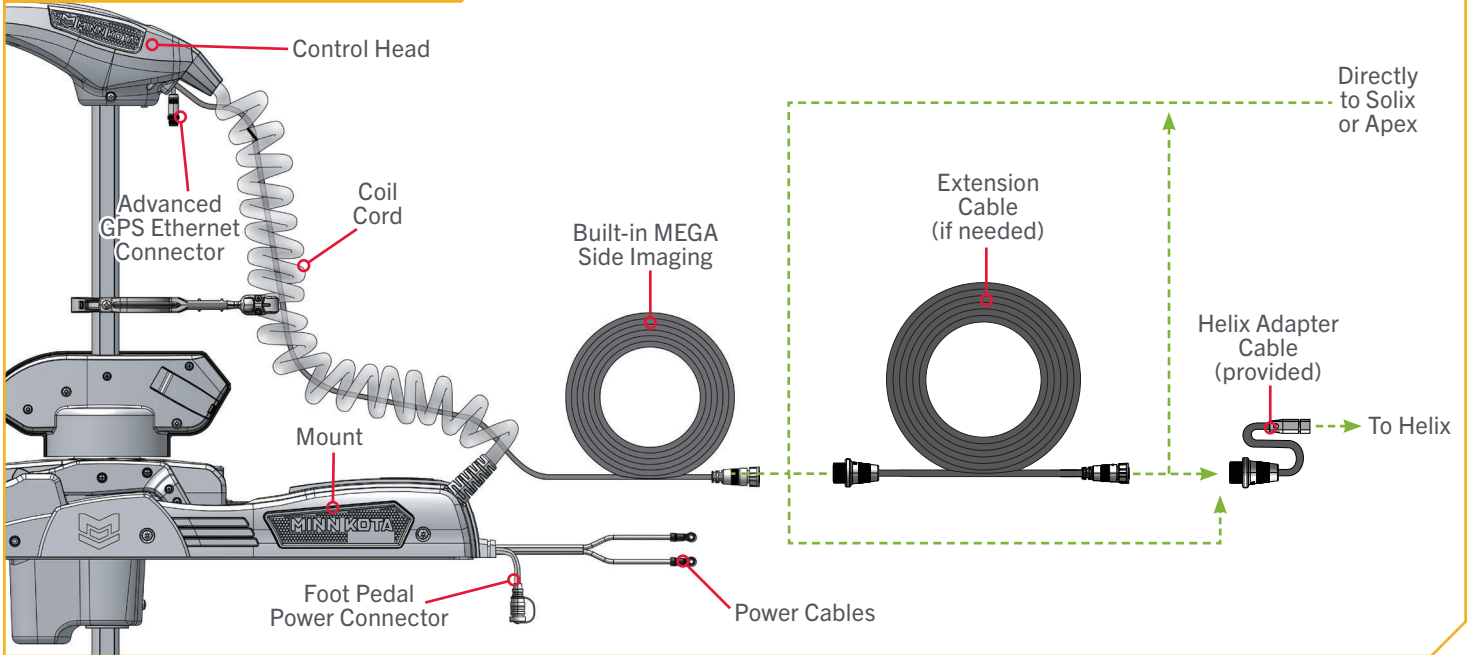

1

NOTICE: Your fish finder should be turned off until this procedure is complete.

- a. Place the motor in the deployed position.

NOTICE: For instructions on deploying the motor, see the “Stowing and Deploying the Ulterra QUEST” section of this manual.

- b. Locate the Fourteen-Pin Connector at the end of the Built-in MEGA Side Imaging accessory cable. The cable will exit the base of the Control Head and run down the center of the Coil Cord.
- c. Determine if the Plug on the end of the Built-in MEGA Side Imaging accessory cable will be attached directly to:
 - 1) a Humminbird® Solix or Apex fish finder,
 - 2) a Built-in MEGA Side Imaging Extension Cable,
 - 3) a Helix Adapter Cable or a compatible fish finder adapter cable.

1b

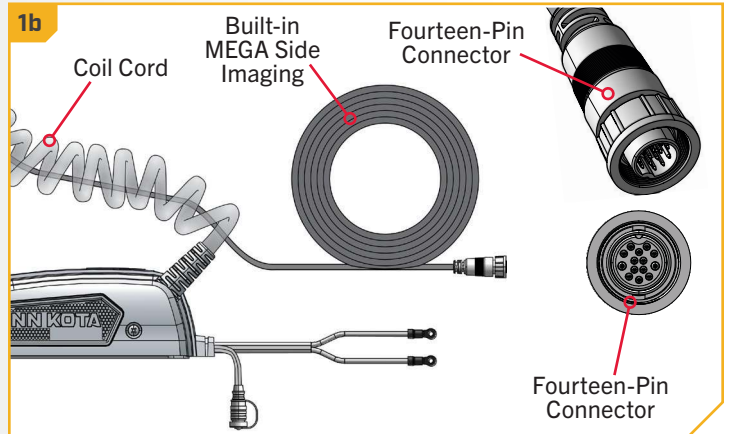

BUILT-IN MEGA SIDE IMAGING

2

- d. If installing directly to a Solix or Apex, the connection will be flat on the back of the fish finder display.
- e. Align the pins on the Accessory Cable with the receptacle on the fish finder. Notice the keyed connections. Tighten the Collar from the accessory cable to secure the connection. Once directly installed to the Solix or Apex, the connection is complete.

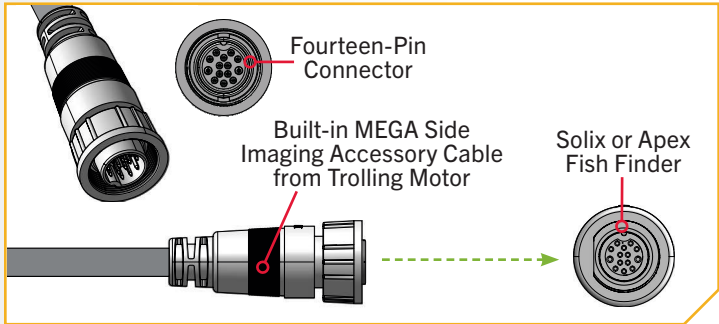

3

- f. If installing directly to a Built-in MEGA Side Imaging Extension Cable, align the pins on the accessory cable with the receptacle on the extension cable. Notice the keyed connectors. Tighten the Collar from the accessory cable to secure the connection.
- g. If the Built-in MEGA Side Imaging Extension Cable will be attached directly to a Humminbird® Solix or Apex, the connection will look exactly like the installation directly into a Humminbird Solix or Apex fish finder.

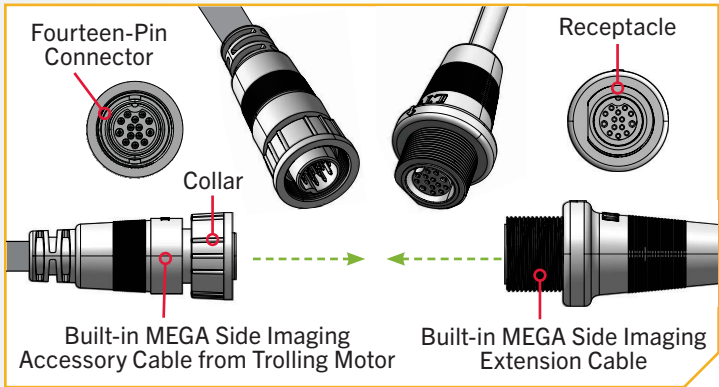

NOTICE: A 10-foot extension cable (EC M3 14W10 - 10' transducer extension cable - 720106-1) and a 30-foot extension cable (EC M3 14W30 - 30' transducer extension cable - 720106-2) are available from humminbird.johnsonoutdoors.com.

4

ITEM(S) NEEDED

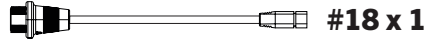

- h. If installing directly to a Helix Adapter Cable, align the pins on the accessory cable or extension cable with the receptacle on the Helix Adapter Cable (Item #18). Notice the keyed connectors. Tighten the Collar from the accessory cable or extension cable to secure the connection.
- i. If the Helix Adapter Cable will be attached directly to a Humminbird® Helix, plug it in the Helix Adapter Cable Keyed Connection on the back of the fish finder.

NOTICE: If connecting to other fish finders on the market, check for compatibility or any required adapter cables online at minnkota.johnsonoutdoors.com.

- j. If the trolling motor has more than one external connector for an output device, complete the connection for that specific output and then follow the instructions for "Securing Accessory Cables" to complete the output cable installation.

NOTICE: If unsure of what features the trolling motor may be installed with that require connection to an output device, review the "Identifying Trolling Motor Features and Their Associated Cables" section in this document.

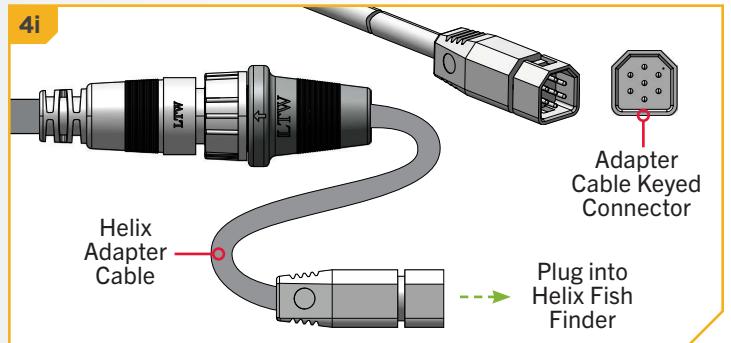
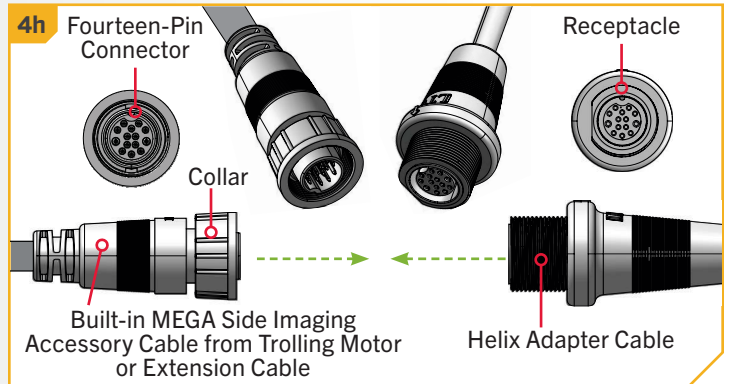

ADVANCED GPS NAVIGATION



ADVANCED GPS NAVIGATION >

Your Minn Kota trolling motor and Humminbird fish finder communicate with each other to change the way you fish. Advanced GPS Navigation offers a large array of features including controlling speed, steering, Spot-Lock, and the ability to record and retrace paths on the water, all at your fingertips. To learn more about the GPS capabilities available with your new motor, please refer to the Advanced GPS Navigation Owner’s Manual by visiting minnkota.johnsonoutdoors.com.

The Wireless Remote and GPS controller make up the Advanced GPS Navigation system. A Wireless Remote comes paired to the controller from the factory. The GPS controller contains a very sensitive compass and is where all GPS satellite and remote signals are received. The GPS controller is located in the trolling motor Control Head and may be connected to a fish finder from a connection cable that exits the Control Head. If the Advanced GPS Navigation system will be used with a fish finder, the Ethernet link between the trolling motor and the fish finder should be connected.

> Considerations for Connecting and Routing Advanced GPS Navigation

Advanced GPS Navigation is pre-installed on your trolling motor. One eight-pin Advanced GPS Ethernet Connector will exit the base of the Control Head and rest just below the Control Head next to the Coil Cord. If the Advanced GPS Navigation on the trolling motor will be used with a fish finder, an Ethernet Cable will need to be attached to the Advanced GPS Ethernet Connector below the Control Head. Consider the distance between the trolling motor and the fish finder to determine how to complete the Ethernet connection.

ETHERNET CABLES - Minn Kota provides one 30 ft Ethernet cable with every trolling motor equipped with Advanced GPS Navigation. The 30 ft Ethernet cable will accommodate a standard Ethernet connection for most installations to a Humminbird fish finder and is "Apex and Solix Ready."

HUMMINBIRD HELIX ADAPTER CABLES - Minn Kota provides one Helix Adapter Cable (**AS EC QDE - Ethernet Adapter Cable - 720074-1**) with every trolling motor equipped with Advanced GPS Navigation. If the Ethernet connection is being made between the trolling motor and any Humminbird® Helix fish finder, the Helix Adapter Cable should be used. The Helix Adapter Cable directly connects the Ethernet Cable to a Helix fish finder.

ETHERNET EXTENSION CABLES - If the 30 ft Ethernet cable provided with your trolling motor with Advanced GPS Navigation is not long enough to reach the fish finder, an Ethernet Extension cable should be used. The Ethernet Extension cable is available from humminbird.johnsonoutdoors.com and is available in a 30 ft length (**AS ECX 30E - 30' Ethernet Extension Cable - 760025-1**). The Ethernet Extension Cable will plug directly into any length of Ethernet cable.

NOTICE: Minn Kota recommends routing the Ethernet Cable or Ethernet Extension Cable through the Coil Cord when making the Ethernet connection. The cables will be installed from the Mount to the Control Head through the Coil Cord and parallel to the Dual Spectrum CHIRP or Built-in MEGA Side Imaging Cable. Bypassing the Coil Cord when routing the Ethernet Cable or Ethernet Extension Cable is not recommended.

 **CAUTION**

Failure to follow the recommended wire routing for installed features, if equipped, may cause damage to the product and void your product warranty. Route cables away from pinch points or other areas that may cause them to bend in sharp angles. Routing the cables in any way other than directed may cause damage to the cables by being pinched or severed. Do not over-tighten cable ties as it may damage the wires.

GPS Ethernet Connection

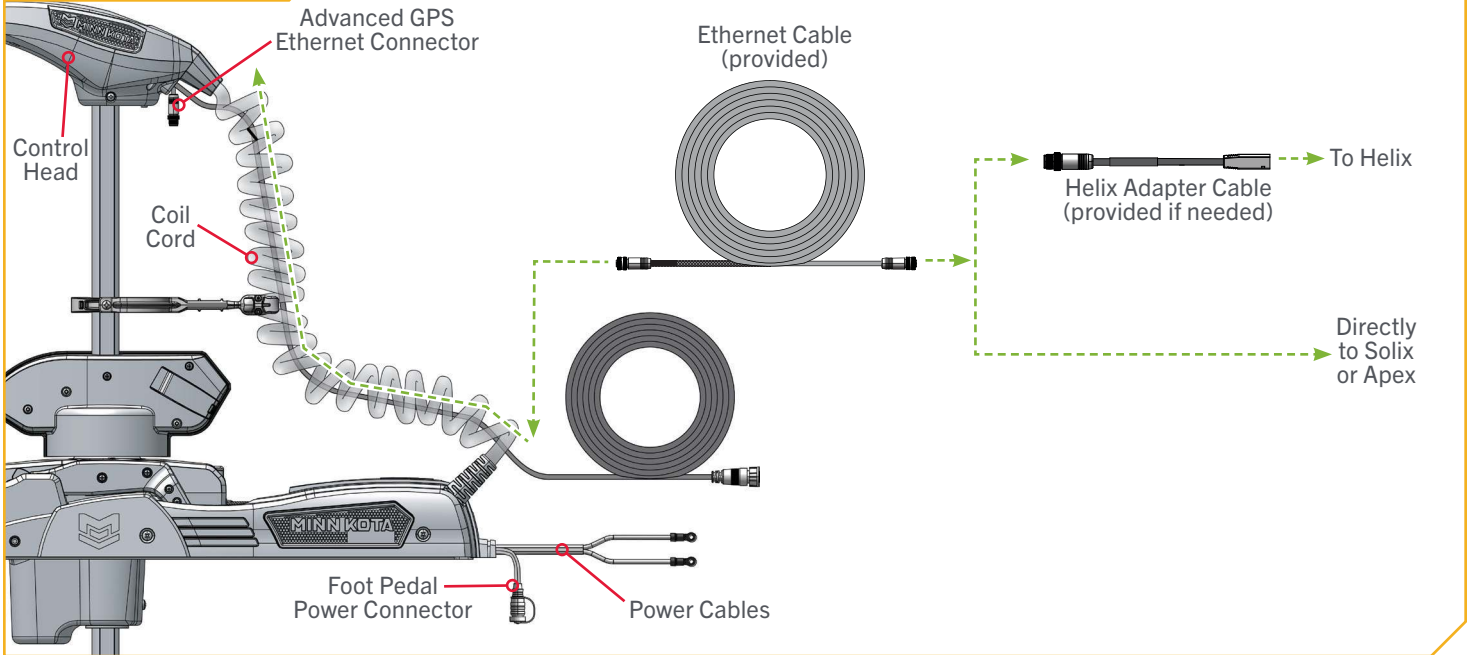

1

NOTICE: Your fish finder should be turned off until this procedure is complete.

NOTICE: For instructions on deploying the motor, see the “Stowing and Deploying the Ulterra QUEST” section of this manual.

- a. Place the motor in the deployed position.
- b. Locate the Eight-Pin Advanced GPS Ethernet Connector below the Control Head. The Advanced GPS Ethernet Connector will exit the base of the Control Head and will rest just below the Control Head next to the Coil Cord.

NOTICE: Ulterra QUEST trolling motors with Advanced GPS Navigation are also equipped with Sonar. Sonar is pre-installed from the factory and may be either Dual Spectrum CHIRP or Built-in MEGA Side Imaging. A Sonar Cable will run down the center of the Coil Cord. Review the “Identifying Trolling Motor Features and Their Associated Cables” of this document to identify and learn more about Sonar.

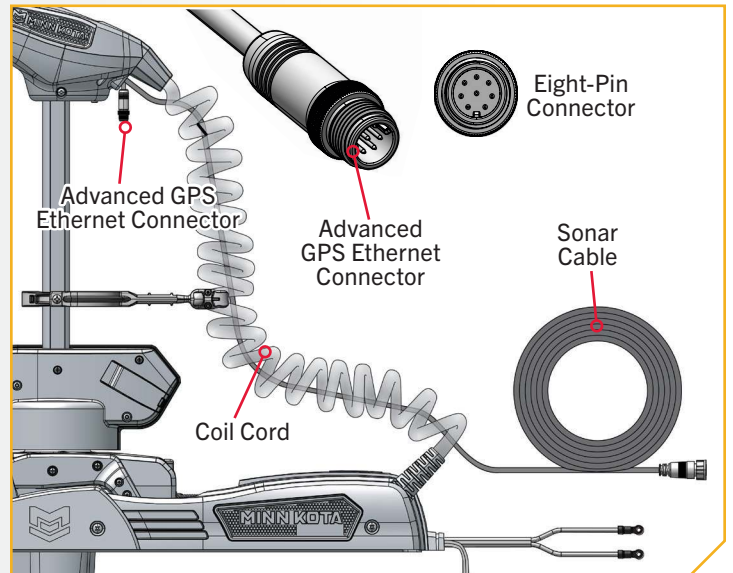

ADVANCED GPS NAVIGATION

2

ITEM(S) NEEDED

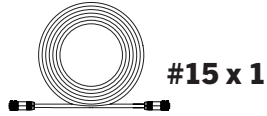

- c. Identify the keyed Receptacle on the Ethernet Cable (Item #15). It will be keyed to fit with the Eight-Pin Advanced GPS Ethernet Connector below the Control Head.

NOTICE: The Ethernet Cable has a Receptacle on both ends. The Receptacle on the end of the Ethernet Cable with braided sleeving should be connected to the Advanced GPS Ethernet Connector, while the Receptacle on the bare end without sleeving should be connected to the fish finder.

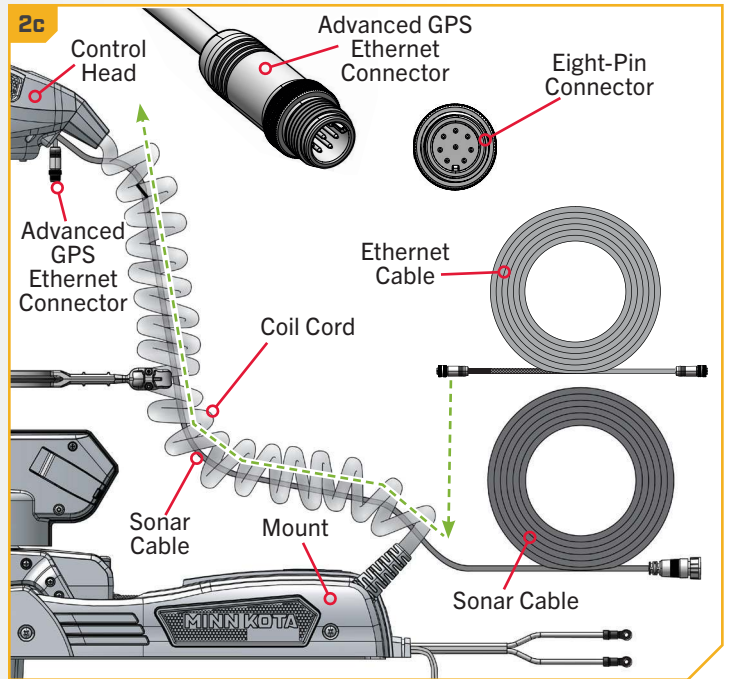
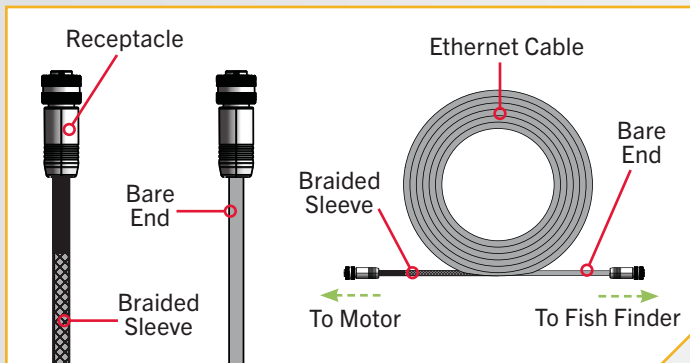

3

- d. Take the Receptacle on the end of the Ethernet Cable covered in a braided sleeve. The Receptacle with the braided sleeve will be inserted into the Coil Cord and connected to the Advanced GPS Ethernet Connector, while the Receptacle on the bare end of the Ethernet Cable will exit the Coil Cord and be connected to the Fish Finder.
- e. Run the Receptacle on the Ethernet Cable up through the bottom of the Coil Cord so it is parallel to the Sonar Cable. Allow enough slack in the cable to attach the Receptacle to the Advanced GPS Ethernet Connector.

NOTICE: Ensure that the correct Receptacle on the Ethernet Cable is routed through the Coil Cord and connected to the Advanced GPS Ethernet Connector. The section of the Ethernet Cable covered in a braided sleeve must be routed through the Coil Cord and connected. Do not connect the Receptacle on the bare end to the motor. Failure to connect the correct Receptacle may result in damage to cables.

NOTICE: Once all accessory cables are connected, the final installation will require the Ethernet Cable to be secured. See the “Securing Accessory Cables” section of this document for details once all connections are complete.

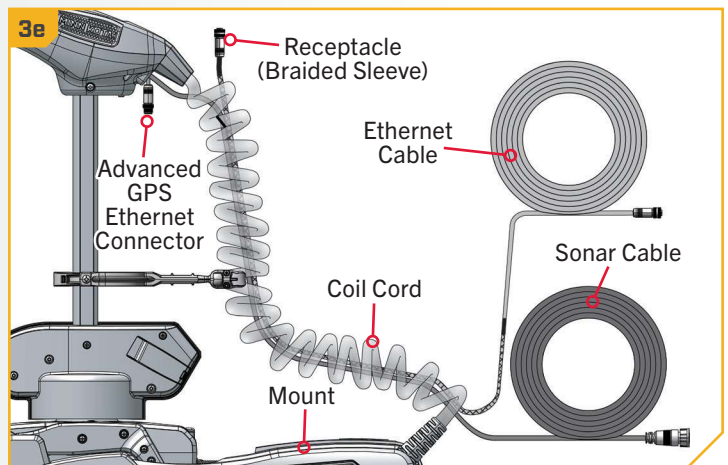
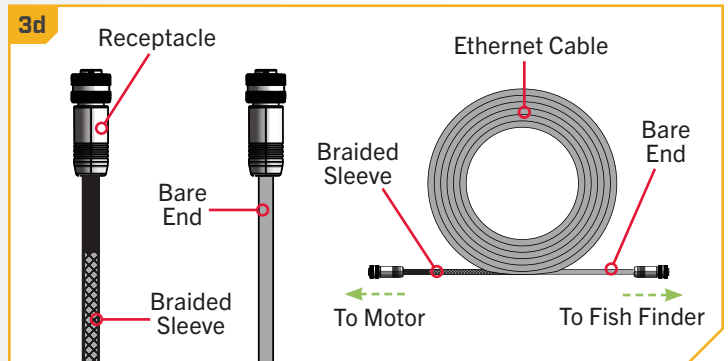

4

- f. **To install the Ethernet Cable**, align the pins on the Advanced GPS Ethernet Connector with the Receptacle on the Ethernet Cable. Notice the keyed connectors. Tighten the Collar from the Ethernet Cable to secure the connection.
- g. The Ethernet Cable will plug directly into a Solix or Helix Fish Finder or directly into a Helix Adapter Cable.

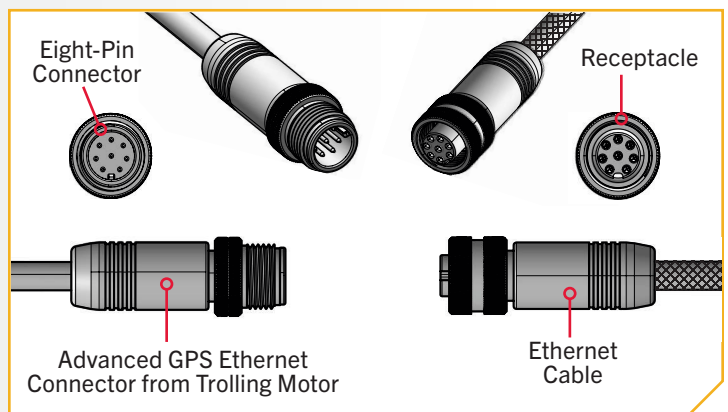

ADVANCED GPS NAVIGATION

5

- h. If installing directly to a Solix or Apex, the connector will be flat on the back of the fish finder display.
- i. Align the Receptacle on the Ethernet Cable with the Eight-Pin Connector on the Apex or Solix fish finder. Notice the keyed connectors. Tighten the Collar from the Ethernet Cable to secure the connection. Once directly installed to the Solix or Apex, the connection is complete.

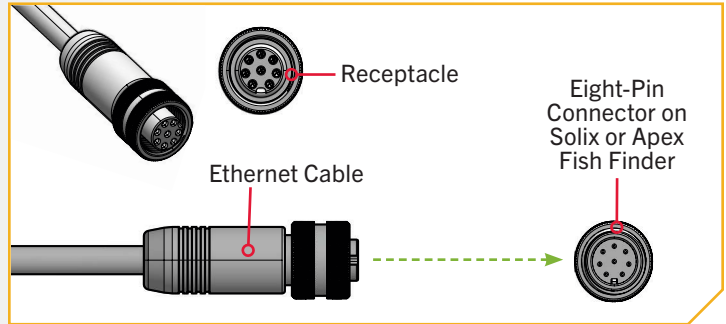

6

ITEM(S) NEEDED



- j. If installing directly to a Helix Adapter Cable (Item #16), align the Receptacle on the Ethernet Cable with the Eight-Pin Connector on the Helix Adapter Cable provided. Notice the keyed connectors. Tighten the Collar from the Ethernet Cable to secure the connection.

NOTICE: Minn Kota provides one Helix Adapter Cable (AS EC QDE - Ethernet Adapter Cable - 720074-1) with every trolling motor equipped with Advanced GPS Navigation.

- k. The Helix Adapter Cable directly connects the Ethernet Cable to a Helix fish finder. Locate the Helix Adapter Cable Keyed Connector on the back of the fish finder. Plug the Helix Adapter Cable into the back of the Helix fish finder to complete the connection.
- l. If the trolling motor has more than one feature that requires connection to an output device, complete the connection for that specific output and then follow the instructions for "Securing Accessory Cables" to complete the Accessory Cable installation.

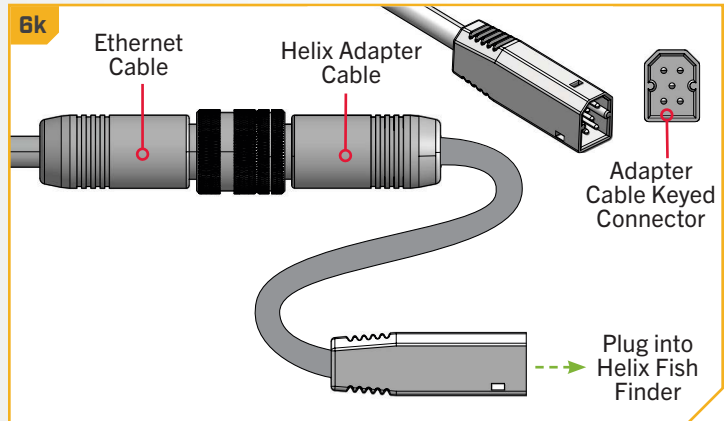
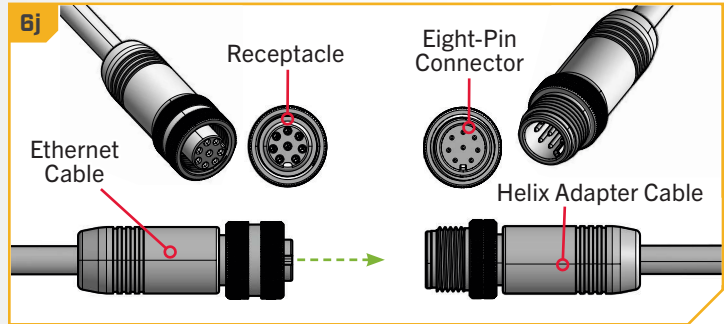

NOTICE: If unsure of what features the trolling motor may be installed with that require connection to an output device, please review the "Identifying Trolling Motor Features and Their Associated Cables" section of this manual.

Securing Accessory Cables

Before securing accessory cables, please review the "Identifying Trolling Motor Features and Their Associated Cables" section of this document. When identifying features, it is very important to secure the cables if **two** connections are present below the Control Head. If only **one** cable is present below the Control Head, securing the Accessory Cables is not necessary. All Accessory Cables that will be used on the trolling motor must be routed and all connections secured before completing the installation in this section. To review how feature cables should be routed and connected, review the "Advanced GPS Navigation" and "Dual Spectrum CHIRP" or "Built-in MEGA Side Imaging" sections of this document.

NOTICE: If only one cable is present below the Control Head, this installation is not applicable.

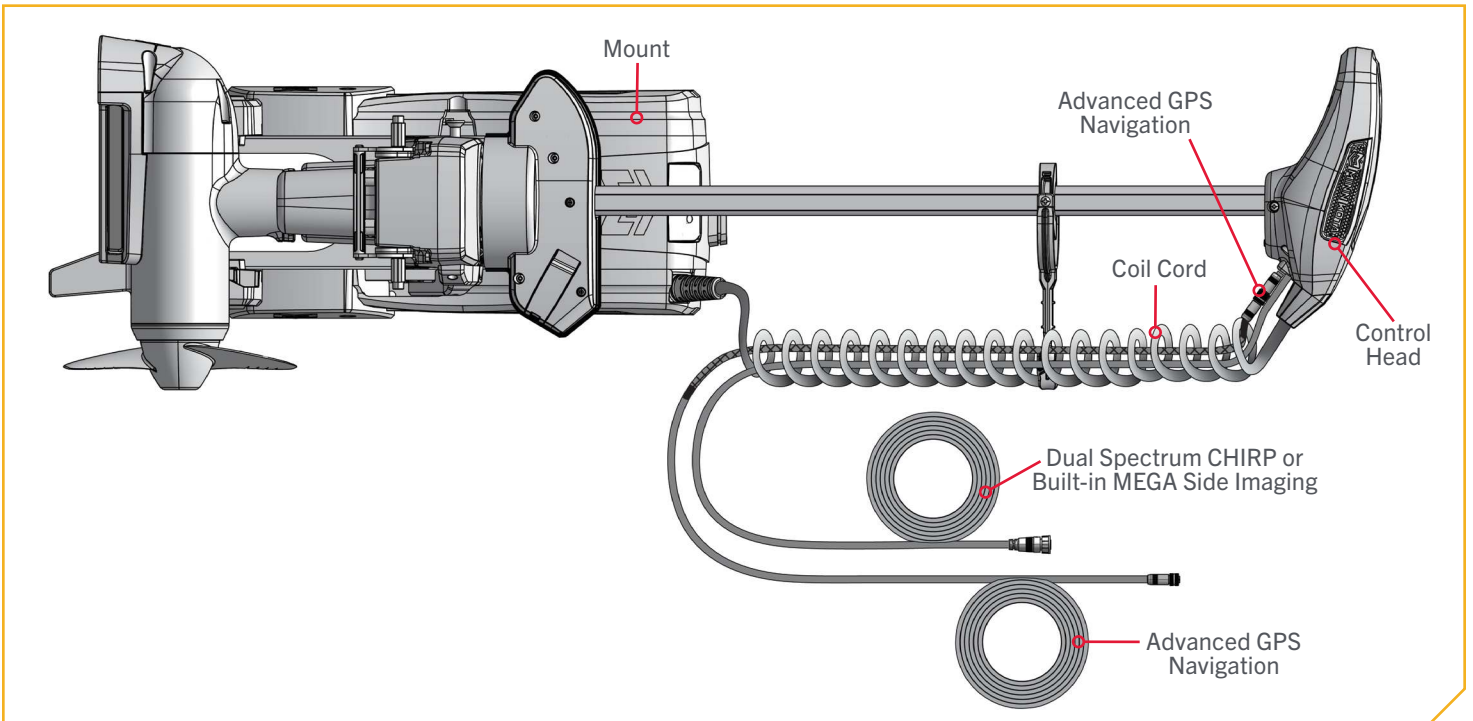

CAUTION

Failure to follow the recommended wire routing for installed features, if equipped, may cause damage to the product and void your product warranty. Route cables away from pinch points or other areas that may cause them to bend in sharp angles. Routing the cables in any way other than directed may cause damage to the cables by being pinched or severed. Do not over-tighten the cable tie as it may damage the wire.

SECURING ACCESSORY CABLES

1

ITEM(S) NEEDED



- a. Place the motor in the stowed position.

NOTICE: For instructions on stowing the motor, see the “Stowing and Deploying the Ultrerra QUEST” section of this manual.

- b. Confirm all Accessory Cables are connected to an output device as desired. With the motor stowed, locate the Advanced GPS Ethernet Connector below the Control Head.
- c. Take a Cable Tie (Item #17) and secure the Ethernet Cable to the second coil of the Coil Cord. The Cable Tie should wrap around the Ethernet Cable and Coil Cord, but not the Sonar Cable. Correct installation will have the Ethernet Cable and Sonar Cable each secured individually with a Cable Tie to the second coil of the Coil Cord.

NOTICE: The Sonar Cable comes from the factory secured to the Coil Cord with a Cable Tie. Do not remove or adjust the Cable Tie retaining the Sonar Cable.

- d. Secure the Cable Tie until it is fingertip tight. Do not over-tighten as it may damage the Ethernet Cable.
- e. Leave 6” of slack where the Sonar and Ethernet Cables exit the Coil Cord. Bundle any excess cable in a loose loop no less than 4” in diameter. The Reusable Cable Tie can be used to secure excess cable.

CAUTION

Do not over-tighten the Cable Tie as it may damage the wires.

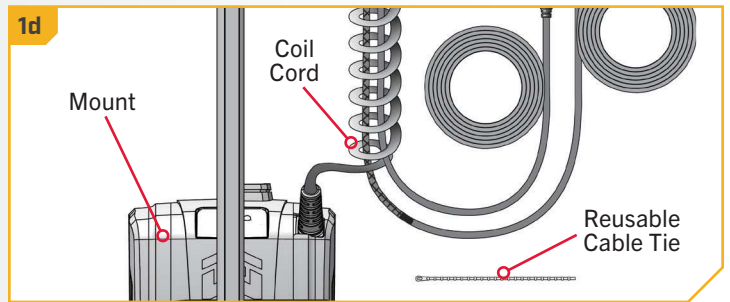
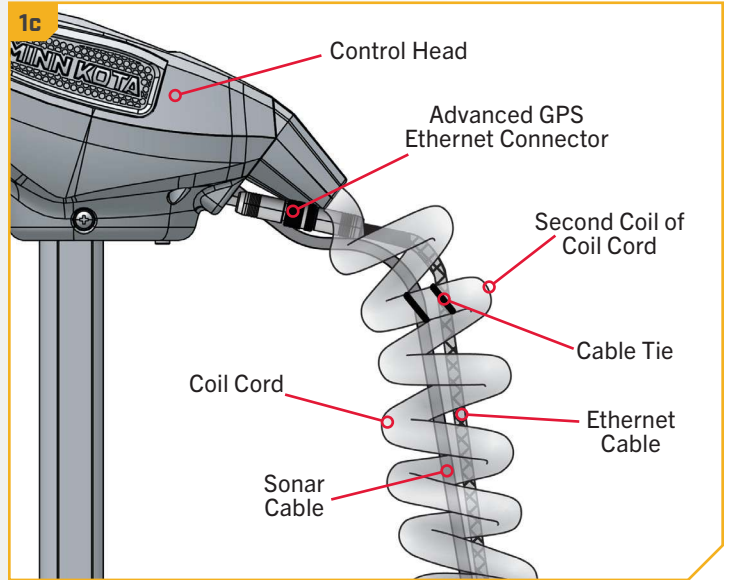

NOTICE: Minn Kota recommends routing the Accessory Cables through the Coil Cord. Bypassing the Coil Cord when routing Accessory Cables is not recommended.

NOTICE: The Ethernet Cable should be secured to the second coil of the Coil Cord. Securing the Ethernet Cable to any other coil may damage the Cables.

› Installing the Prop

1

ITEM(S) NEEDED

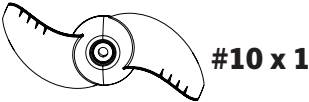

CAUTION

Disconnect the motor from the battery before beginning any Prop work or maintenance.

- a. Take the Drive Pin (Item #13) and slide it through the Hole in the Armature Shaft. Position the Drive Pin horizontally by grasping the Armature Shaft and rotating it with the Drive Pin in place.
- b. Align the Prop (Item #10) so it is horizontal and parallel with the Drive Pin. Slide the Prop onto the Armature Shaft and Drive Pin until it is seated against the lower unit.
- c. Install the Prop Washer (Item #11) and the Prop Nut (Item #12) onto the end of the Armature Shaft.
- d. While holding the Prop horizontal, tighten the Prop Nut with a 9/16" Deep Well Socket. Tighten the Prop Nut to 25-35 in-lb.

CAUTION

Do not over-tighten as this can damage the Prop.

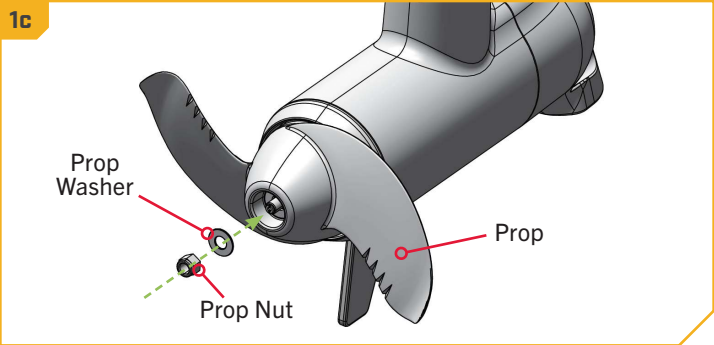
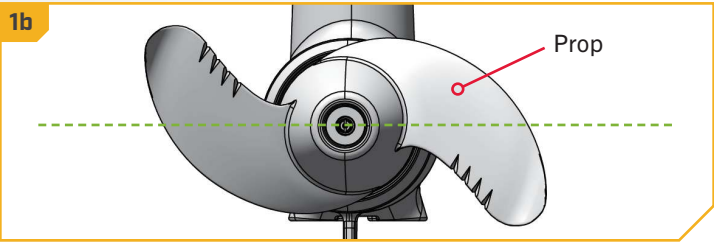
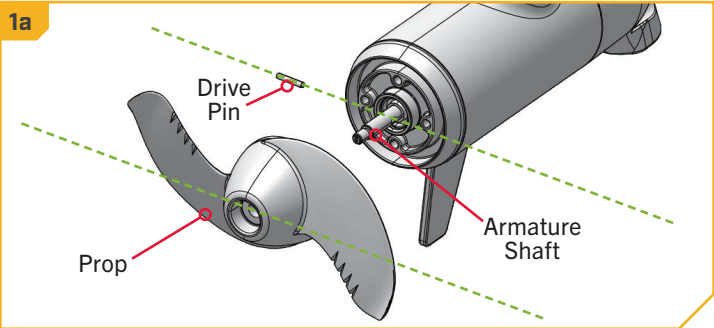

ONE-BOAT NETWORK

OPTIMIZING THE PERFORMANCE OF THE ULTERRA QUEST WITH THE WIRELESS REMOTE OR ONE-BOAT NETWORK APP

Minn Kota® and Humminbird® have joined forces to bring you the One-Boat Network, including the latest Advanced GPS Navigation Wireless Remote and the One-Boat Network app. The Wireless Remote comes from the factory paired to the trolling motor. To learn more about Wireless Remote features, refer to the Wireless Remote Owner's Manual online at minnkota.johnsonoutdoors.com.

To get the most from your One-Boat Network, we encourage you to download the One-Boat Network app onto your smart device. The One-Boat Network® app is a free iOS and Android application that you can download to a mobile device, providing unparalleled control over all of your One-Boat Network connected products. Minn Kota recommends connecting the trolling motor to the OBN app to assist in these steps. For instructions on pairing the OBN app to the trolling motor, refer to the OBN Quick Start Guide included with the motor. For more information on the OBN app, refer to the One-Boat Network Owner's Manual online at minnkota.johnsonoutdoors.com.

Completing the installation of the Ulterra QUEST through the Wireless Remote or OBN app should be done following the Prop installation. Ensure that the trolling motor is connected to a power source before adjusting One-Boat Network settings.

WARNING

Take care that neither you nor other persons approach the turning propeller too closely, neither with body parts nor with objects. The motor is powerful and may endanger or injure you or others. Stay clear of the Prop and watch out for accidental engagement.

NOTICE: Ensure that the trolling motor is connected to a power source before adjusting One-Boat Network settings.

NOTICE: If the Wireless Remote is lost or becomes non-functioning during navigation, and the One-Boat Network app is unavailable, disconnect the motor from power to cancel all active navigation and turn off the Prop.

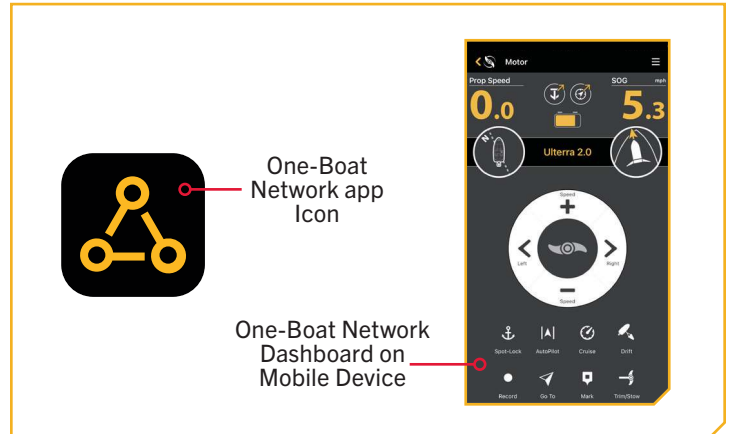

ONE-BOAT NETWORK ADJUSTMENTS



KEEL OFFSET

The Ultrera QUEST comes from the factory with the Lower Unit parallel to the Mount. When the Lower Unit is parallel to the Mount, the Keel Offset is zero. In an ideal installation, the Lower Unit will be parallel to the Keel; however, the Mount is rarely installed to be perfectly inline with the Keel, therefore the Lower Unit will not be parallel with the Keel. Nearly all installations will have some variation in mounting position to either the Port or Starboard side of the boat. The Keel Offset feature records the position of the Lower Unit when it is parallel to the Keel based on the Mount being offset from the Keel. Before adjusting the Keel Offset, complete all installation steps. This includes mounting the trolling motor to the boat and installing power and accessory cables. The Keel Offset can be recorded through the Wireless Remote or One-Boat Network App.

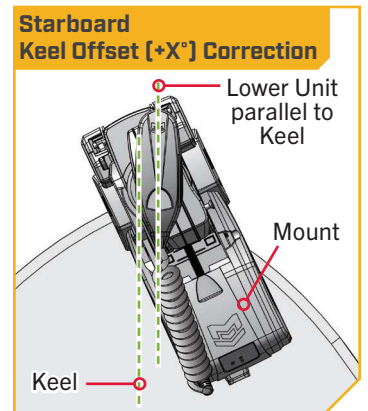
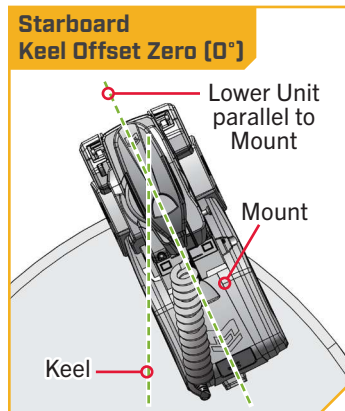
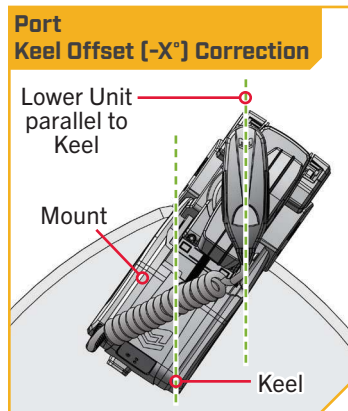
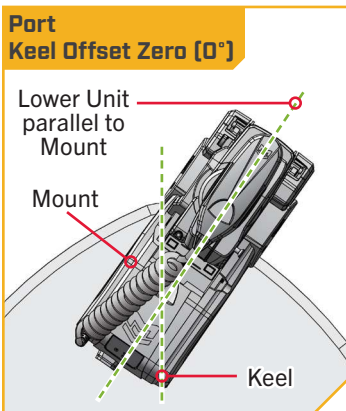
NOTICE: When the motor is installed from the factory, the Keel Offset is 0 degrees. When adjusting the Keel Offset, any position towards Port will create a Keel Offset of a negative angle. Any position towards Starboard will create a positive angle.







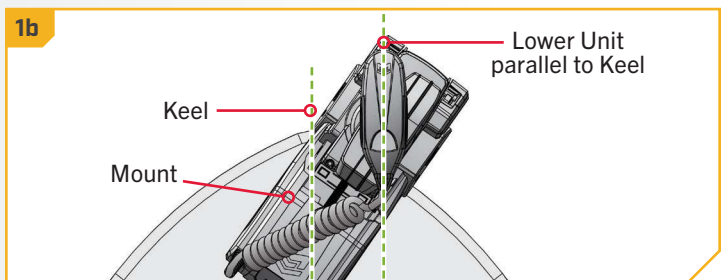
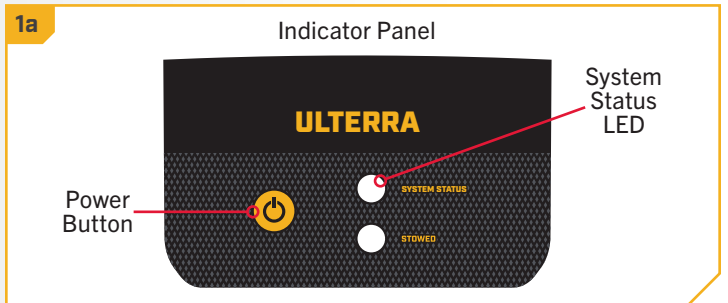



Setting the Keel Offset with the Wireless Remote

1.
 - a. Power on the trolling motor by pressing the Power  button on the Indicator Panel. When the trolling motor is on, the System Status  LED will be blue.
 - b. With either the Wireless Remote, foot pedal, or One-Boat Network (OBN) app on a paired mobile device, steer the motor so that the control head and lower unit are parallel to the Keel.







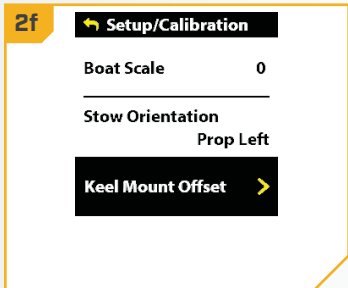
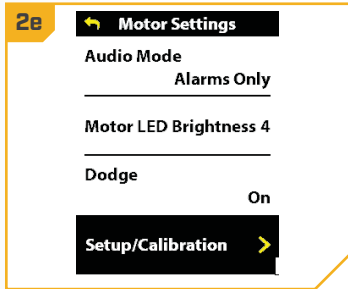
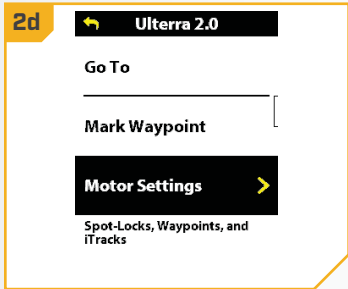

KEEL OFFSET

2

- c. Press the Menu  button on the Wireless Remote.
- d. Use the Speed Up  or Speed Down  button to find the Motor Settings menu. Use the Steer Right  button to select Motor Settings.
- e. In the Motor Settings Menu, use the Speed Up  or Speed Down  button to find Setup/Calibration.
- f. In the Setup/Calibration menu, use the Speed Up  or Speed Down  button to find Keel Mount Offset. Use the Steer Right  button to select Keel Mount Offset.



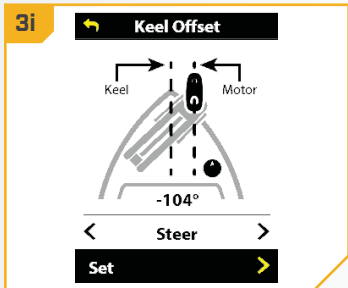
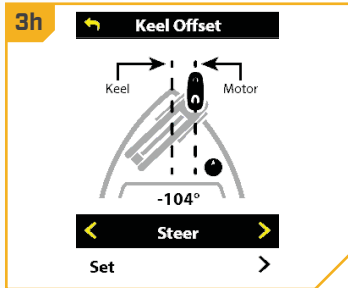
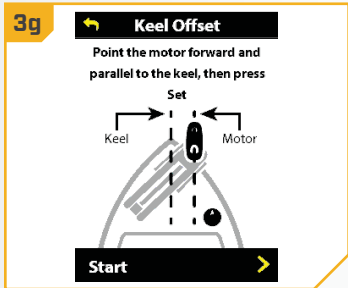

3

- g. Review all safety warnings. Use the Steer Right  button to select Start and begin the process.
- h. Use the Steer Left  or Steer Right  button to point the motor forward and parallel to the keel.
- i. When satisfied with the placement of the trolling motor, use the Speed Up  or Speed Down  button to scroll to Set. Use the Steer Right  button to select Set. The degree of offset is displayed at the bottom of the Dashboard.



▶ Setting the Keel Offset with the One-Boat Network App

1

- a. Power on the trolling motor by pressing the Power  button on the Indicator Panel. When the trolling motor is on, the System Status  LED will be blue.
- b. With either the Wireless Remote, foot pedal, or One-Boat Network (OBN) app on a paired mobile device, steer the motor so that the control head and lower unit are parallel to the Keel.

1a

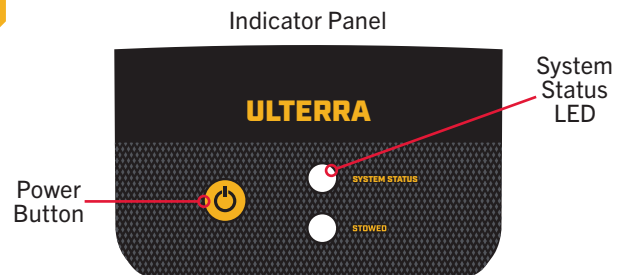

1b

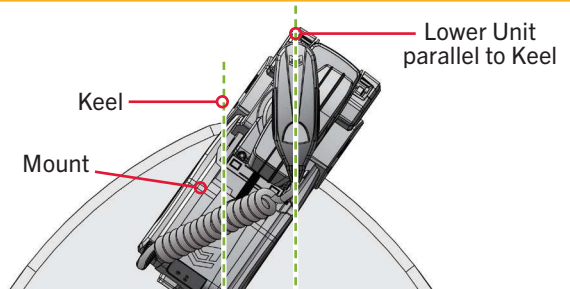

2

- c. Open the One-Boat Network (OBN) app on the mobile device. Make sure the mobile device is paired with the trolling motor.
- d. From the OBN home screen, tap the Motor menu. The Motor menu opens the Motor home screen.
- e. Before the Motor home screen will open, tap Agree on the on-screen prompt.

NOTICE: The on-screen prompt will only display once each time the app is launched. If the prompt has displayed, the Motor home screen appears.

- f. On the Motor home screen, locate the Motor Settings button in the upper-right corner and tap it.

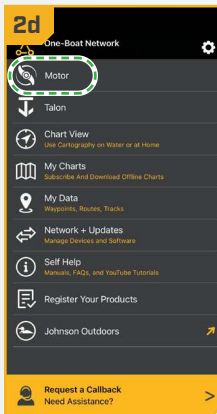

KEEL OFFSET

3

- g. In the Motor Settings menu, find and tap Setup and Calibration.
- h. In Setup and Calibration, find and tap Keel Mount Offset.
- i. Review all safety warnings. Follow the prompts in the One-Boat Network app. If the placement of the trolling motor is pointing forward and parallel to the keel, tap Set. The degree of offset will show at the bottom of the app Display.

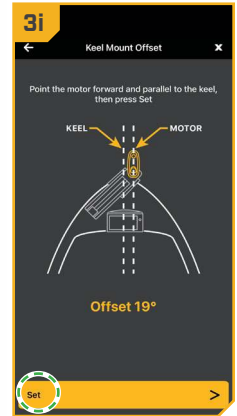
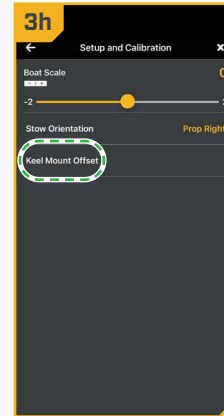
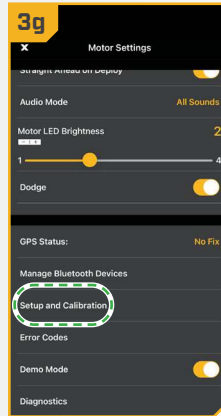

4

- j. If the trolling motor needs to be adjusted, locate the Return button on the upper-left corner of the app screen. Tap the Return button three times until the Motor home screen displays.
- k. Use the Steer Right > and Steer Left < buttons to point the motor forward and parallel to the keel.
- l. When satisfied with the placement of the trolling motor, locate the Motor Settings button in the upper-right corner and tap it.
- m. In the Motor Settings menu, find and tap Setup and Calibration.
- n. In Setup and Calibration, find and tap Keel Mount Offset. If the placement of the trolling motor is pointing forward and parallel to the keel, tap Set.
- o. The degree of offset shows at the bottom of the app Display. Tap Return to close the Keel Mount Offset and return to the home screen.

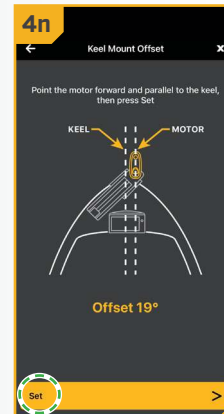
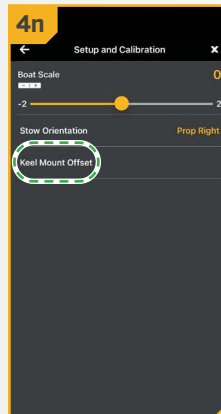
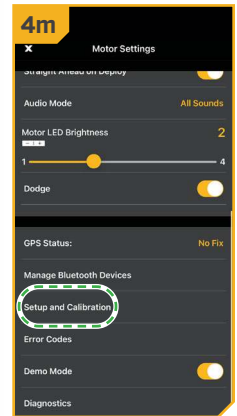

STRAIGHT ON DEPLOY

Minn Kota recommends setting the Keel Offset when the position of the Lower Unit is parallel with the Keel. Save the Keel Offset before exploring the Straight on Deploy feature. Straight on Deploy uses the position recorded in Keel Offset to know where to position the Lower Unit to be parallel with the Keel.

When Straight on Deploy is engaged, the lower unit will automatically rotate to the Keel Offset position when deployed. By default, the Lower Unit will be parallel to the Keel when the Mount is parallel to the Keel. If the Keel Offset was programmed to another angle, the Straight on Deploy feature will correct the position to match the Keel Offset angle when turned "on." If Straight on Deploy is turned "off," the trolling motor will not correct the position in any direction.

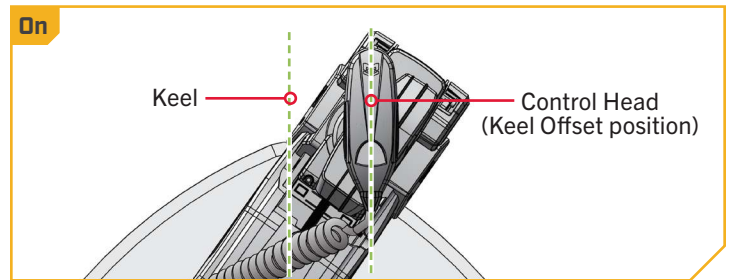
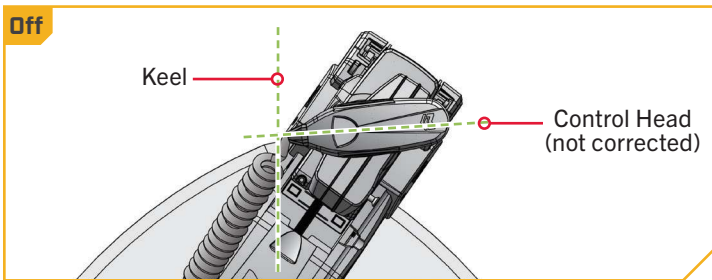

› To Toggle Straight on Deploy with the Wireless Remote

- 1**
 - a. With the motor on, press the Menu button on the Wireless Remote.
 - b. Use the Speed Up or Speed Down button to find the Motor Settings menu. Use the Steer Right button to select Motor Settings.
 - c. In the Motor Settings Menu, use the Speed Up or Speed Down button to find Straight on Deploy.
 - d. By default, the Straight on Deploy is toggled "off."
 - e. Use the Steer Right button to toggle between "on" and "off."

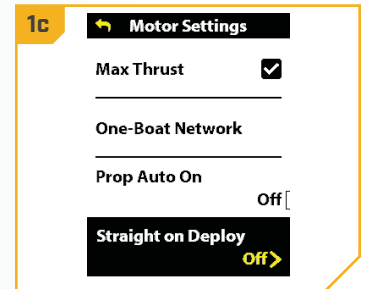
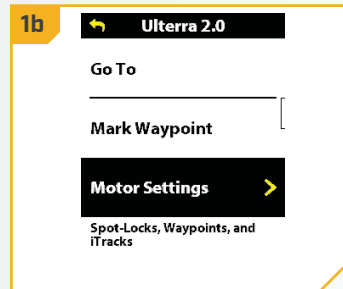

STRAIGHT ON DEPLOY

› To Toggle Straight on Deploy with the One-Boat Network App

1

- Open the One-Boat Network (OBN) app on a mobile device. Make sure the mobile device is paired with the trolling motor and that the motor is powered "on."
- From the OBN home screen, tap the Motor menu. The Motor menu opens the Motor home screen.
- Before the Motor home screen will open, tap Agree on the on-screen prompt.

NOTICE: The on-screen prompt will only display once each time the app is launched. If the prompt has displayed, the Motor home screen appears.

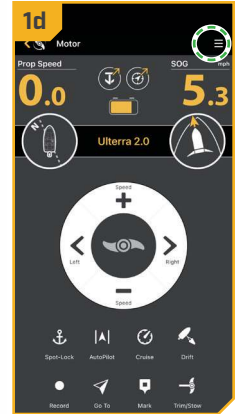
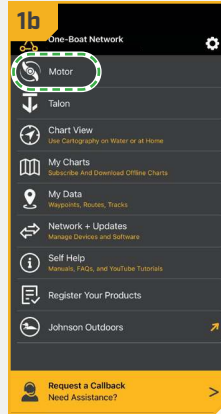

- On the Motor home screen, locate the Motor Settings button in the upper-right corner and tap it.

2

- In the Motor Settings menu, find the Straight Ahead on Deploy toggle. Tap to turn the toggle "on" and "off." When highlighted yellow the toggle is "on."

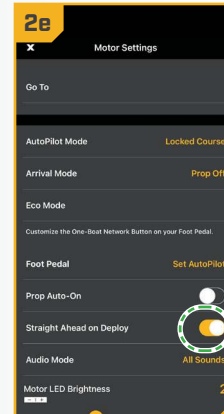
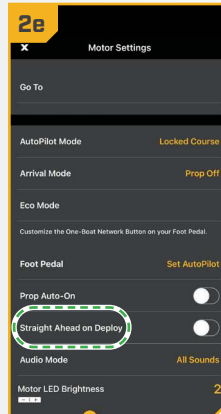

STOW ORIENTATION

The Stow Orientation is a term used to describe the lower unit and Prop position when the motor is stowed. The lower unit will automatically rotate into the Stow Orientation when stowing the motor. The Stow Orientation can be set to Prop Left or Prop Right through the Wireless Remote or One-Boat Network app. The factory default setting for the lower unit is Prop Left. Adjusting the Stow Orientation allows the installation to be customized to fit boat positioning for either a Port or Starboard installation and to accommodate fishing or trailering applications.

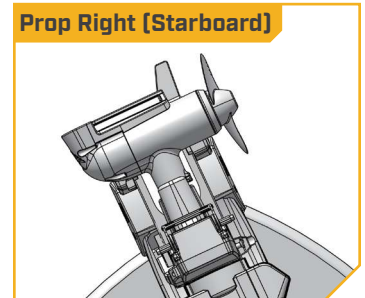
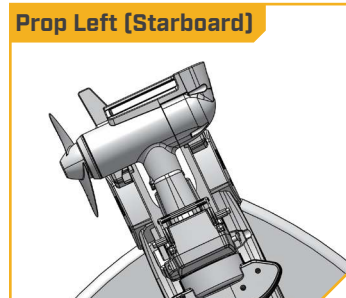
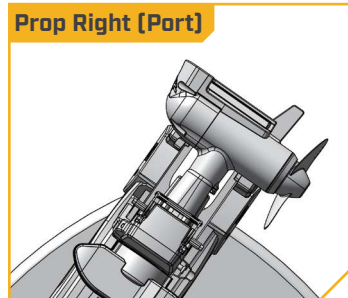
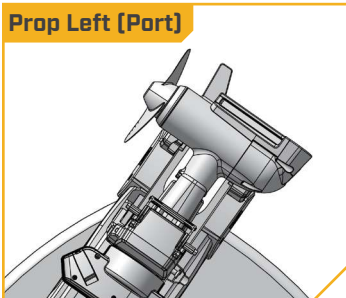

Setting the Stow Orientation with the Wireless Remote

- 1**
 - a. With the trolling motor powered on, press the Menu button on the Wireless Remote.
 - b. Use the Speed Up or Speed Down button to find the Motor Settings menu. Use the Steer Right button to select Motor Settings.
 - c. In the Motor Settings Menu, use the Speed Up or Speed Down button to find Setup/Calibration. Use Steer Right to open the Setup/Calibration menu.

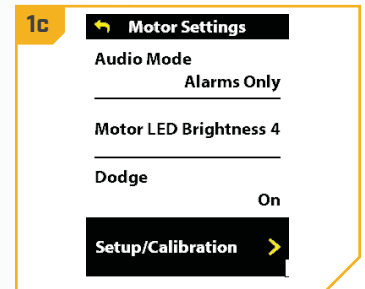
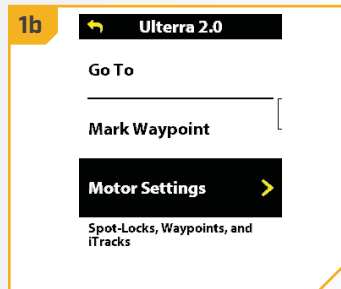

- 2**
 - d. Once in the Setup/Calibration menu, use the Speed Up or Speed Down button to find Stow Orientation. Use Steer Right to open the Stow Orientation menu.
 - e. In the Stow Orientation menu, use the Speed Down or Speed Up button to scroll between Prop Left and Prop Right. Use the Steer Right button to select the desired stow orientation.

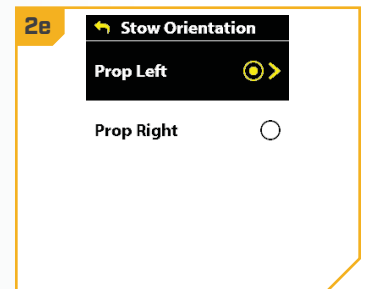
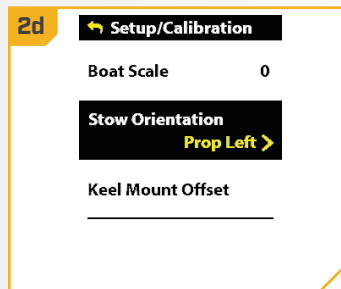

STOW ORIENTATION

Setting the Stow Orientation with the One-Boat Network App

1

- a. Open the One-Boat Network (OBN) app on a mobile device. Make sure the mobile device is paired with the trolling motor and that the motor is powered "on."
- b. From the OBN home screen, tap the Motor menu. The Motor menu opens the Motor home screen.
- c. Before the Motor home screen will open, tap Agree on the on-screen prompt.

NOTICE: The on-screen prompt will only display once each time the app is launched. If the prompt has displayed, the Motor home screen appears.

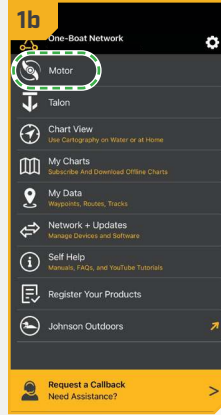

- d. On the Motor home screen, locate the Motor Settings button in the upper-right corner and tap it.

2

- e. In the Motor Settings menu, find and tap Setup and Calibration.
- f. In Setup and Calibration, find and tap Stow Orientation.
- g. Set the feature to Prop Right or Prop Left.

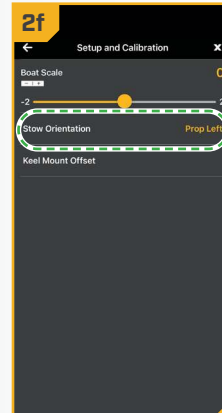
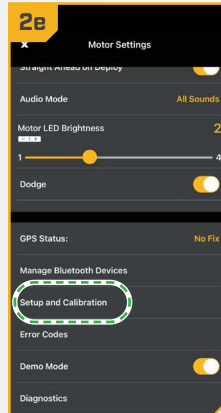







BOAT SCALE





Trolling motor performance can be impacted by factors including, but not limited to, wind, water conditions, boat specifications, battery health, wiring, etc. Boat Scale provides a method of adjusting how the trolling motor will perform to account for these and other variables. The Ulterra QUEST comes from the factory with Boat Scale set to zero. Boat Scale can be adjusted up (+2) or down (-2) to increase or decrease how the motor control software applies power while using a navigation mode like Spot-Lock.

An example showing the need to reduce Boat Scale would be while using Spot-Lock and the motor is over-correcting or making frequent adjustments. In this case, try reducing Boat Scale -1 to reduce this behavior. If the behavior continues, reduce Boat Scale to -2. An example showing the need to increase Boat Scale while using Spot-Lock would be the motor is drifting away from its target location frequently or needs help to make corrections. Try increasing Boat Scale to +1 to help improve the trolling motor accuracy in this case. If the behavior continues, increase Boat Scale to +2.

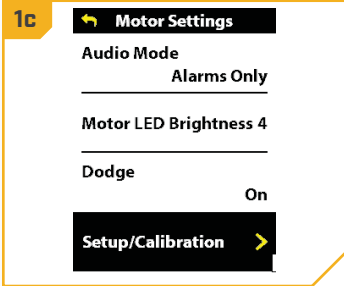
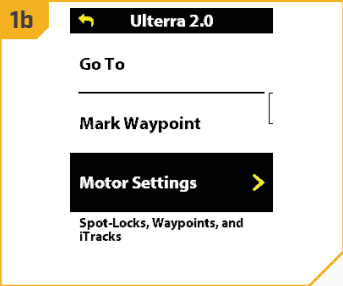
Adjusting Boat Scale with the Wireless Remote

- 1 a. With the motor on, press the Menu  button on the Wireless Remote.
- b. Use the Speed Up  or Speed Down  button to find the Motor Settings menu. Use the Steer Right  button to select Motor Settings.
- c. In the Motor Settings Menu, use the Speed Up  or Speed Down  button to find Setup/Calibration.



- 2 d. Once in the Setup/Calibration menu, use the Speed Up  or Speed Down  button to find Boat Scale.
- e. Use the Steer Left  or Steer Right  button to adjust the Boat Scale to one of the five settings: -2, -1, 0, 1 or 2.

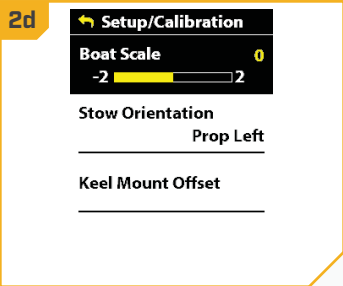

BOAT SCALE

▶ Adjusting Boat Scale with the One-Boat Network App

1

- Open the One-Boat Network (OBN) app on a mobile device. Make sure the mobile device is paired with the trolling motor and that the motor is powered "on."
- From the OBN home screen, tap the Motor menu. The Motor menu opens the Motor home screen.
- Before the Motor home screen will open, tap Agree on the on-screen prompt.

NOTICE: The on-screen prompt will only display once each time the app is launched. If the prompt has displayed, the Motor home screen appears.

- On the Motor home screen, locate the Motor Settings button in the upper-right corner and tap it.

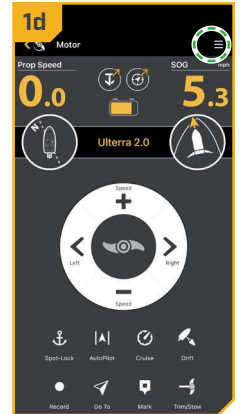
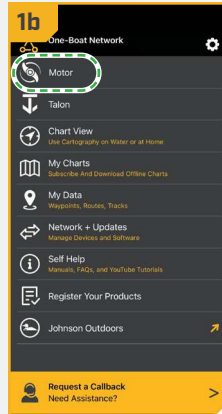

2

- In the Motor Settings menu, find and tap Setup and Calibration.
- In Setup and Calibration, find and tap Boat Scale.
- Set the feature to increase or decrease Boat Scale.

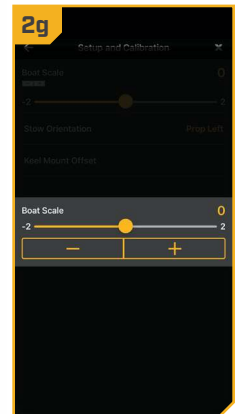
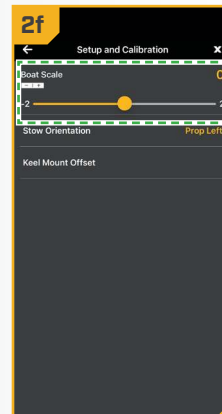
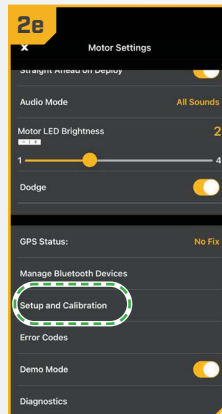

ONE-BOAT NETWORK BUTTONS

ONE-BOAT NETWORK BUTTONS

Minn Kota trolling motors equipped with Advanced GPS Navigation are compatible with devices enabled with the One-Boat Network (OBN), such as the Wireless Remote and Foot Pedal. OBN functions can be enabled and disabled through customizable OBN buttons on the Wireless Remote and Foot Pedal. The function of the OBN buttons can be customized based on user preference to enhance operation of the OBN product. Customizable OBN buttons include:

1. The four One-Boat Network buttons on the Wireless Remote
2. The One-Boat Network button on the Foot Pedal

CUSTOMIZING THE ONE-BOAT NETWORK BUTTONS ON THE WIRELESS REMOTE

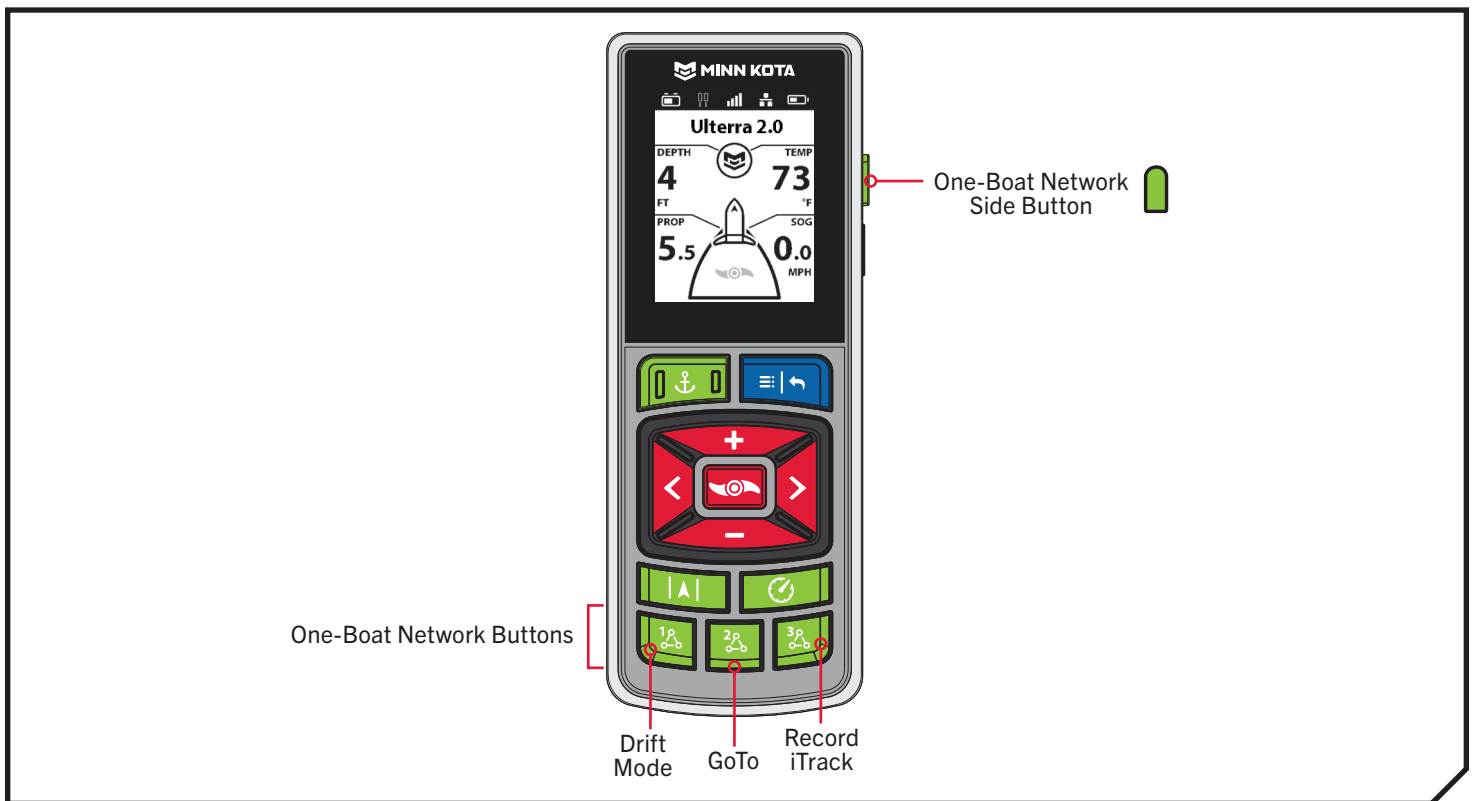







One-Boat Network Default Buttons

	Drift Mode		Record iTrack
	GoTo		Deployment Mode

CUSTOMIZING THE ONE-BOAT NETWORK BUTTONS ON THE WIRELESS REMOTE



One-Boat Network functions can be enabled and disabled through four One-Boat Network buttons on the Wireless Remote. The One-Boat Network buttons can be customized to control the following functions, depending on your setup:











Function	Icon	Description
Drift Mode		Drift mode is the default function for OBN Button 1. Press once to engage Drift Mode. Press a second time to Adjust Course.
Go To		Go To is the default for the OBN Button 2. Press once to open the Go To Menu. The Go To options are Spot-Locks, Waypoints, iTracks and Drift.
Record iTrack		Record iTrack is the default function for OBN Button 3. Press once to start recording an iTrack. Press a second time to save the iTrack.
Waypoint		Mark Waypoint must first be customized to one of the OBN buttons. Press once to save a Waypoint.
Max Speed		Max Speed must first be customized to one of the OBN buttons. Double press to engage Max Speed. Single press to return to the previous speed.
Talon/Raptor		The shallow water anchor function must first be customized to one of the OBN buttons. The shallow water anchor function will display as Talon or Raptor depending on your configuration. Double press to deploy the anchor. Press once to pause or stow the anchor.
Deployment Mode		Deployment Mode is the default function for the OBN Side Button on trolling motors with a stow/deploy and trim function. The Deployment Mode function will display as Ulterra. Press the OBN Side Button once to bring up the Ulterra menu.



CUSTOMIZING THE ONE-BOAT NETWORK BUTTONS ON THE WIRELESS REMOTE





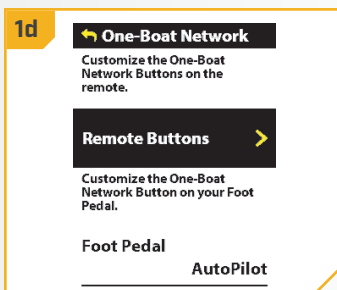
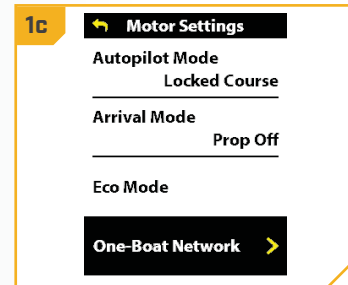
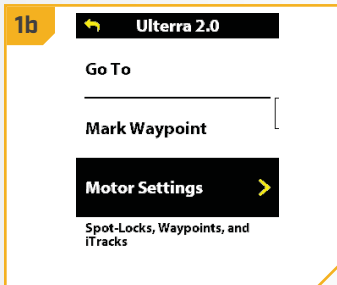

› Customize the One-Boat Network Buttons on the Wireless Remote

1

- a. On the Wireless Remote, press the Menu  button to open the Motor Menu.
- b. In the Motor Menu, use the Speed Down  or Speed Up  button to find the Motor Settings menu. Use the Steer Right  button to select Motor Settings.
- c. In the Motor Settings menu, use the Speed Down  or Speed Up  button to find One-Boat Network. Use the Steer Right  button to select One-Boat Network.
- d. In the One-Boat Network Menu, use the Speed Down  or Speed Up  button to find Remote Buttons. Use the Steer Right  button to select Remote Buttons.



2

- e. Use the Speed Down  or Speed Up  button to highlight the OBN button to customize. There are four options: Button 1, Button 2, Button 3 or Side Button. Press the Steer Right  button to make the selection.
- f. Use the Speed Down  or Speed Up  button to scroll through the options. Use the Steer Right  button to select the function.

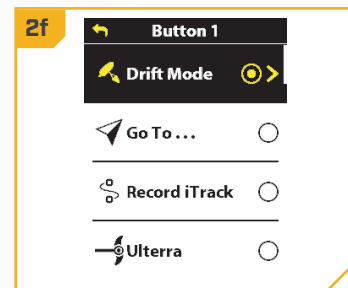
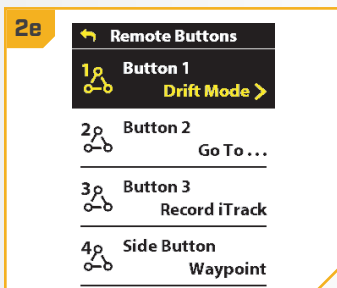

NOTICE: The radio button next to the desired function will be selected when the Steer Right  button is used to customize the function. The function options listed are based on the trolling motor and other devices in the Advanced GPS Navigation network.

NOTICE: For quick customization, press and hold the OBN button you want to customize to quickly bring up the customization screen.

- g. Press and hold the Menu  button to close and return to the Home Screen.

CUSTOMIZING THE ONE-BOAT NETWORK BUTTON ON THE FOOT PEDAL

CUSTOMIZING THE ONE-BOAT NETWORK BUTTON ON THE FOOT PEDAL



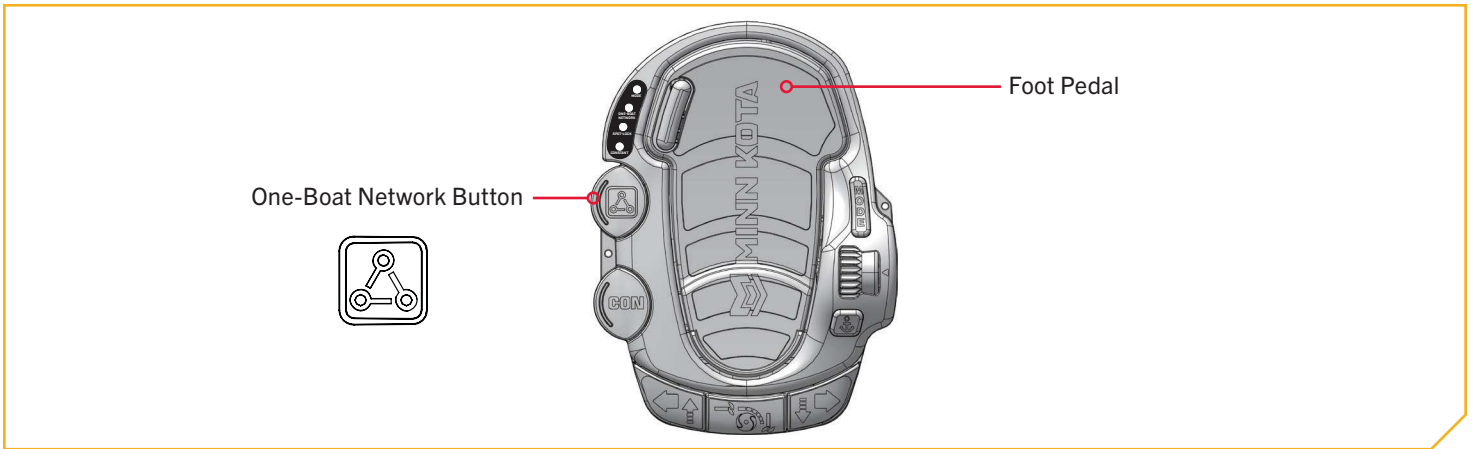



Minn Kota trolling motors equipped with Advanced GPS Navigation are compatible with devices enabled with the One-Boat Network, such as the Foot Pedal. One-Boat Network functions are enabled and disabled through the Foot Pedal with the One-Boat Network  button. This button can be customized using either the Wireless Remote or the One-Boat Network app on a paired mobile device.



The One-Boat Network  button on the Foot Pedal can be customized to control the following functions:

Function	Operation	LED Indication
AutoPilot (default)	Engage and disengage AutoPilot	Red LED will illuminate when AutoPilot is engaged and stay on until disengaged.
Waypoint	Mark a Waypoint	Red LED will illuminate when the One-Boat Network button is pressed and then turn off, signaling that a Waypoint was marked.
Shallow Water Anchor (Raptor/Talon)	Deploy and retract a Raptor/Talon	Red LED will steadily flash when the Shallow Water Anchor is deploying or stowing. Red LED will stay illuminated when the anchor is at any state of deployment, including when it is paused. Red LED will turn off when the anchor is fully stowed.





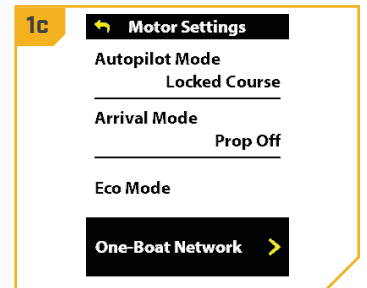
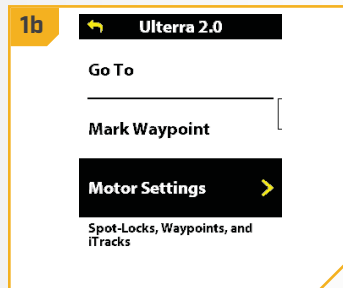

› Customize the OBN Button on the Foot Pedal with the Wireless Remote

- 1** a. With the trolling motor powered on, press the Menu  button on the Wireless Remote.
- b. In the Motor Menu, use the Speed Down  or Speed Up  button to find the Motor Settings menu. Use the Steer Right  button to select Motor Settings.
- c. In the Motor Settings menu, use the Speed Down  or Speed Up  button to find One-Boat Network. Use the Steer Right  button to select One-Boat Network.



CUSTOMIZING THE ONE-BOAT NETWORK BUTTON ON THE FOOT PEDAL

2

- d. In the One-Boat Network menu, use the Speed Down  or Speed Up  button to find Foot Pedal. Use the Steer Right  button to select Foot Pedal.
- e. In the Foot Pedal menu, use the Speed Down  or Speed Up  button to find the desired function. Use the Steer Right  button to select the function.
- f. Press and hold the Menu  button to close and return to the Home Screen.

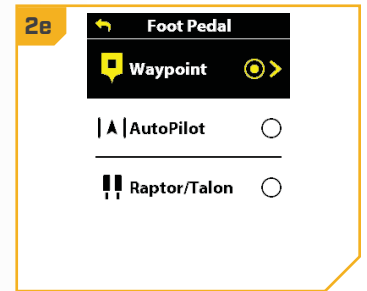
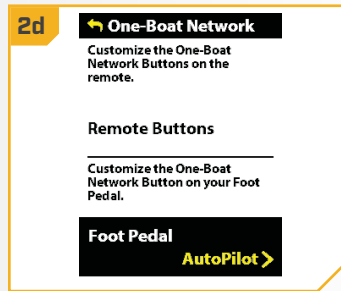

NOTICE: The radio button next to the desired function will be selected when the Steer Right  button is used to customize the function. AutoPilot is the default selection for Ulterra QUEST trolling motors. The function options listed are based on the trolling motor and other devices in the Advanced GPS Navigation network.

Customize the OBN Button on the Foot Pedal with the One-Boat Network App

1

- a. Open the One-Boat Network (OBN) app on a mobile device. Make sure the mobile device is paired with the trolling motor and that the motor is powered “on.”
- b. From the OBN home screen, tap the Motor menu. The Motor menu opens the Motor home screen.
- c. Before the Motor home screen will open, tap Agree on the on-screen prompt.
- d. On the Motor home screen, locate the Motor Settings button in the upper-right corner and tap it.

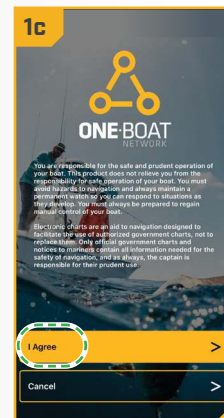
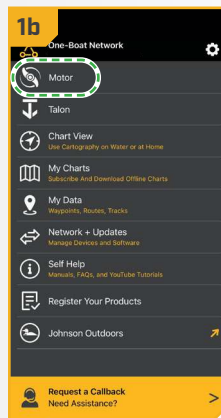

2

- e. **On an Android:** in the Motor Settings menu, locate “One-Boat Network Button” and tap it.
- f. **On iOS:** in the Motor Settings menu, locate Foot Pedal and tap it.
- g. Tap the desired function. The radio button next to the selected function will be highlighted.

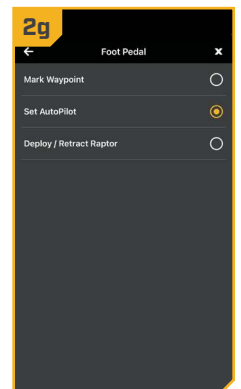
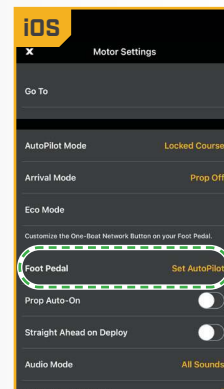
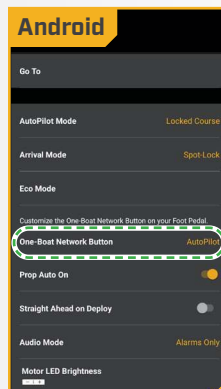

MOTOR WIRING DIAGRAM

ULTRERA QUEST

The following Motor Wiring Diagram applies to all Ultrera QUEST models. Sonar is either Dual Spectrum CHIRP or Built-in MEGA Side Imaging.

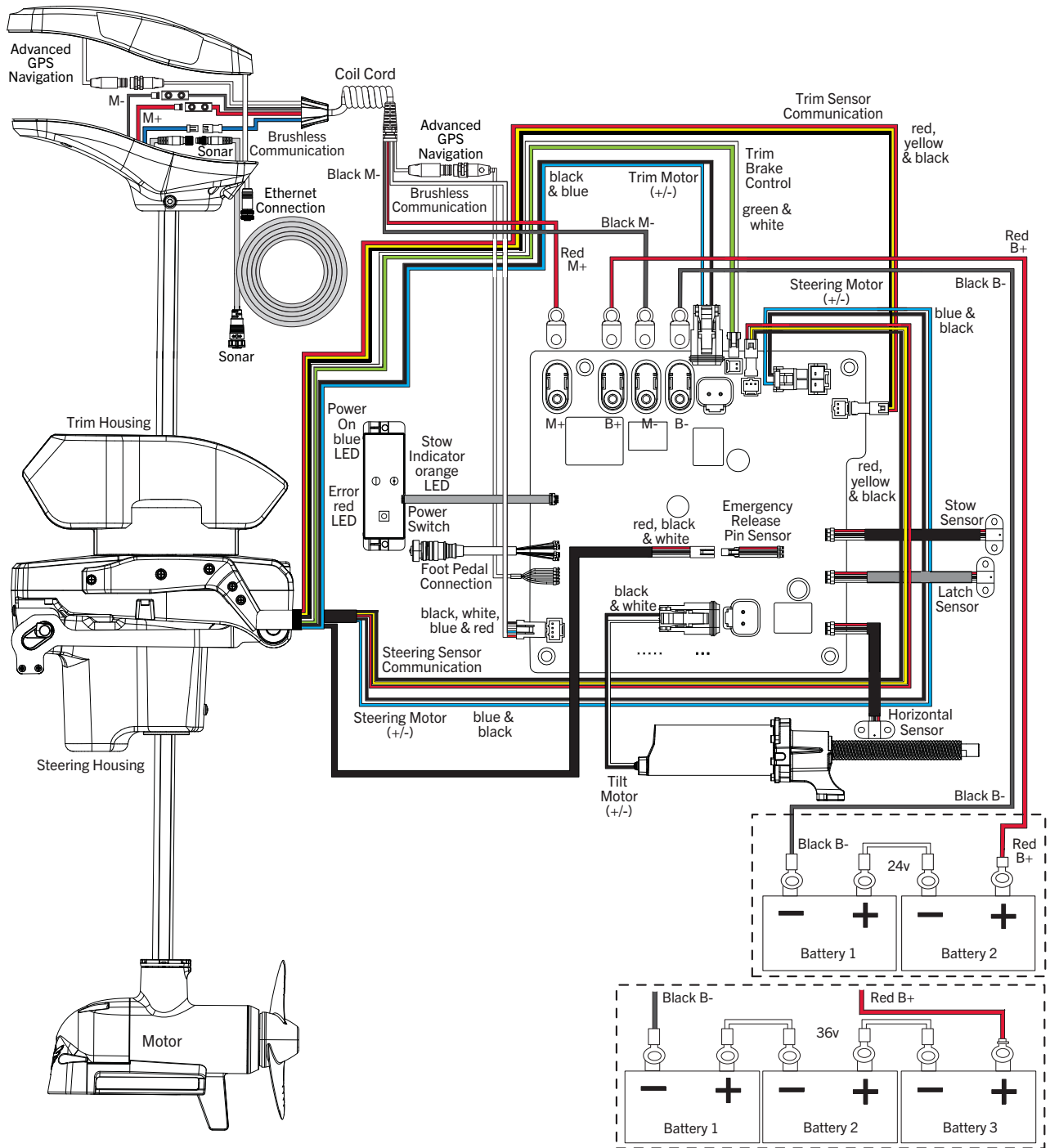

NOTICE: This is a multi-voltage diagram. Double-check your motor's voltage for proper connections. Over-Current Protection Devices are not shown in this illustration.

USING & ADJUSTING THE MOTOR

MOUNT FEATURES

Become familiar with the features of the motor to maximize the capabilities this product offers.

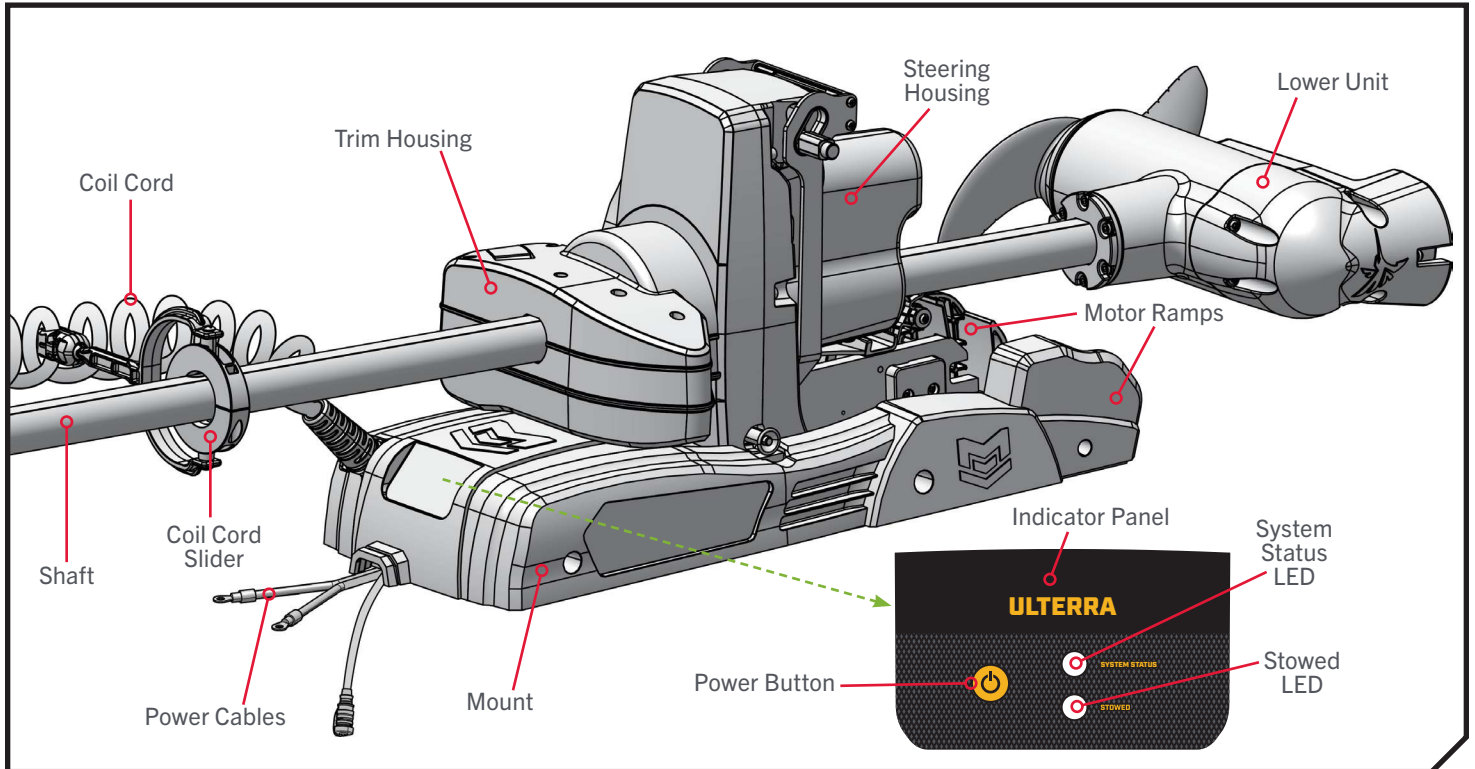

› Mount

The Mount holds the motor on the deck of the boat. The Mount positions the motor when deployed and secures the motor flat on the deck when stowed. The Indicator Panel is located on the end of the Mount, near the Power Cables.

› Motor Ramps

The Motor Ramps hold and support the Lower Unit when the motor is stowed. When the Lower Unit rests securely on the Motor Ramps, the **STOWED** LED on the Indicator Panel will illuminate orange. The Motor Ramps also hold the motor in the deployed position.



WARNING

When stowing or deploying the motor, keep fingers clear of all hinges, pivot points, pinch points and all moving parts.

› Coil Cord Slider

Motors with a shaft length of 72" have a Coil Cord Slider. The Coil Cord Slider functions to support the Coil Cord and prevent it from becoming tangled or hitting obstructions. The Coil Cord Slider sits on the Shaft between the Control Head and Trim Housing. The arm of the Coil Cord Slider connects to the Coil Cord. The Coil Cord Slider floats freely on the shaft and moves with the Coil Cord while stowing and deploying. The Coil Cord Slider is not present on motors with a shaft length of 45" or 60".

INDICATOR PANEL

⚠️ WARNING

When transporting the motor, it is important to always stow the motor and ensure the Lower Unit is securely placed on the Motor Ramps. The STOWED LED on the Indicator Panel must illuminate orange to indicate a secure stow. A secure stow holds the motor in place during transportation when it is subject to high levels of shock and vibration. Failure to securely stow the motor may result in injury or damage to the unit.

⚠️ CAUTION

Ensure that the Power button is turned off when the motor is not in use. For safety reasons, disconnect the motor from the batteries when the motor is not in use or while the batteries are charging. If the motor control is left on and the Prop rotation is blocked, severe motor damage can result.

INDICATOR PANEL

The Indicator Panel is located on the end of the Mount, by the Power Cables. Power to the motor is turned "on" and "off" through the Power button on the Indicator Panel. The LEDs on the Indicator Panel communicate the status of the motor.

› Power Button

On the Indicator Panel, press the Power button once to turn the motor "on." When the motor is powered on, the System Status LED will illuminate blue. To turn the motor "off," press and release the Power button. When the motor is powered off, the System Status LED will not be illuminated. The Ulterra QUEST has an auto-shutoff and will automatically power off after 90 minutes of inactivity in the stowed position.

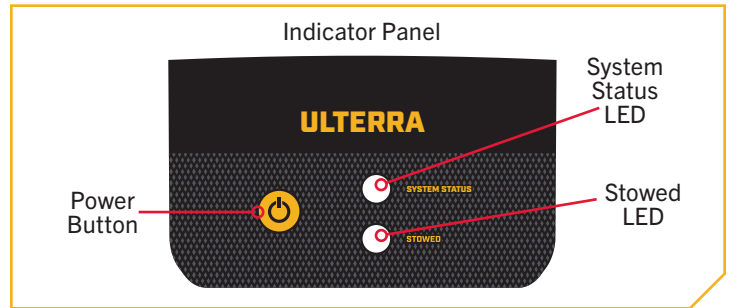

› LED Patterns

STOWED

- **Orange solid** - Indicates that the trolling motor is stowed and the Lower Unit is resting securely on the Motor Ramps. When the Lower Unit is off of the Motor Ramps, the STOWED LED will not be illuminated.

SYSTEM STATUS

- **Blue solid** - Normal operation. The trolling motor is powered on. When the Motor is powered off, the System Status LED will not be illuminated.
- **Red flashing** - Critical error. The Prop will lock and cannot be engaged. A critical error must be manually cleared by correcting the source of the error. Once fixed, cycle power to the trolling motor by pressing the Power button "off" and then back "on" to clear the error and resume normal operation.

⚠️ WARNING

The trolling motor is not safely stowed for transport until the orange STOWED LED is illuminated.

NOTICE: When encountering a critical error, the Wireless Remote will provide an error code in the Diagnostics menu. Refer to the Wireless Remote Owner's Manual to learn more about error codes.

STOWING AND DEPLOYING THE ULTERRA QUEST

STOWING AND DEPLOYING THE ULTERRA QUEST

The Ulterra® QUEST gives you push-button command from anywhere on the boat. Stow, deploy or trim the motor up and down by using the buttons on your Advanced GPS Navigation Wireless Remote, Foot Pedal, One-Boat Network app, or a connected Humminbird® fish finder. It's instant. Effortless. And it makes Ulterra QUEST the easiest-to-use motor on the water.

Use the following procedures to stow and deploy the motor. If the motor stalls when attempting to stow, the motor may be encountering an error. Check for obstructions or low motor batteries. If the batteries are too low to fully stow the motor, re-engage power, deploy the motor, trim the lower unit to its highest setting, and turn power off until batteries can be recharged. Once batteries are charged, attempt to stow the motor again.





BATTERY MONITORING



Minn Kota understands the importance of maximizing time on the water to gain a competitive edge. Minn Kota QUEST Series trolling motors provide real-time battery and runtime readings of the trolling motor battery system when connected to a compatible Humminbird fish finder. Compatible Humminbird fish finders include HELIX G3N and newer and all SOLIX and APEX models. Answer a few easy questions on the Humminbird to set the battery chemistry and system type, then let the system monitor the batteries connected to the trolling motor while the prop is running. The fish finder will display the remaining battery in 1% increments, giving essential data about the trolling motor battery system, including time remaining and time at empty - all displayed on an intuitive dashboard on the Humminbird fish finder. Please see the Humminbird fish finder Owner's Manual online at humminbird.johnsonoutdoors.com to learn more about Minn Kota Battery Monitoring.

STOW & DEPLOY >

STOWING AND DEPLOYING WITH THE WIRELESS REMOTE

> Deploying with the Wireless Remote

- 1
 - a. Press the Power  button on the Wireless Remote.
 - b. Use the Speed Up  or Speed Down  button to find Ulterra.
 - c. Press the Steer Right  button to select Ulterra and open Deployment Mode.

NOTICE: Alternatively, press the One-Boat Network  side button to quickly access Deployment Mode. The function of the OBN  side button is set by default to open the Ulterra Deployment Mode menu.

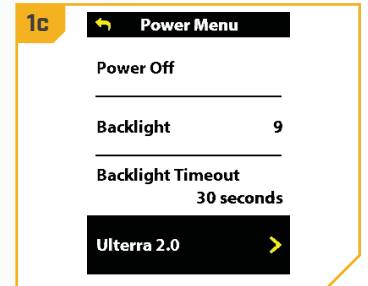
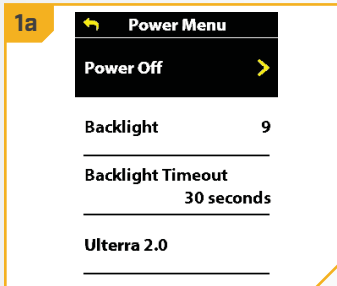

NOTICE: The Wireless Remote comes from the factory paired to the Ulterra QUEST.

STOWING WITH THE WIRELESS REMOTE

2

- d. Press the Steer Right button to select Deploy. The motor will automatically deploy.

WARNING

As soon as Deploy is selected, the motor will automatically deploy. Be sure that the motor is clear from obstructions and has a clear path of travel. The Prop is disabled while the motor is stowing or deploying to prevent accidental contact with the rotating Prop.

- e. While the Motor is deploying, it is possible to pause the action. To pause the action, press the Steer Right button to select Pause.
- f. To resume the Deploy action, press the Steer Right button to select Deploy.
- g. If the Motor continues, it will complete the deploy process and normal motor operation will follow.

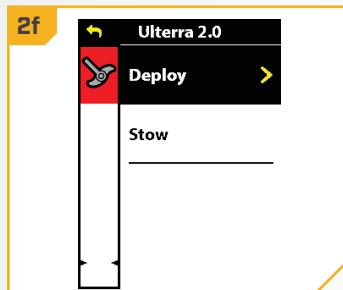
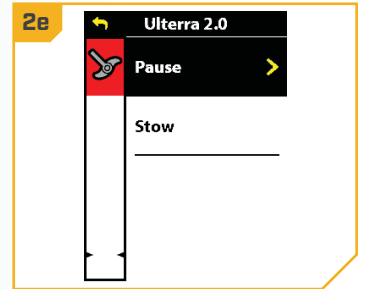
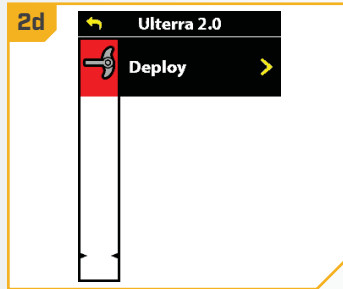

NOTICE: To avoid churning or agitation of surface water, ensure that the top of the motor is submerged at least 12" below the surface of the water.

Stowing with the Wireless Remote

1

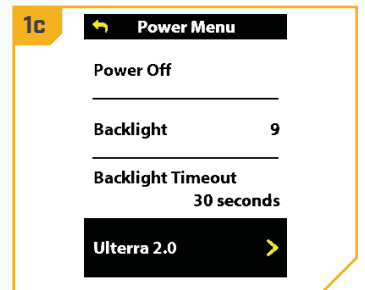
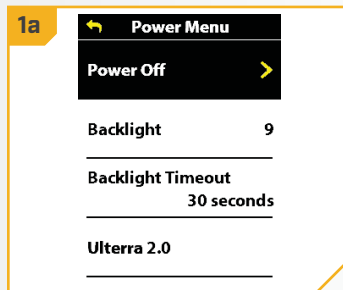

- a. Press the Power button on the Wireless Remote.
- b. Use the Speed Up or Speed Down button to find Ulterra.
- c. Press the Steer Right button to select Ulterra and open Deployment Mode.

NOTICE: Alternatively, press the One-Boat Network side button to quickly access Deployment Mode. The function of the OBN side button is set by default to open the Ulterra Deployment Mode menu.



STOWING WITH THE WIRELESS REMOTE



2

- d. Use the Speed Up  or Speed Down  button to find Stow. Use the Steer Right  button to select it. Once selected, the motor will automatically stow, and the Prop will be disabled.



WARNING

As soon as Stow is selected, the motor will automatically stow. Be sure the motor is clear from obstructions and has a clear path of travel. The Prop is disabled while the motor is stowing or deploying to prevent accidental contact with the rotating Prop.

- e. While the Motor is stowing, it is possible to pause the action. To pause the action, press the Speed Down  button to find Pause and press the Steer Right  button to select it.
- f. To resume the Stow action, press the Steer Right  button to select Stow.
- g. If the Motor continues, it will complete the Stow process and normal motor operation will follow.

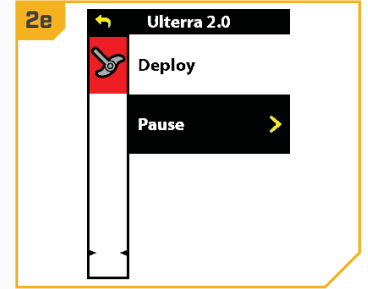
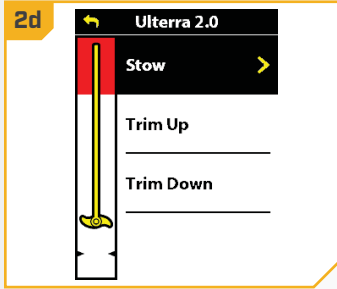

NOTICE: The Stow option is only displayed when the motor is deployed.



WARNING

The motor is not safely stowed for transport until the orange STOWED  LED on the Indicator Panel is illuminated.

DEPLOYING WITH THE OBN APP

STOWING AND DEPLOYING WITH THE ONE-BOAT NETWORK (OBN) APP

Deploying with the OBN App

- 1 a. Open the One-Boat Network (OBN) app on the mobile device. Make sure the mobile device is paired with the trolling motor.
- b. From the OBN home screen, tap the Motor menu. The Motor menu opens the Motor home screen.
- c. Before the Motor home screen will open, tap Agree on the on-screen prompt.

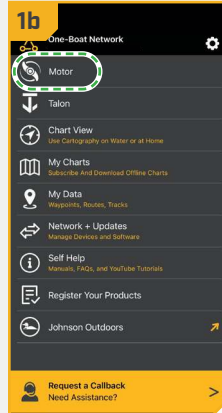

NOTICE: The on-screen prompt will only display once each time the app is launched. If the prompt has displayed, the Motor home screen appears after.

- 2 d. Tap Trim/Stow on the bottom of the screen to open the Trim/Stow/Deploy menu.
- e. Tap Deploy to automatically deploy the motor. Normal motor operation will follow.

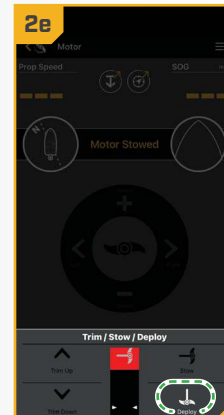

WARNING

As soon as Deploy is tapped, the motor will automatically deploy. Be sure that the motor is clear from obstructions and has a clear path of travel. The Prop is disabled while the motor is stowing or deploying to prevent accidental contact with the rotating Prop.

NOTICE: While the motor is deploying, it is possible to stop the action by tapping Pause. To resume, tap the desired action.

NOTICE: To avoid churning or agitation of surface water, ensure that the top of the motor is submerged at least 12" below the surface of the water.

› Stowing with the OBN App

1

- a. Open the One-Boat Network (OBN) app on the mobile device. Make sure the mobile device is paired with the trolling motor.
- b. From the OBN home screen, tap the Motor menu. The Motor menu opens the Motor home screen.
- c. Before the Motor home screen will open, tap Agree on the on-screen prompt.

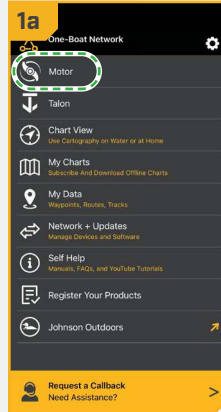

NOTICE: The on-screen prompt will only display once each time the app is launched. If the prompt has displayed, the Motor home screen appears after.

2

- d. Tap Trim/Stow on the bottom of the screen to open the Trim/Stow/Deploy menu.
- e. Tap Stow to automatically stow the motor. The Prop will be disabled and "Motor Stowed" will display on the screen.



WARNING

As soon as Stow is tapped, the motor will automatically stow. Be sure the motor is clear from obstructions and has a clear path of travel. The Prop is disabled while the motor is stowing or deploying to prevent accidental contact with the rotating Prop.

NOTICE: While the motor is stowing, it is possible to stop the action by tapping Pause. To resume, tap the desired action.

WARNING

The motor is not safely stowed for transport until the orange STOWED LED on the Indicator Panel is illuminated.

STOWING AND DEPLOYING WITH THE FOOT PEDAL

STOWING AND DEPLOYING WITH THE FOOT PEDAL

1

- a. On the Foot Pedal, press the MODE button so that the white MODE MODE LED on the Indicator Panel is illuminated, putting the Foot Pedal in Deployment Mode.

NOTICE: The motor can only stow and deploy in Deployment Mode.

- b. To deploy the motor when it is stowed, double press the Stow/Deploy button. To stow the motor when it is deployed, single press the Stow/Deploy button.

WARNING

When stowing or deploying the motor, keep fingers clear of all hinges, pivot points, and all moving parts. When stowing and deploying the motor, ensure that it doesn't contact the boat, trailer, or any other obstruction.

NOTICE: The **deploy** sequence can be stopped anytime by pressing the Stow/Deploy button. The **stow** sequence can be stopped at any time by pressing either the Trim Up or Trim Down button or the Stow/Deploy button.

NOTICE: To avoid churning or agitation of surface water, ensure that the top of the motor is submerged at least 12" below the surface of the water.

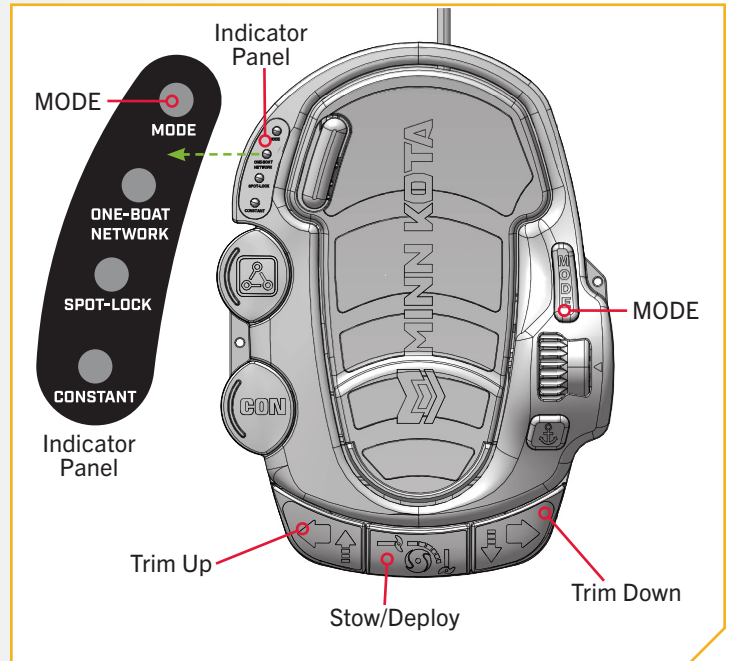

WARNING

The motor is not safely stowed for transport until the orange STOWED STOWED LED on the Indicator Panel is illuminated.

ADJUSTING THE DEPTH (TRIM) OF THE ULTERRA QUEST





ADJUSTING THE DEPTH (TRIM) OF THE ULTERRA QUEST

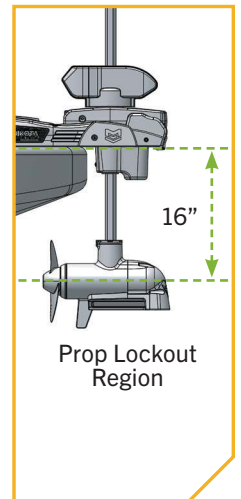
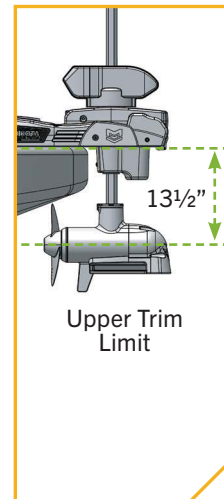
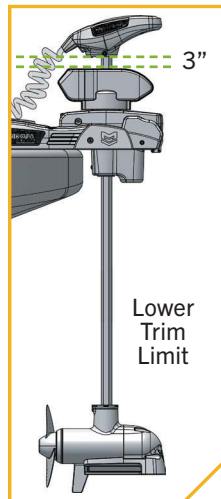
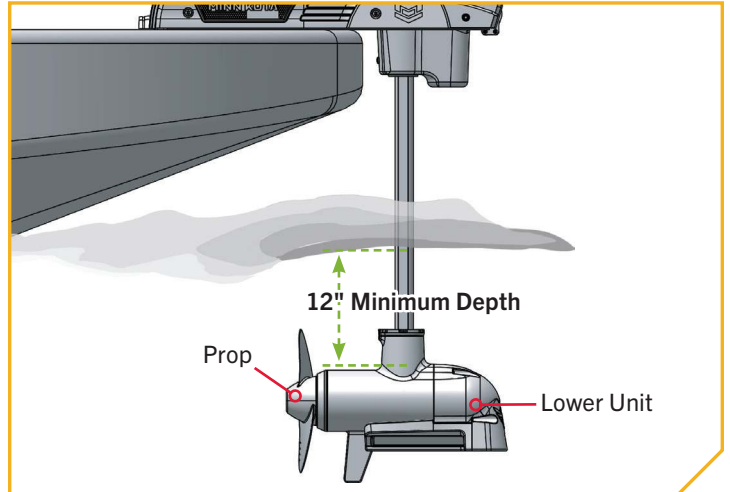

Once the boat is on the water, it may be necessary to adjust the trim of the Lower Unit up or down to achieve an optimum depth for motor performance. When setting the depth of the motor, be sure the top of the Lower Unit is submerged at least 12" below the surface of the water to avoid churning or agitation of surface water. It may be necessary to trim the motor up or down, depending on how the boat is responding. Trim up to avoid hitting underwater objects and trim down if the Prop is coming out of the water.

The Prop will temporarily stop while trimming the motor and resume once trimming is stopped. The motor is programmed to operate safely and limit Prop rotation when the Lower Unit is trimmed within certain limits. Trim limits are in place to avoid damage to the unit. A Lower Trim Limit is set approximately 3" from the bottom of the Control Head to the top of the Trim Housing. An Upper Trim Limit is set 13½" from the bottom of the Mount to the center of the Lower Unit. A Prop Lockout Region, defined as 16" from the bottom of the Mount to the center of the Lower Unit, is used to eliminate the possibility of the motor contacting the boat hull. All functions, except for manual steering and recording an iTrack, are canceled upon trimming into this region.



▶ Trimming with the Wireless Remote

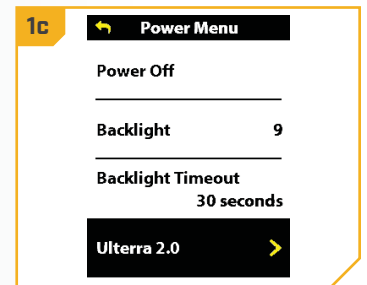
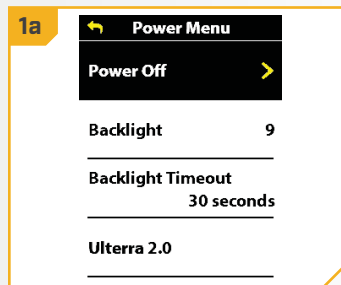

- 1 a. Press the Power  button on the Wireless Remote.
- b. Use the Speed Up  or Speed Down  button to find Ultrerra.
- c. Press the Steer Right  button to select Ultrerra and open Deployment Mode.

NOTICE: Alternatively, press the One-Boat Network  side button to quickly access Deployment Mode. The function of the OBN  side button is set by default to open the Ultrerra Deployment Mode menu.



TRIMMING WITH THE WIRELESS REMOTE

2

- d. Once in Ulterra Menu, use the Speed Up  or Speed Down  button to select Trim Up or Trim Down. Trimming up will raise the motor and trimming down will lower the motor.
- e. Press and hold the Steer Right  button to select it.
- f. When the motor has reached its highest trim limit, the Prop will be locked out and the Trim Up option will be disabled. The Prop will stay locked out even when the Deployment Menu has closed. Trim the motor down and out of the Prop Lockout region to restore functionality.
- g. When the lower trim limit is reached, the Trim Down option will be disabled.

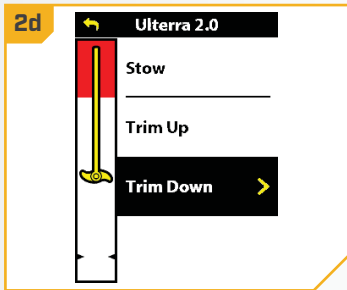
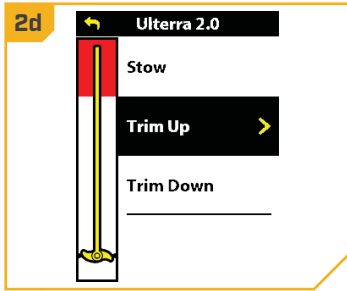
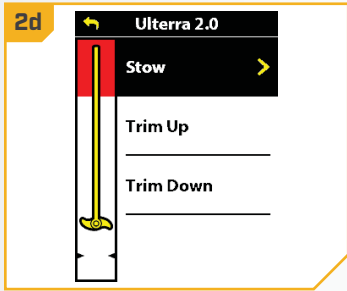

WARNING

While Trim Up or Trim Down is pressed, the motor will automatically trim. Be sure the motor is clear from obstructions and has a clear path of travel. The Prop is disabled while the motor is being trimmed to prevent accidental contact with the rotating Prop.

WARNING

When trimming the motor, keep fingers clear of all hinges, pivot points and all moving parts.

NOTICE: To avoid churning or agitation of surface water, ensure that the top of the motor is submerged at least 12" below the surface of the water.

NOTICE: The red area is the Prop Lockout region. The Prop will be automatically disabled if the lower unit is trimmed into this zone, and the Prop icon will turn gray. To restore Prop functionality, trim the lower unit out of the Prop Lockout region.

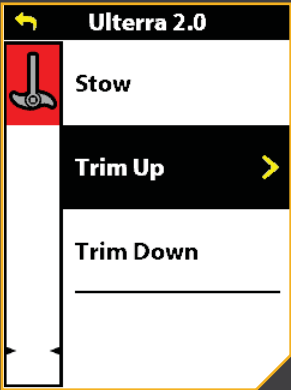

▶ Trimming with the OBN App

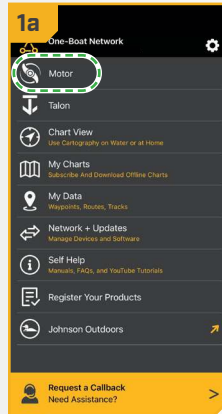

1

- a. Open the One-Boat Network (OBN) app on the mobile device. Make sure the mobile device is paired with the trolling motor.
- b. From the OBN home screen, tap the Motor menu. The Motor menu opens the Motor home screen.
- c. Before the Motor home screen will open, tap Agree on the on-screen prompt.



NOTICE: The on-screen prompt will only display once each time the app is launched. If the prompt has displayed, the Motor home screen appears after.

2

- d. Tap Trim/Stow on the bottom of the screen to open the Trim/Stow/Deploy menu.
- e. To trim the motor up, press and hold Trim Up . Continue to hold until the lower unit is at the desired height.
- f. To trim the motor down, press and hold Trim Down . Continue to hold until the lower unit is at the desired height.



WARNING

While Trim Up or Trim Down is pressed, the motor will automatically trim. Be sure the motor is clear from obstructions and has a clear path of travel. The Prop is disabled while the motor is being trimmed to prevent accidental contact with the rotating Prop.

WARNING

When trimming the motor, keep fingers clear of all hinges, pivot points and all moving parts.

NOTICE: To avoid churning or agitation of surface water, ensure that the top of the motor is submerged at least 12" below the surface of the water.

NOTICE: The red area is the Prop Lockout region. The Prop will be automatically disabled if the lower unit is trimmed into this zone, and the Prop icon will turn gray. To restore Prop functionality, trim the lower unit out of the Prop Lockout region.



TRIMMING WITH THE FOOT PEDAL

Trimming with the Foot Pedal

1

- a. On the Foot Pedal, press the MODE button so that the white MODE MODE LED on the Indicator Panel is illuminated, putting the Foot Pedal in Deployment Mode.

NOTICE: The motor can only trim while in Deployment Mode.

WARNING

When trimming the motor, keep fingers clear of all hinges, pivot points, and all moving parts.

WARNING

While Trim Up or Trim Down is pressed, the motor will automatically trim. Be sure the motor is clear from obstructions and has a clear path of travel. The Prop is disabled while the motor is being trimmed to prevent accidental contact with the rotating Prop.

- b. To trim the motor up, press the Trim Up button located on the bottom left of the Foot Pedal.
- c. To trim the motor down, press the Trim Down button located on the bottom right of the Foot Pedal.

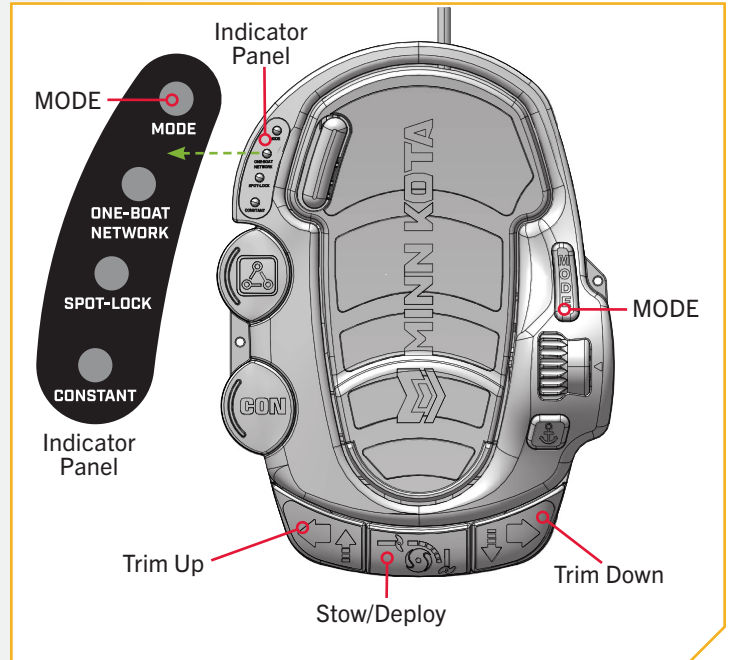

NOTICE: To avoid churning or agitation of surface water, ensure that the top of the motor is submerged at least 12" below the surface of the water.

MOTOR ADJUSTMENTS >

> Adjusting the Lift Belt

The Lift Belt assists in trimming the Lower Unit up and down. Slack may appear periodically in the Lift Belt along the Shaft of the motor. To maintain tension on the Lift Belt, the screw that holds tension on the Lift Belt may occasionally require small adjustments.

1

- a. Place the motor in the stowed position. Once stowed, turn the motor off.



WARNING

Disconnect the motor from power to avoid accidental operation.

- b. Locate the Socket Head Cap Screw on the bottom of the Control Head, between the Coil Cord and Shaft. Adjust this Screw to increase tension on the Lift Belt.
- c. Using a 5/32" Allen Wrench, turn the Socket Head Cap Screw clockwise to tighten the Lift Belt. Tighten to 8–10 in-lb.

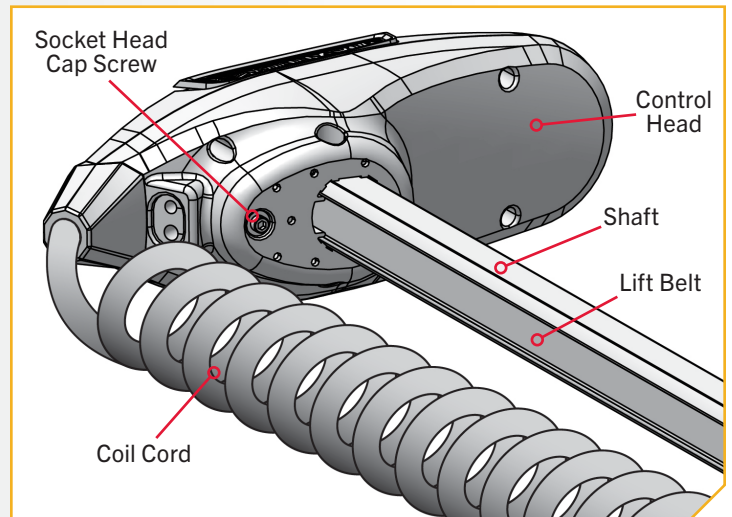

MOTOR ADJUSTMENTS

› Greasing the Tilt Shaft and Latch Pin

To maintain optimum performance of the Ulterra QUEST, it is recommended that the Tilt Shaft and Latch Pin be greased every season. Minn Kota recommends using a marine-grade grease.

- 1** a. Deploy the motor. Once deployed, turn the motor off.

WARNING

Disconnect the motor from power to avoid accidental operation.

- b. Locate the Tilt Shaft near the center of the Mount, in the space between the Mount and Steering Housing.
- c. Apply a marine-grade grease to the exposed threads of the Tilt Shaft. Apply the grease sparingly.

NOTICE: Ensure that the space between the Mount and Steering Housing is clean and free of debris. The Mount has a Stow Pad that contacts the Steering Housing when stowed. The motor cannot stow securely if an obstruction is present on the Stow Pad.

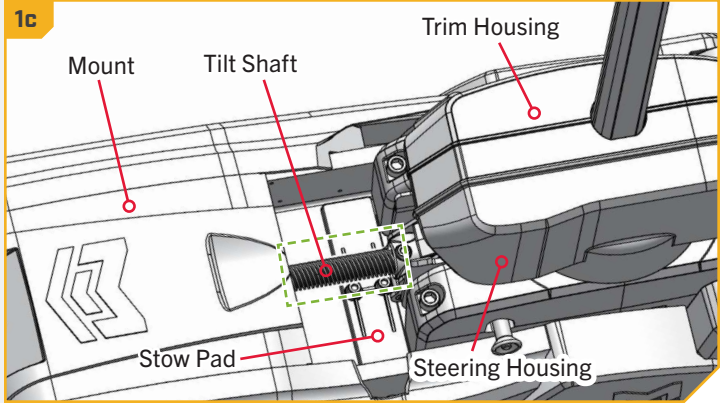

CAUTION

When stowing and deploying the motor, keep fingers clear of all hinges, pivot points and all moving parts.

- 2** d. Reconnect power to the motor. Turn the motor “on.”
- e. Stow the motor. Once stowed, turn the motor off.

WARNING

Disconnect the motor from power to avoid accidental operation.

- f. Locate the Latch Pin at the bottom of the Steering Housing. The Latch Pin is part of the Latch Bracket Handle.
- g. Apply marine-grade grease to both ends of the Latch Pin to maintain optimal performance. Apply the grease sparingly to both ends of the Latch Pin where the Latch Pin contacts the Latch Bracket Handle.

CAUTION

Do not engage the Latch Bracket Handle while greasing the Latch Pin to avoid pinch points.

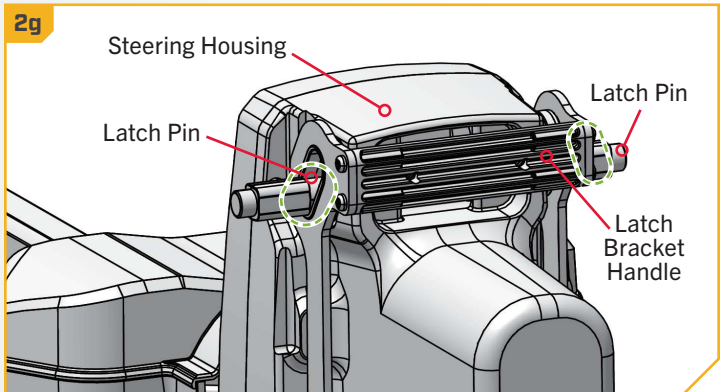

CAUTION

When stowing and deploying the motor, keep fingers clear of all hinges, pivot points and all moving parts.

› Installing an External Transducer

An external transducer is not included with your trolling motor. An external transducer can be installed onto motors that have Advanced GPS Navigation. Installing an external transducer is not recommended for motors with Built-in MEGA Side Imaging.

1

- a. Mount the External Transducer according to directions provided with the transducer.
- b. Leave enough slack in the Transducer Cable between the Lower Unit and Control Head to allow the motor to properly stow and deploy.
- c. Use two tie wrap cables to secure the Transducer Cable to the Shaft just above the Lower Unit and just below the Control Head.
- d. Run the Transducer Cable through the Coil Cord to the power supply.

CAUTION

Failure to follow the recommended wire routing for the Sonar and External Transducer Cables may cause damage to the product and void your product warranty. Take care to test the length and placement of all cables to ensure that there is enough slack where needed and that cables are free of entanglement by moving parts. Routing the cables in any way other than as directed may cause damage to the cables via pinching or severing.

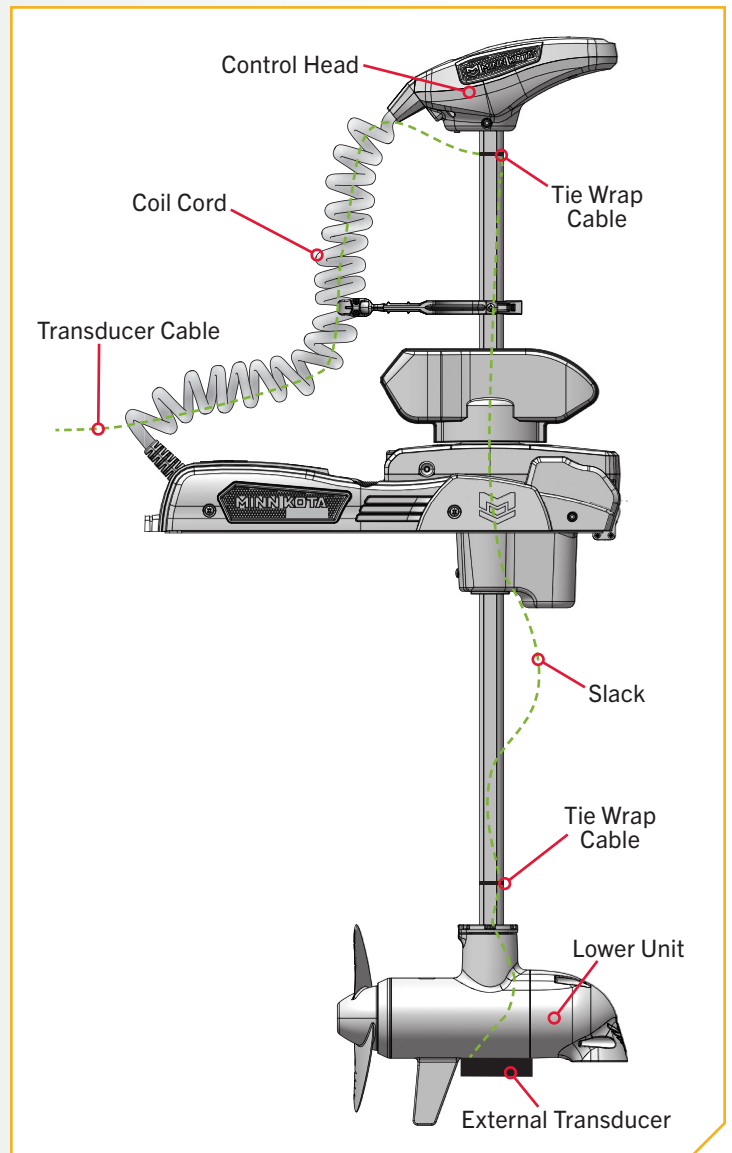

EMERGENCY STOW PROCEDURES

EMERGENCY STOW PROCEDURES >

In the unlikely event that the motor will not stow from the Wireless Remote, One-Boat Network app, or Foot Pedal, the following alternative stow methods can be used to resolve the issue.

NOTICE: If the motor stalls when attempting to stow, the motor may be encountering an error. Check for obstructions or low motor batteries. If the batteries are too low to fully stow the motor, re-engage power, deploy the motor, trim the lower unit to its highest setting, and turn power off until batteries can be recharged. Once batteries are charged, attempt to stow the motor again.



> Stowing from the Mount

In the unlikely event the Wireless Remote, One-Boat Network app, or Foot Pedal becomes non-functioning, the motor can be stowed from the Indicator Panel at the base of the Mount.

1

WARNING

During this procedure, the motor will go into an automated sequence. Keep fingers clear of all hinges, pivot points and all moving parts. Ensure that the motor or parts of the motor do not contact the boat, trailer, persons, or any other obstruction.

- Locate the Indicator Panel at the base of the Mount.
- Ensure that the motor is powered “on” by checking that the System Status  LED is illuminated blue.
- Press and hold the Power  button for 10 seconds.
- The blue and orange LEDs next to the System Status (blue) and Stowed (orange) Indicators will flash alternately, and the motor will begin to stow.

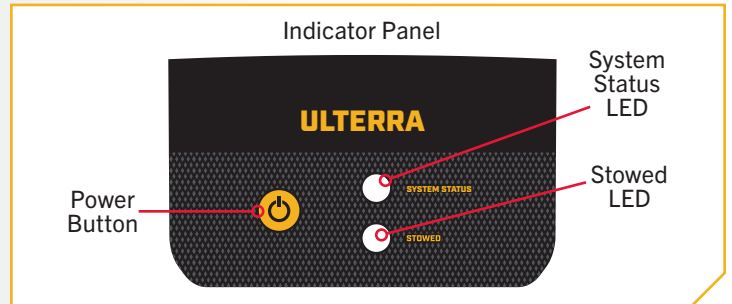

MANUAL STOW BYPASS

If the motor loses power or will not stow by any other method, a Manual Stow Bypass procedure can be used to manually stow the motor. The Manual Stow Bypass involves two steps:

- Manually Trim the Motor
- Manually Stow the Motor

After completing both steps of the Manual Stow Bypass, return to shore and resolve the error or take the motor to a Minn Kota authorized service provider. Once the error has been resolved, see the “Manual Stow Bypass Recovery” section for instructions on restoring motor functions after an emergency stow.



Scan to find additional help.

WARNING

While servicing the motor, stay clear of pinch points and do not wear loose-fitting clothing or loose-fitting jewelry.

CAUTION

Once the motor has been manually stowed, it will be non-operational until it is manually recovered.

NOTICE: In the event of a Manual Stow Bypass, the Quick Release Pin is removed from the Steering Housing. To reinstall the Quick Release Pin and restore motor functions, the Steering Housing must be in the same position it was in when the Quick Release Pin was removed. Incorrect installation of the Quick Release Pin may cause severe damage to the motor. See the “Manual Stow Bypass Recovery” section for more information.

› Manually Trim the Motor

1

WARNING

Disconnect the motor from power to avoid accidental operation.

- a. With the motor deployed, locate the Trim Release Lever on the side of the Trim Housing.
- b. Firmly grasp the Shaft of the motor. While lifting up on the Shaft, open the Trim Release Lever.
- c. Manually trim the motor by pulling the Shaft upward. Stop lifting when there are approximately 10 inches of Shaft remaining below the Steering Housing.
- d. Rotate the Shaft so that the Prop faces Port. The Lower Unit should be perpendicular to the Mount.
- e. Close the Trim Release Lever to secure the Shaft in place.

WARNING

Moving parts can cut or crush. When using the Trim Release Lever or moving the Shaft, keep fingers clear of all hinges, pivot points, and moving parts. Take care when mechanical parts are in motion.

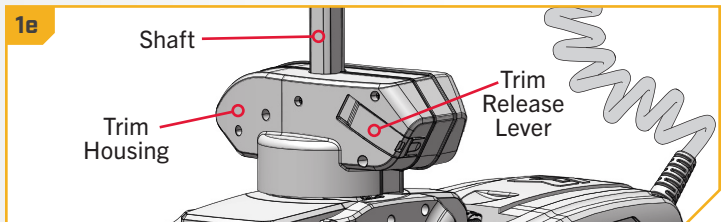
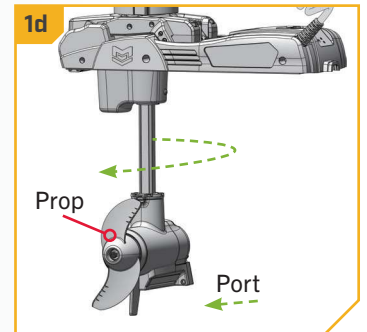
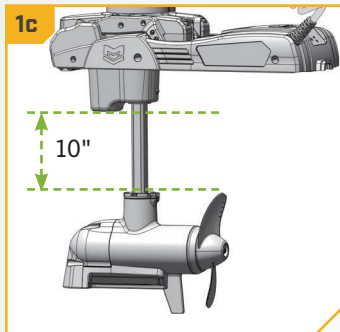
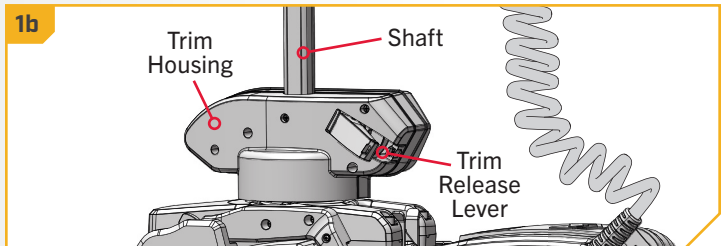

MANUAL STOW BYPASS

Manually Stow the Motor

1

NOTICE: Complete the Manual Trim before beginning this procedure.

- a. Locate the Quick Release Lever on the Steering Housing, above the Tilt Shaft near the center of the Mount. Open the Quick Release Lever by lifting upward.
- b. Locate the Quick Release Pin on the side of the Steering Housing. Push in the center of the Pin. While keeping the center of the Pin pushed in, pull the Pin completely out of the Steering Housing.

NOTICE: Do not lose the Quick Release Pin. The Motor cannot function without the Quick Release Pin.

- c. Locate the Latch Bracket Handle on the back of the Steering Housing, near the Motor Ramps.
- d. Firmly grasp the Shaft and raise the Latch Bracket Handle. While holding both the Shaft and Latch Bracket Handle, pivot the trolling motor into the stowed position.

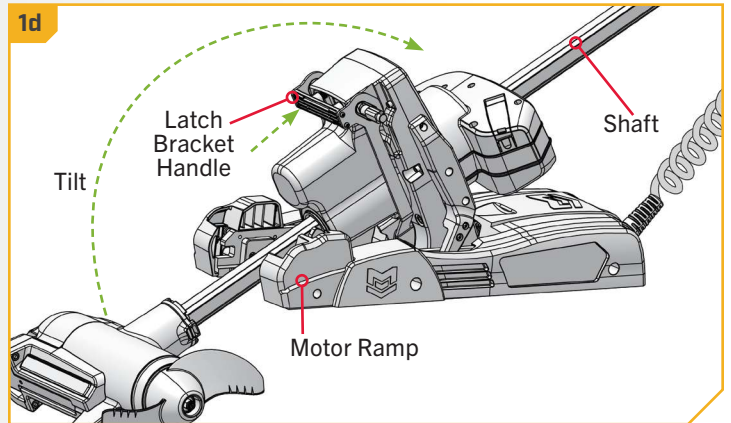
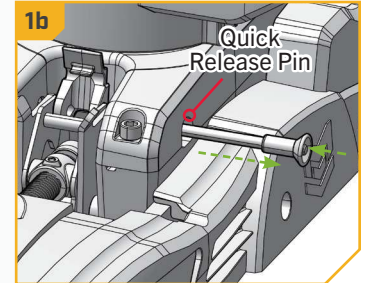
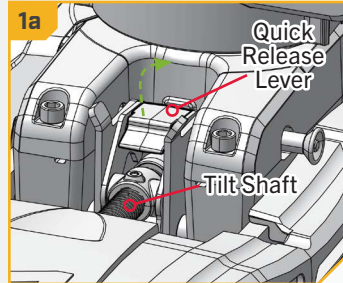

2

- e. With the motor in the stowed position, release the Latch Bracket Handle while maintaining a hold on the Shaft.
- f. Locate the Trim Release Lever on the side of the Trim Housing. While holding the Shaft, open the Trim Release Lever.
- g. Pull the Lower Unit fully onto the Motor Ramps. Secure the lower unit on the Motor Ramps and close the Trim Release Lever to lock the motor in the stowed position.

NOTICE: Once on shore, take the motor to an Authorized Service Provider or use the Minn Kota Help Center at minnkota.johnsonoutdoors.com.

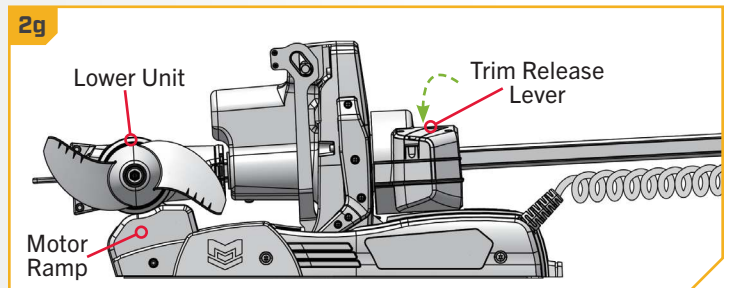
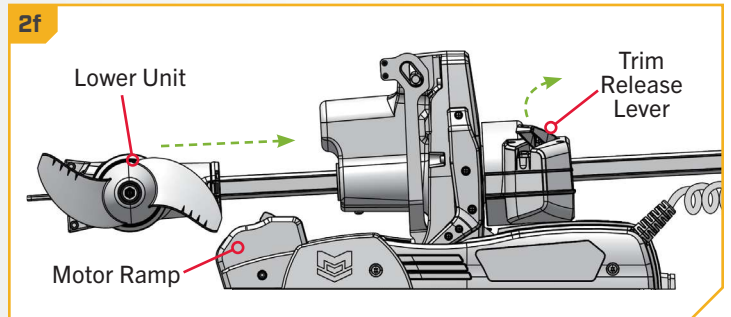

MANUAL STOW BYPASS RECOVERY

MANUAL STOW BYPASS RECOVERY

After completing a Manual Stow Bypass, most motor functions are disabled, and an error will display on the Wireless Remote. If the error that required an emergency stow is resolved, motor operation can be restored through a Manual Stow Bypass Recovery procedure. To recover from a Manual Stow Bypass, the motor must be manually deployed and the Quick Release Pin reinstalled.

CAUTION

Once the motor has been manually stowed, it will be non-operational until the Manual Stow Bypass is recovered.

1

WARNING

Disconnect the motor from power to avoid accidental operation.

- a. With the motor powered “off” and in the stowed position, locate the Trim Release Lever on the side of the Trim Housing. Firmly grasp the Shaft and open the Trim Release Lever.
- b. While holding the Shaft, slide the Lower Unit approximately 10 inches Outboard. Keep the Shaft horizontal to prevent the motor from tilting. When the Lower Unit is clear of the Motor Ramps, close the Trim Release Lever to lock the Shaft.
- c. While holding the Shaft and Steering Housing, pivot the motor into the deployed position. Guide the motor upright until the Latch Pin fully engages with the Motor Ramps.

WARNING

Moving parts can cut or crush. Keep fingers clear of all hinges, pivot points, and moving parts when using the Trim Release Lever, moving the Shaft, or tilting the motor. Take care when mechanical parts are in motion.

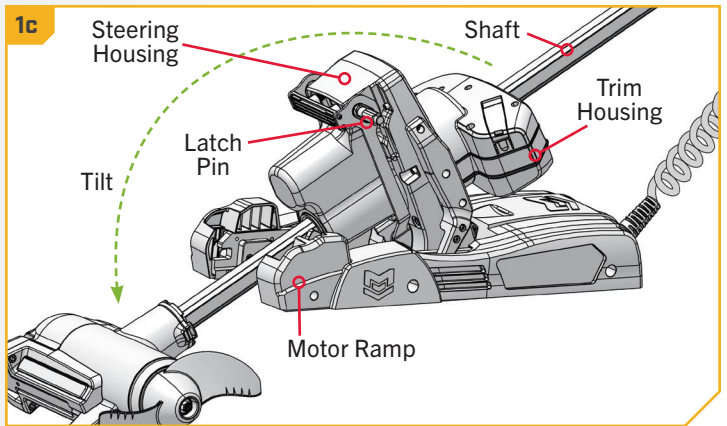
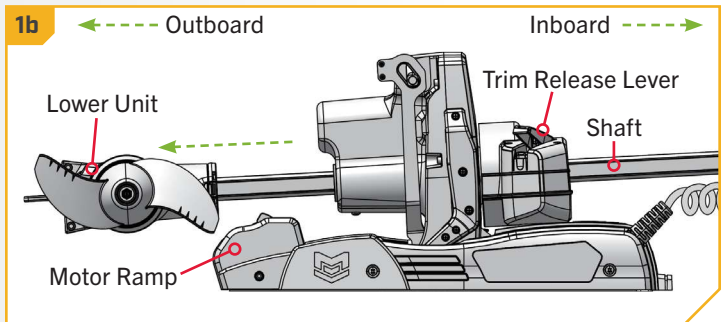

MANUAL STOW BYPASS RECOVERY

2

- d. Take the Quick Release Pin that was removed during the Manual Stow Bypass.
- e. Locate the hole for the Quick Release Pin on the Port side of the Steering Housing.
- f. The Quick Release Pin must pass through four center plates between the Steering Housing to properly install. If the holes in the plates are not aligned, pull the Quick Release Lever to lift the plates. Realign the plates as needed to allow the Quick Release Pin to be completely inserted.
- g. Press and hold in the center of the Quick Release Pin. While pressing the center of the Pin, insert the Quick Release Pin into the Steering Housing. Ensure that the Quick Release Pin passes through all four plates and into the other side of the Steering Housing. The Quick Release Pin is fully inserted when the handle is seated against the Steering Housing. The retaining ball in the Quick Release Pin must be visible past the final plate.

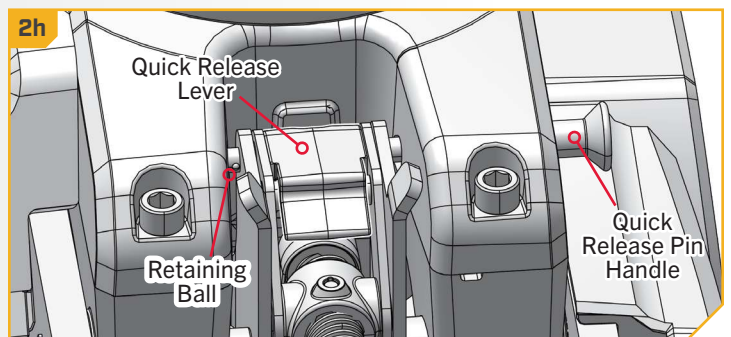
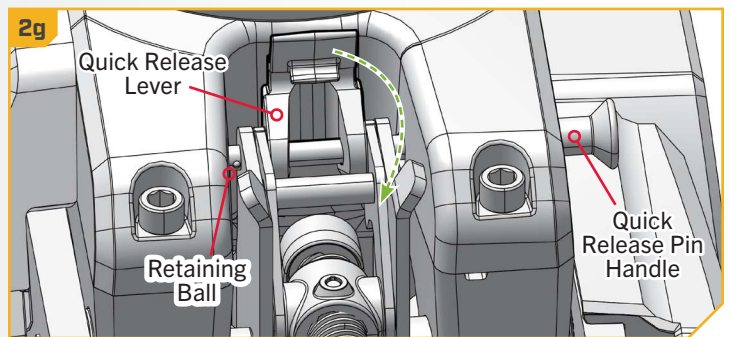
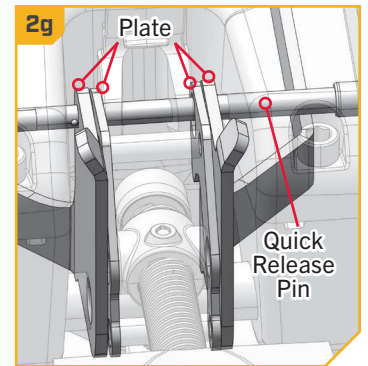
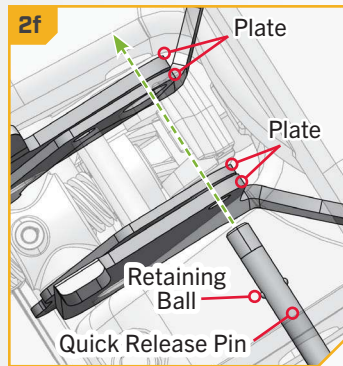
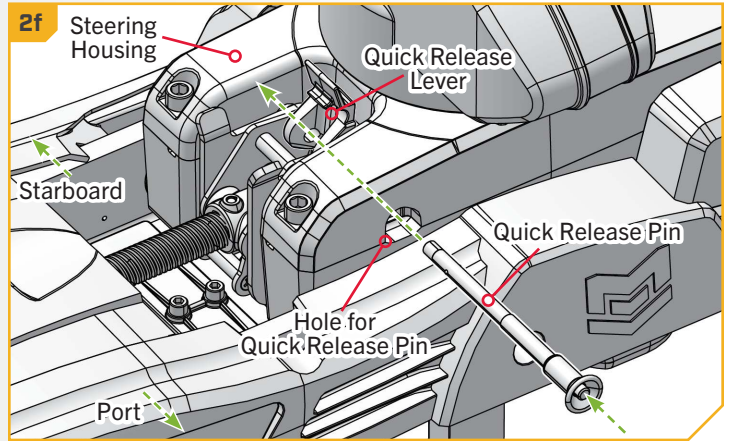

NOTICE: If the Quick Release Pin is installed incorrectly and does not capture all four plates, severe motor damage may occur.

- h. With the Quick Release Pin fully inserted, lower the Quick Release Lever. Ensure the Lever is seated.

⚠ CAUTION

Watch for pinch points when closing the Quick Release Lever. Push on the back of the Quick Release Lever with an open palm to keep fingers clear of pinch points.

- i. Reconnect the motor to power. Normal motor operation may resume.

NOTICE: The Quick Release Pin must be fully inserted for the motor to function.

NOTICE: If the motor is nonfunctional after restoring power and reinstalling the Quick Release Pin, contact a Minn Kota authorized service provider.

USING THE FOOT PEDAL

CONTROLLING SPEED & STEERING WITH THE FOOT PEDAL

The Foot Pedal is used to operate the Ulterra QUEST trolling motor. The controls on the Foot Pedal are easy to use. The motor can also be controlled with the Advanced GPS Navigation Wireless Remote or One-Boat Network app. Refer to the associated accessory manual for instructions.

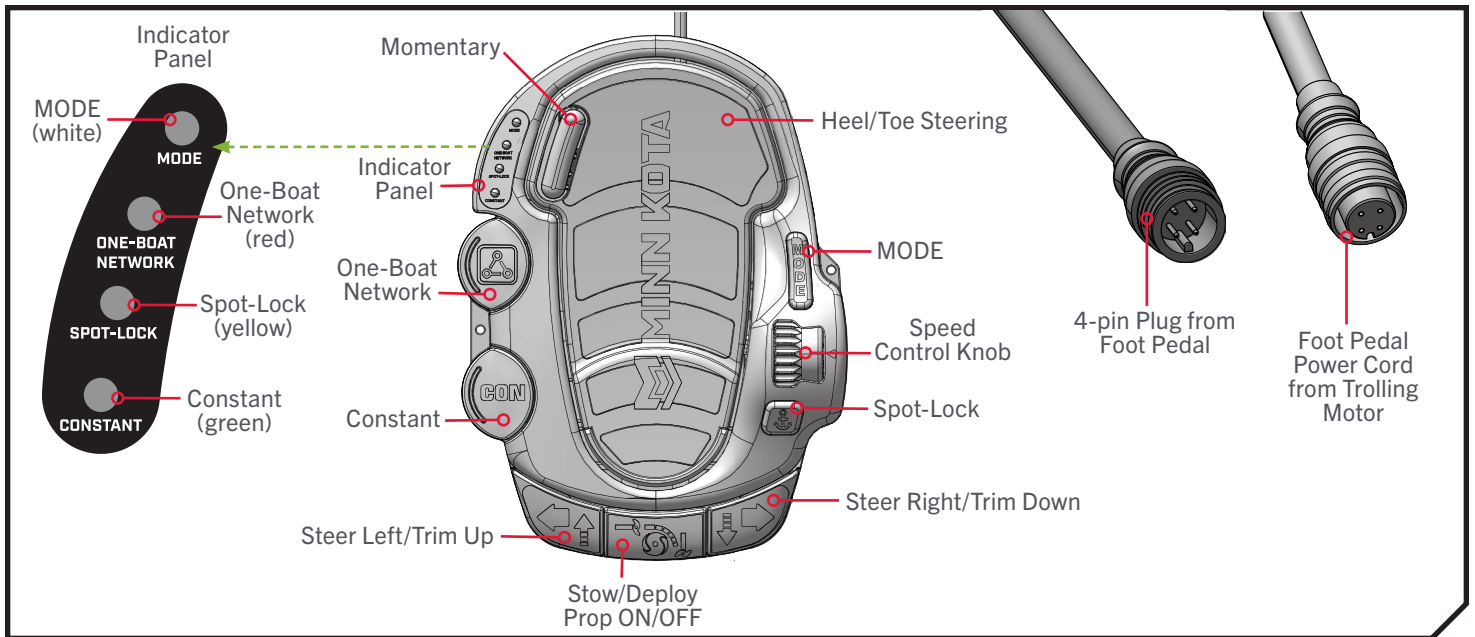

MODES

The Foot Pedal has two modes of operation: Normal Mode and Deployment Mode. To alternate between the Modes, press the MODE button located on the right side of the Foot Pedal, just above the Speed Control Knob. The MODE LED on the Indicator Panel illuminates white when Deployment Mode is engaged. Switching between Modes alters the functions of the three buttons at the bottom of the Foot Pedal. These buttons include:

Button Location	Normal Mode	Deployment Mode
Left	Steer Left	Trim Up
Center	Prop ON/OFF	Stow/Deploy
Right	Steer Right	Trim Down



WARNING

Practice proper ergonomics when operating the foot pedal to prevent injury.

› Normal Mode

When in Normal Mode, the buttons at the bottom of the Foot Pedal function to Steer Left, Steer Right, and turn the Prop ON/OFF. The white MODE LED on the Indicator Panel will not be illuminated when in Normal Mode.

› Deployment Mode

When in Deployment Mode, the buttons at the bottom of the Foot Pedal function to Trim Up, Trim Down, and Stow/Deploy. The white MODE LED on the Indicator Panel will be illuminated during Deployment Mode.

FOOT PEDAL OPERATION



WARNING

You are responsible for the safe and prudent operation of your vessel. We have designed the Foot Pedal to be an accurate and reliable tool that will enhance boat operation and improve your ability to catch fish. This product does not relieve you from the responsibility for the safe operation of your boat. You must avoid hazards to navigation and always maintain a permanent watch so you can respond to situations as they develop. You must always be prepared to regain manual control of your boat. Learn to operate your Foot Pedal and trolling motor in an area free from hazards and obstacles.

FOOT PEDAL OPERATION



› Motor Speed

The Speed Control Knob is located between the MODE and Spot-Lock buttons on the right side of the Foot Pedal. Turn the Speed Control Knob forward to increase speed and backward to decrease speed. The Speed Control Knob can be set in a range from 0 to 10 and can be adjusted in both Normal and Deployment Modes. Speed can also be adjusted using the Wireless Remote or One-Boat Network app.



› Heel/Toe Steering

Push the Toe End of the Foot Pedal down to turn right and push the Heel End down to turn left. The position and direction of the Control Head directly corresponds to the position of the motor. Use a foot on the Foot Pedal to control the steering direction during manual operation. Heel/Toe Steering functions the same in Normal Mode and Deployment Mode. The direction of the trolling motor can also be controlled with the Wireless Remote or One-Boat Network app.

› Steer Right/Steer Left

The Steer Right  and Steer Left  buttons are located at the bottom of the Foot Pedal. They function to steer the trolling motor to the right and left when the Foot Pedal is operating in Normal Mode. The white MODE  LED on the Indicator Panel will not be illuminated when in Normal Mode. Holding the Steer Right or Steer Left buttons down will continue to steer the motor to the left or right. Small steering changes of less than one degree can be made by quickly tapping the Steer Right and Steer Left buttons.



› Trim Down/Trim Up

The Trim Down  and Trim Up  buttons are located at the bottom of the Foot Pedal. They function to trim the motor up and down when the Foot Pedal is in Deployment Mode. The white MODE  LED on the Indicator Panel will be illuminated during Deployment Mode. The Trim Down button trims the motor down and the Trim Up button trims the motor up.



WARNING

When trimming the motor, keep fingers clear of all hinges, pivot points, and all moving parts. When stowing and deploying the motor, ensure that it doesn't contact the boat, trailer, or any other obstruction.

› Prop ON/OFF

The Prop ON/OFF  button is located at the bottom of the Foot Pedal. It functions to momentarily turn the Prop on and off when the Foot Pedal is operating in Normal Mode. The white MODE  LED on the Indicator Panel will not be illuminated when in Normal Mode. The Prop will turn on when pressure is applied to the button and turn off when pressure is removed. The Prop button does not change the behavior of the Prop when the Constant button is engaged.

› Stow/Deploy

The Stow/Deploy  button is located at the bottom of the Foot Pedal. It functions to stow and deploy the motor when the Foot Pedal is operating in Deployment Mode. The white MODE  LED on the Indicator Panel will illuminate when in Deployment Mode. When the motor is deployed, press the Stow/Deploy button to stow it. When the motor is stowed, double-press the Stow/Deploy to deploy it. When stowing and deploying the motor, the operational function of the Foot Pedal or paired remote is automatically disabled. The Prop is also disabled when the motor is stowing or deploying.



WARNING



When stowing or deploying the motor, keep fingers clear of all hinges, pivot points and all moving parts. When stowing and deploying the motor, ensure that it doesn't contact the boat, trailer, or any other obstruction.



WARNING

When transporting the motor, it is important to always stow the motor and make sure it is secured in place. A secure stow holds the motor in place during transportation when it is subject to high levels of shock and vibration. Failure to stow the motor may result in injury or damage to the unit.

› Constant

The Constant  button is located on the left side of the Foot Pedal, below the One-Boat Network button. It toggles the motor between Constant motor operation and Momentary motor operation. The green CONSTANT  LED on the Indicator Panel will be illuminated when the motor is in Constant motor operation. In Constant motor operation, the Prop will continually run at the speed set by the Speed Control Knob, Wireless Remote, or One-Boat Network app, regardless of whether force is being applied to the Momentary button or Prop ON/OFF button.

NOTICE: The motor will not auto correct to drive straight when it encounters an obstruction.

› Momentary

In Momentary motor operation, the Prop will only run while downward force is applied to the Momentary button. The Momentary button is on the Toe End of the Foot Pedal. Applying downward pressure to the Momentary button will turn the Prop "on." The motor will then run at the speed set by the Speed Control Knob, Wireless Remote, or One-Boat Network app. Removing downward force from the Momentary button will turn the Prop "off." No indicator light is associated with the Momentary button. The Momentary button functions similarly to the Prop ON/OFF button but works in both Normal Mode and Deployment Mode.





CAUTION

If the Prop encounters an obstruction while in Momentary or Constant motor operation while running, the increased electrical current generated by the obstruction will signal the motor to decrease the power to the Prop in order to prevent damage.

FOOT PEDAL OPERATION





› Spot-Lock

The Spot-Lock  button is located on the bottom-right side of the Foot Pedal and is labeled with an anchor symbol. When the Spot-Lock button is pressed, the location of the motor is recorded to a temporary Spot-Lock location. To engage Spot-Lock, press the Spot-Lock button. To disengage, press the Spot-Lock button again. The yellow SPOT-LOCK  LED on the Indicator Panel is illuminated when Spot-Lock is engaged. Spot-Lock can be engaged in Normal Mode and Deployment Mode, and switching between Modes does not cancel Spot-Lock. Spot-Lock can also be controlled with the Wireless Remote or One-Boat Network app.

When engaging Spot-Lock, a tone will be emitted from the Control Head. When disengaging Spot-Lock with the Spot-Lock button, no tone will be emitted. Steering the motor or adjusting the motor speed will cancel Spot-Lock, and tone consisting of several short beeps will be emitted from the Control Head.

NOTICE: In the default Audio Mode, a tone is emitted from the Control Head when Spot-Lock is engaged. If the Audio Mode is set to Alarm Only, a tone will not be emitted when engaging Spot-Lock. To learn more about Audio Modes, refer to the Wireless Remote Owner's Manual online at minnkota.johnsonoutdoors.com.

› One-Boat Network

The One-Boat Network (OBN)  button is located on the left side of the Foot Pedal, below the Indicator Panel. It is a customizable button that may change functions based on user selection. Pressing the OBN button will activate the assigned OBN function. The red One-Boat Network  LED on the Indicator Panel is illuminated when this feature is engaged. Each function has a different LED pattern. AutoPilot is the default OBN function. Review the "One-Boat Network" section of this manual to learn more about customizing the OBN button.

NOTICE: Refer to the "One-Boat Network" section of these instructions to learn how to customize the function of the One-Boat Network button on the Foot Pedal.



AUTOPILOT

AUTOPILOT AND THE ONE-BOAT NETWORK

AutoPilot on the Advanced GPS Navigation System uses an internal compass to keep the trolling motor pointed in the same compass direction. If the One-Boat Network (OBN)  button on the Foot Pedal is customized to the AutoPilot function, the button will engage and disengage AutoPilot.

AUTOPILOT MODES

Two different modes of AutoPilot are available: Locked Heading AutoPilot and Locked Course AutoPilot. Both are collectively referred to as AutoPilot. There are distinct differences between the two AutoPilot Modes and how they control the boat. Both Locked Heading and Locked Course AutoPilot are valuable tools anglers can use for accurate and precise bait presentation. Minn Kota highly recommends getting on the water and trying both Locked Heading AutoPilot and Locked Course AutoPilot in various fishing situations and applications. The AutoPilot mode can be set using the Advanced GPS Navigation Wireless Remote or the One-Boat Network app.

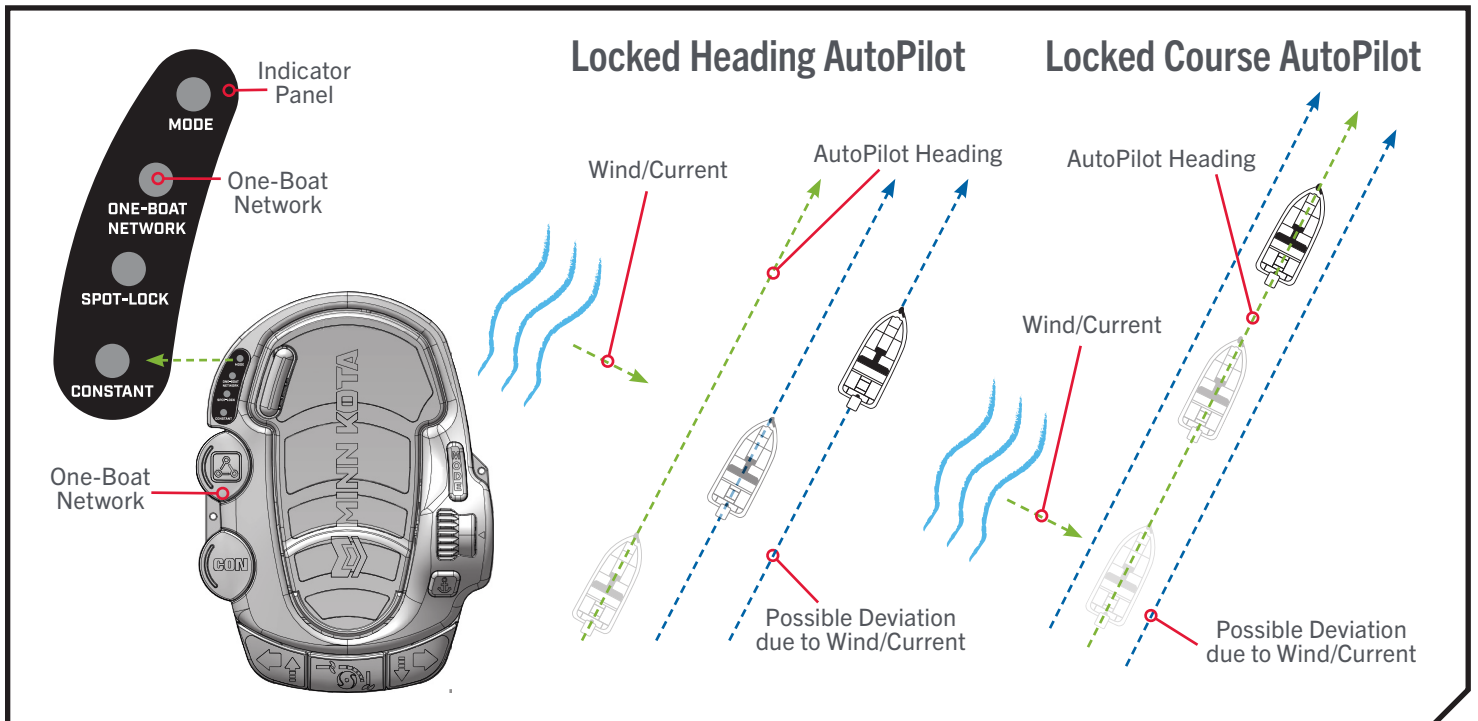

› Locked Heading AutoPilot

AutoPilot uses an internal compass to provide heading lock. When Locked Heading AutoPilot is on, it keeps the motor pointed in the same compass direction. If a manual steering correction is made, Locked Heading AutoPilot locks onto the new compass heading to which the boat was steered. This method of heading tracking does not take into account external forces such as a side wind or currents, which can allow side drift.

› Locked Course AutoPilot

Locked Course AutoPilot uses not only compass heading but also GPS data to correct for crosswinds, currents, and other external forces to keep the boat on the intended course. When Locked Course AutoPilot is turned on, it creates a course that the trolling motor will follow. When the user steers to a new heading, a new course is created. Locked Course AutoPilot will keep the boat on the course in most conditions. When very extreme conditions exist, such as very strong winds or currents, the trolling motor may not have enough power to control the boat smoothly. In these extreme cases, it may be best to use Locked Heading AutoPilot and let the boat move with the wind or current if the motor is not powerful enough to overcome it.

AUTOPILOT

⚠ CAUTION



This unit uses a magnetic compass to detect the direction of travel. The compass can be adversely affected by magnets or large, ferrous metal objects near (within 12" of) the trolling motor control head.

Obstructions on the Prop may cause excessive vibration of the motor control head. This vibration can cause the compass to wander and erratic steering to occur. Clear the obstruction to return the motor to normal operation.

The trolling motor has automatic steering shutdown for safety. In conditions where an obstruction prevents the trolling motor from turning, or in extremely windy conditions, the automatic steering may stop. Any steering input will reset the system to normal.

› Toggle AutoPilot On/Off

1

- a. While the motor is running, AutoPilot can be turned on by pressing the One-Boat Network  button located on the Foot Pedal.
- b. The red One-Boat Network  LED on the Indicator Panel will illuminate when AutoPilot is engaged. While AutoPilot is on, steer the trolling motor as desired.

NOTICE: After steering to a new direction, there is a short delay before the direction is locked in to allow the compass to stabilize. When broad speed changes are made, the AutoPilot heading may change slightly. This is normal.

- c. To turn AutoPilot off, press the One-Boat Network  button.

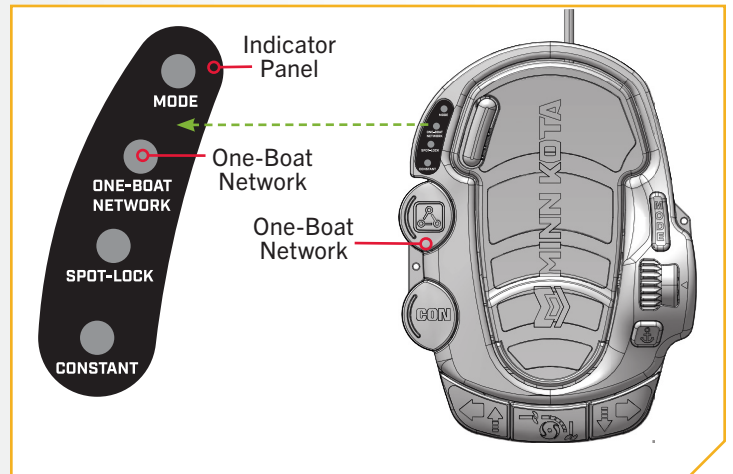

WAYPOINTS

WAYPOINTS AND THE ONE-BOAT NETWORK

Waypoints are saved latitude/longitude positions. They mark a position of interest, such as favorite fishing areas, structures, or marker buoys. Waypoints work similarly to Spot-Locks. If the One-Boat Network (OBN)  button on the Foot Pedal is customized to the Waypoint function, the button will mark WayPoints in the Advanced GPS Navigation System when pressed. For more information on working with Waypoints, please see the Advanced GPS Navigation System or Humminbird owner's manual.

WARNING

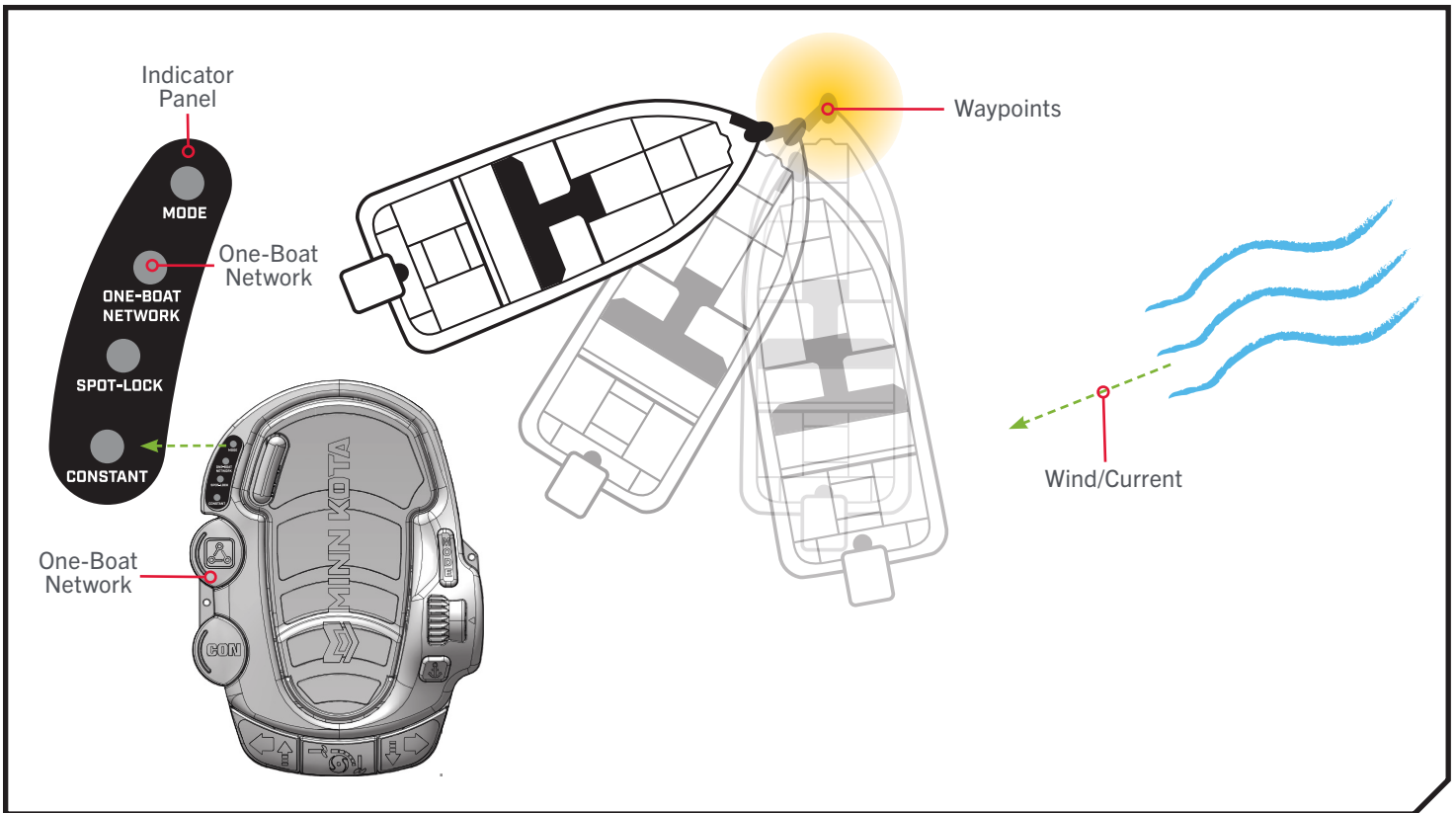

Watch for a turning Prop when working with Waypoints. Auto Prop On is set to "off" by default on the Advanced GPS Navigation System. If Auto Prop On is turned "on," the Prop will automatically turn on when a Waypoint is engaged, even if the engagement is accidental. A turning prop can cause injury. If Auto Prop On is turned "off," the Prop must be enabled before the boat will begin navigating to a Waypoint.



WAYPOINTS

› Mark a WayPoint

1

- a. While the trolling motor is running, mark a Waypoint by pressing the One-Boat Network  button. The red One-Boat Network  LED on the Indicator Panel will briefly illuminate and then turn off to indicate a Waypoint is marked.

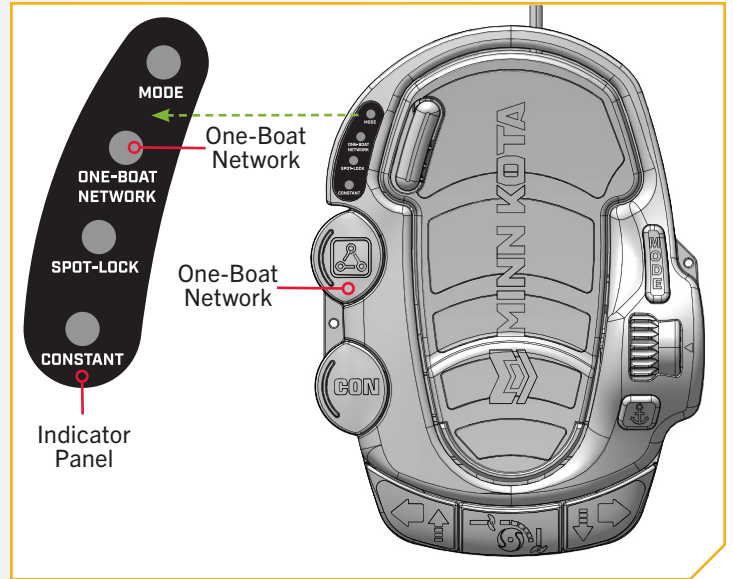

SHALLOW WATER ANCHOR

SHALLOW WATER ANCHOR CONTROL AND THE ONE-BOAT NETWORK

The One-Boat Network allows for control of a Shallow Water Anchor (SWA) when one is paired with the Advanced GPS Navigation Bluetooth Network. SWAs that can pair with the Advanced GPS Navigation system include the Minn Kota Bluetooth enabled Raptor and Talon. For more information on how to pair the SWA with the Advanced GPS Navigation system, please see the SWA owner's manual.

When two Raptors are paired together or two Talons are paired together, the anchor selected and controlled by the Foot Pedal can be Port, Starboard or both. To change the selection of which anchor is selected, use the remote or app paired to the Shallow Water Anchor.

WARNING

Be sure that the Raptor/Talon is clear of obstructions and persons while deploying or retracting. Take care that neither you nor other persons approach the Raptor/Talon too closely while operating, neither with body parts nor with objects. The Raptor/Talon is powerful and may endanger or injure you or others. While the Raptor/Talon is operating, watch out for persons swimming and for floating objects. Persons who lack the ability to run the Raptor/Talon or whose reactions are impaired by alcohol, drugs, medication, or other substances are not permitted to use this product.

CAUTION

The Talon is equipped with a Deployment Notification Alarm. The Alarm is needed to comply with warranty requirements and when properly installed the alarm will only sound when the ignition key is turned on when the Talon is not fully retracted. Boat control may be affected by a deployed Talon. Take note of the Alarm, and always watch to make sure that the Talon is fully retracted while the boat is operating.

CAUTION

The spaces between the Outer Arm, Inner Arm, Spike and brackets of the Raptor can create a pinch point. Do not come in contact with an area of the Raptor that may cause a pinch point while it is moving in any direction to avoid the risk.

SHALLOW WATER ANCHOR

Deploy the Shallow Water Anchor

1

- a. Check to make sure that the Shallow Water Anchor (Raptor/Talon) is powered “on” and paired to the trolling motor.
- b. Locate the One-Boat Network  button located on the Foot Pedal and double-press it to deploy the Raptor/Talon.

NOTICE: The One-Boat Network button does not need to be held in to keep the Raptor/Talon deploying. The Raptor/Talon will automatically continue to deploy when the button is double-pressed until it has reached its full deployment, received input to stop, or anchors.

- c. The red One-Boat Network  LED on the Indicator Panel will steadily flash when the anchor is deploying and stay on when the anchor is at any state of deployment.

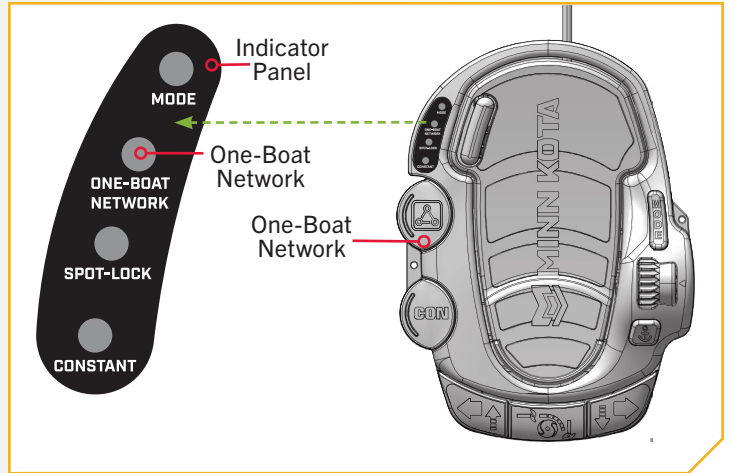

NOTICE: While the Raptor/Talon is deploying, the action can be paused by pressing the One-Boat Network button on the Foot Pedal.

Retract the Shallow Water Anchor

1

- a. Check to make sure that the Shallow Water Anchor (Raptor/Talon) is powered “on” and paired to the trolling motor.
- b. Locate the One-Boat Network  button located on the Foot Pedal and press it to retract the Raptor/Talon.

NOTICE: While the Raptor/Talon is retracting, the action can be paused by pressing the One-Boat Network button on the Foot Pedal.

- c. The red One-Boat Network  LED on the Indicator Panel will steadily flash when the anchor is retracting and stay on when the anchor is at any state of deployment.

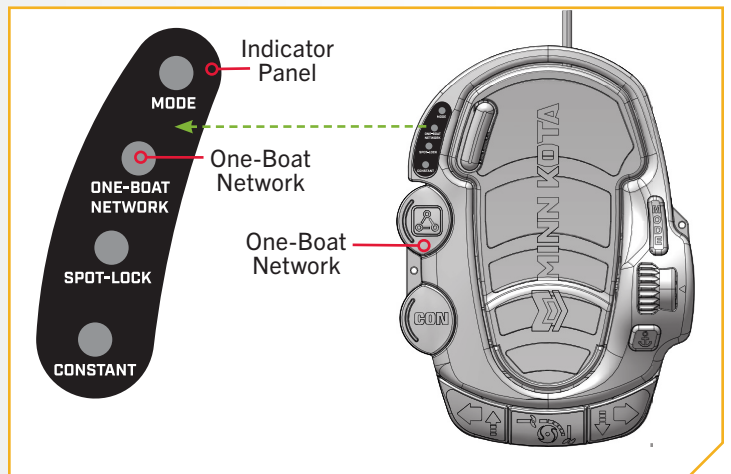

SPOT-LOCK

HOW SPOT-LOCK WORKS

Spot-Lock uses a single point of reference that is recorded when the Spot-Lock  button is pressed. The reference point is a set of GPS coordinates captured at the location of the trolling motor at the moment the button is pressed. This point is recorded and can be saved into one of the Spot-Lock memory locations. Spot-Lock works by recognizing the GPS coordinates and will automatically navigate the boat to keep it at the Spot-Lock location. If the motor recognizes it is not positioned at the Spot-Lock location, it will control motor speed and direction in an attempt to keep the motor on the Spot-Lock. For more specific instructions on using Spot-Lock, refer to the Wireless Remote owner's manual online at minnkota.johnsonoutdoors.com.

NOTICE: Spot-Lock is based on the location of the trolling motor, not on the location or direction of the boat. Outside forces such as wind and current will cause the boat to move. Spot-Lock will navigate to maintain the motor on the Spot-Lock location, regardless of the position of the boat.

WARNING

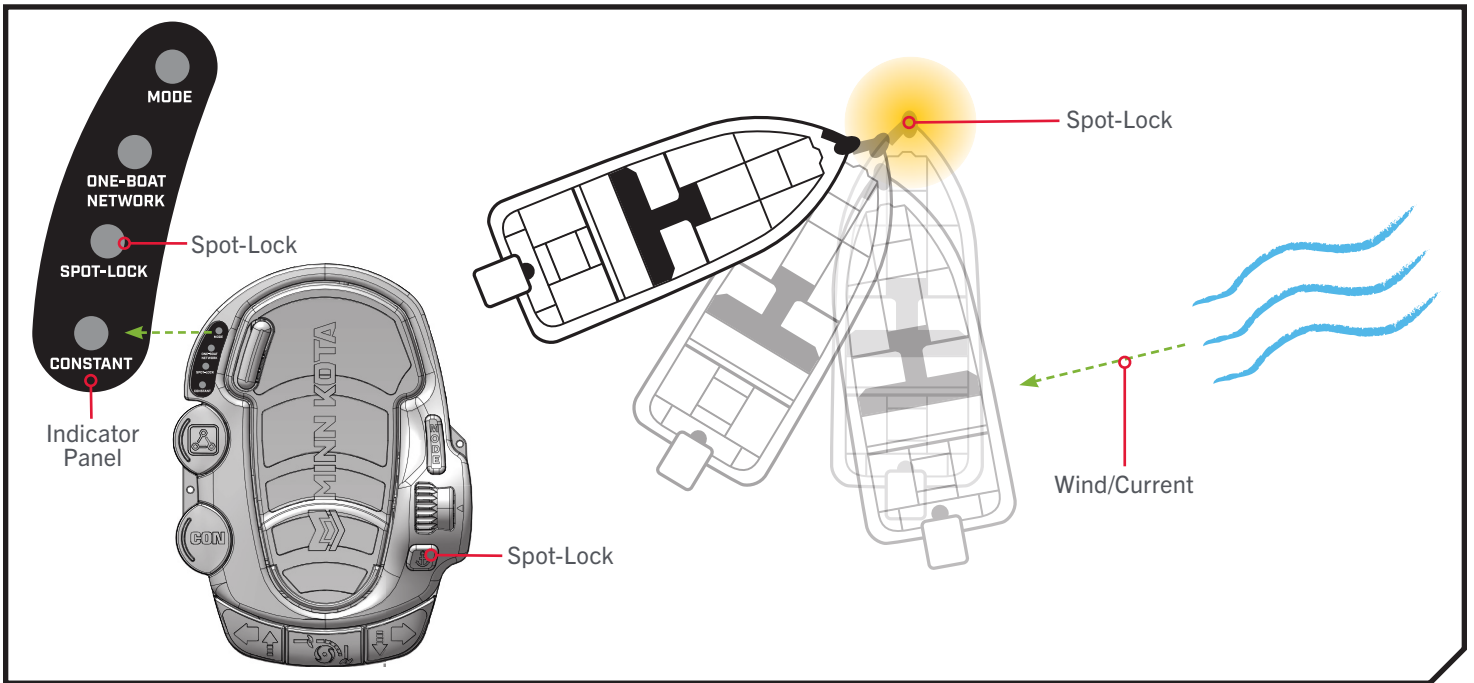

Watch for a turning Prop when working with Spot-Lock. The Prop will automatically turn on when Spot-Lock is engaged, even if the engagement is accidental. A turning Prop can cause injury. The Prop will turn "on" for Spot-Lock, regardless of the Prop Auto On setting used on the other control methods in the Advanced GPS Navigation System.



SPOT-LOCK

› Toggle Spot-Lock On/Off

1

- a. While the motor is running, Spot-Lock can be turned on by pressing the Spot-Lock  button located on the Foot Pedal. The yellow SPOT-LOCK  LED on the Indicator Panel is illuminated when Spot-Lock is engaged.

NOTICE: In the default Audio Mode, a tone is emitted from the Control Head when Spot-Lock is engaged. If the Audio Mode is set to Alarm Only, a tone will not be emitted when engaging Spot-Lock. To learn more about Audio Modes, refer to the Wireless Remote owner's manual online at minnkota.johnsonoutdoors.com.

- b. To disengage Spot-Lock when engaged, press the Spot-Lock button again, or press any button on the Foot Pedal to manually steer the trolling motor.

NOTICE: Adjusting the Prop speed or manually steering the motor will disengage Spot-Lock, and an error tone consisting of several short beeps will emit from the Control Head. Manually steering or adjusting the Prop speed with the Wireless Remote or One-Boat Network app will also cancel Spot-Lock.

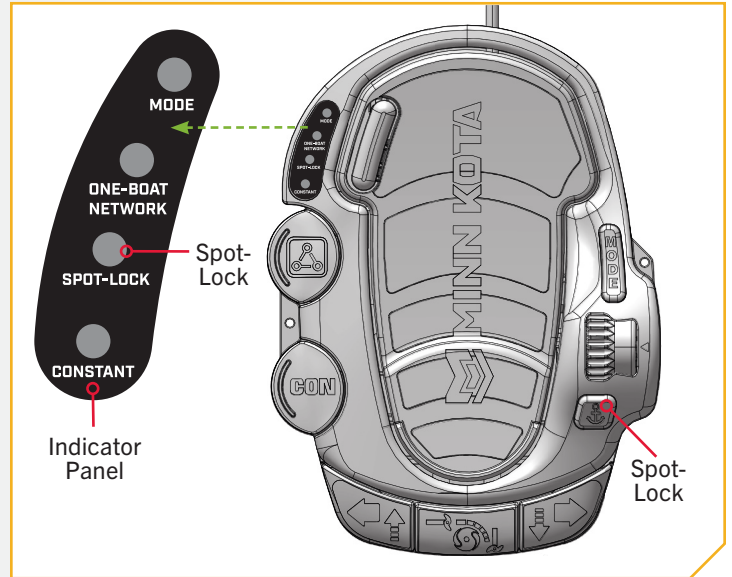

NOTICE: If the Spot-Lock button is accidentally pressed, press the Spot-Lock button again to cancel Spot-Lock.

SERVICE & MAINTENANCE

PROP REPLACEMENT

TOOLS AND RESOURCES REQUIRED >

- 9/16" Deep Well Socket

INSTALLATION >

1

CAUTION

Disconnect the motor from all sources of power before beginning any prop work or maintenance.

- Hold the Prop and loosen the Prop Nut with a 9/16" Deep Well Socket.
- Remove the Prop Nut and Prop Washer.

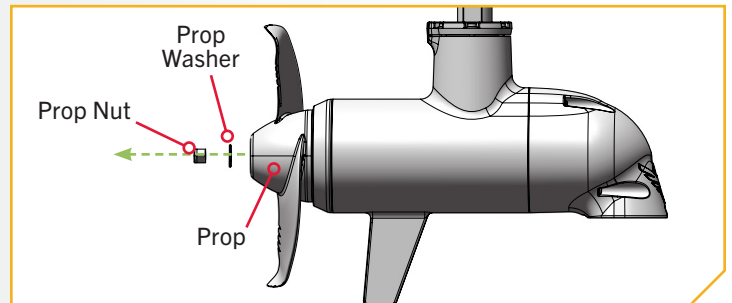

NOTICE: If the Drive Pin is sheared or broken, hold the Armature Shaft stationary with a Flat-Blade Screwdriver by pressing into the slot on the end of the shaft while loosening the Prop Nut.

2

- Turn the old Prop so it is horizontal and pull it straight off. If the Drive Pin falls out, push it back in.

CAUTION

If the Prop does not readily slide off, take care not to bend the Armature Shaft. Pull the Prop evenly off the Armature Shaft.

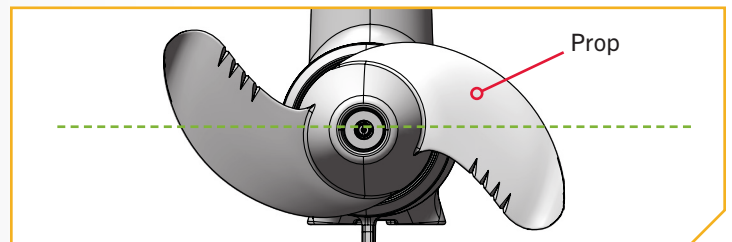

3

- Align the new Prop so it is horizontal and parallel with the Drive Pin. Slide the Prop onto the Armature Shaft and Drive Pin until it is seated against the lower unit.
- Reinstall the Prop Washer and Prop Nut onto the end of the Armature Shaft. While holding the Prop horizontal, tighten the Prop Nut with a 9/16" Deep Well Socket. Tighten the Prop Nut to 25-35 in-lb.

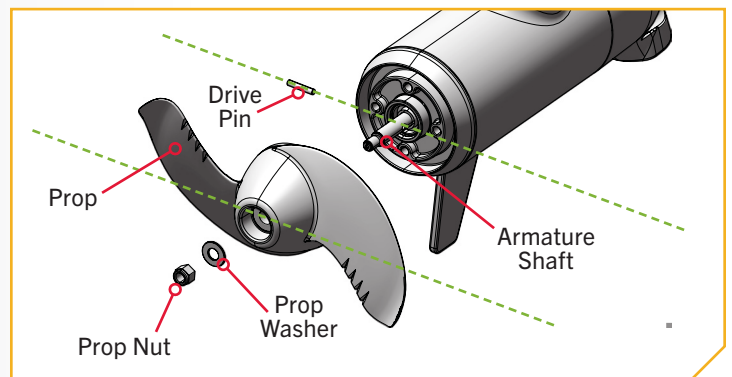

CAUTION

Do not over-tighten as this can damage the Prop.

GENERAL MAINTENANCE



GENERAL MAINTENANCE

- After use, the entire motor should be rinsed with freshwater. This series of motor is not equipped for saltwater exposure.
- The composite shaft requires periodic cleaning and lubrication for proper retraction and deployment. A coating of an aqueous-based silicone spray will improve operation.
- The Prop must be inspected and cleaned of weeds and fishing line after every use. Fishing line and weeds can get behind the Prop, damage the seals and allow water to enter the motor.
- The Prop is designed to provide weed-free operation with very high efficiency. To maintain this top performance, the leading edge of the blades must be kept smooth. If they are rough or nicked from use, restore to smoothness by sanding with fine sandpaper.
- Verify that the Prop Nut is secure each time the motor is used.
- To prevent accidental damage during transportation or storage, disconnect the battery whenever the motor is off the water. For prolonged storage, lightly coat all metal parts with an aqueous-based silicone spray.
- When using lithium batteries, it is best to charge them right before using them. Storing lithium batteries in a fully charged state for long periods of time may cause damage to the batteries. Check with the battery manufacturer for specifics on the battery.
- For maximum battery life of all other batteries except lithium, recharge the battery(s) as soon as possible after use. For maximum motor performance, restore the battery to full charge prior to use. Check with the battery manufacturer for specifics on the battery.
- Keep battery terminals clean with fine sandpaper or emery cloth.
- Stow the motor after each use to allow water to drain from the Steering Housing. Water that sits in the steering housing when the motor is not in use may cause damage.
- When the motor is deployed, periodically check that the area between the Mount and Steering Housing is clean and free of debris. The Mount contains a Stow Pad that contacts the Steering Housing when stowed. If debris such as dirt, gravel, weeds, or fishing line enters this space, it may create an obstruction on the Stow Pad and prevent a secure stow. Periodically clean this space to ensure a secure stow.
- Keep the Foot Pedal well dry and clean. Debris that gets in the Foot Pedal can cause interference of pedal operation. It is recommended to use compressed air to clean the Foot Pedal after each use.
- Periodically check the motor for loose hardware and damaged components.

TROUBLESHOOTING

1. Motor fails to run or lacks power:
 - Check the state of the batteries and replace if necessary. Low battery voltage will cause an error.
 - Check battery connections for proper polarity.
 - Make sure the battery is charged.
 - Make sure terminals are clean and corrosion-free. Use fine sandpaper or emery cloth to clean terminals.
 - Check circuit protection devices.
 - Check battery water level. Add water if needed.
2. Motor loses power after a short running time:
 - Check battery charge. If low, restore to full charge, or replace.
3. You experience Prop vibration during normal operation:
 - Remove and rotate the Prop 180°. See removal instructions in the "Prop Replacement" section. Replace Prop if worn.



- 4. Experiencing interference with your fish finder:
 - You may, in some applications, experience interference in your fish finder display. We recommend that you use a separate deep cycle marine battery system for your trolling motor. If problems still persist, call our service department at 1-800-227-6433.
- 5. Motor contacts an object while trimming, causing an audible tone:
 - Reverse the direction of trimming to clear motor from obstruction.
- 6. Motor contacts an object while stowing, causing an audible tone:
 - Reverse the current cycle to clear the motor from the obstruction. Reverse the stow/deploy action with the wireless remote, One-Boat Network app, or by pressing the Stow/Deploy button on the Foot Pedal.
- 7. Motor fails to trim:
 - Check main lift-belt tension per the "Motor Adjustments" section.
 - Conduct a Trim Reset procedure using the Indicator Panel at the base of the mount.
 - a. To conduct a Trim Reset, press the Power button on the Indicator Panel three times consecutively within a two-second period.
 - b. The blue System Status LED and orange Stowed LED will flash continuously while the Ulterra QUEST goes through an automated sequence.
 - c. The motor will rotate into the Stow Orientation position.
 - d. The motor will trim up to the Mount and then trim down approximately six inches.
 - e. The flashing blue orange Stowed LED will turn off, and the flashing blue System Status LED will become solid blue.

WARNING

During the Trim Reset procedure, the motor will go into an automated sequence. Keep fingers clear of all hinges, pivot points and all moving parts. Ensure that the motor or parts of the motor do not contact the boat, trailer, persons, or any other obstruction.

- 8. Motor fails to stow or deploy:
 - Check for obstructions preventing the motor from deploying or stowing.
 - Check charge state of trolling motor batteries. If trolling motor battery icon on remote is flashing, battery charge is too low for operation.
 - If unable to stow by any other method, see the "Emergency Stow Procedures" section for details on manually stowing the motor.
- 9. Prop will not turn on:
 - Ensure batteries are sufficiently charged.
 - For safety reasons, there is a Prop Lockout Region (approx. 16" from bottom of Mount to center of Lower Unit). Ensure that the Lower Unit is not in this region.
- 10. Experiencing flashing red System Status  LED on the Indicator Panel:
 - The trolling motor is communicating that there is an error. Check the Wireless Remote Diagnostic menu for an error code, then refer to the Wireless Remote owner's manual for information on error codes and solutions. Correct the error and cycle power to the trolling motor. If the LED continues to flash red, please contact the Minn Kota service department.

NOTICE: For all other malfunctions, visit an Authorized Service Center. You can search for an Authorized Service Center in your area by visiting minnkota.johnsonoutdoors.com, or by calling our customer service number at 800-227-6433.

FOR FURTHER TROUBLESHOOTING AND REPAIR



FOR FURTHER TROUBLESHOOTING AND REPAIR

We offer several options to help you troubleshoot and/or repair your product. Please read through the options listed below.



Buy Parts Online

You can buy parts online directly from our website at minnkota.johnsonoutdoors.com. From screws to sideplates, you can order replacement parts for your Minn Kota products.



Frequently Asked Questions

Find answers to general inquiries, battery and rigging installation, and networking scenarios. We have FAQs available on our website at minnkota.johnsonoutdoors.com to help answer all of your Minn Kota questions.



Call Us (for U.S. and Canada)

Our consumer service representatives are available Monday – Friday between 7:00 a.m. – 4:30 p.m. CST at 800-227-6433. If you are calling to order parts, please have the 11-character serial number from your product, specific part numbers, and credit card information available. This will help expedite your call and allow us to provide you with the best consumer service possible. You can reference the parts list located in your manual to identify the specific part numbers.



Contact Us

You can contact our consumer service department with questions regarding your Minn Kota products. To inquire, visit minnkota.johnsonoutdoors.com.



Authorized Service Centers

Minn Kota has over 800 authorized service centers in the United States and Canada where you can purchase parts or get your products repaired. Please visit our website to locate a service center in your area.



Scan to visit
Minn Kota
service online.



COMPLIANCE STATEMENTS

ENVIRONMENTAL COMPLIANCE STATEMENT

It is the intention of JOME to be a responsible corporate citizen, operating in compliance with known and applicable environmental regulations, and a good neighbor in the communities where we make or sell our products.

WEEE DIRECTIVE

EU Directive 2002/96/EC “Waste of Electrical and Electronic Equipment Directive (WEEE)” impacts most distributors, sellers, and manufacturers of consumer electronics in the European Union. The WEEE Directive requires the producer of consumer electronics to take responsibility for the management of waste from their products to achieve environmentally responsible disposal during the product life cycle.

WEEE compliance may not be required in your location for electrical & electronic equipment (EEE), nor may it be required for EEE designed and intended as fixed or temporary installation in transportation vehicles such as automobiles, aircraft, and boats. In some European Union member states, these vehicles are considered outside of the scope of the Directive, and EEE for those applications can be considered excluded from the WEEE Directive requirement.

This symbol (WEEE wheelee bin) on product indicates the product must not be disposed of with other household refuse. It must be disposed of and collected for recycling and recovery of waste EEE. Johnson Outdoors Inc. will mark all EEE products in accordance with the WEEE Directive. It is our goal to comply in the collection, treatment, recovery, and environmentally sound disposal of those products; however, these requirements do vary within European Union member states. For more information about where you should dispose of your waste equipment for recycling and recovery and/or your European Union member state requirements, please contact your dealer or distributor from which your product was purchased.

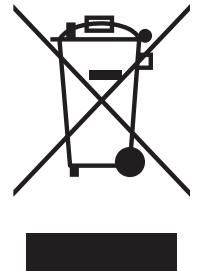

DISPOSAL

Minn Kota motors are not subject to the disposal regulations EAG-VO (electric devices directive) that implements the WEEE directive. Nevertheless never dispose of your Minn Kota motor in a garbage bin but at the proper place of collection of your local town council.

Never dispose of battery in a garbage bin. Comply with the disposal directions of the manufacturer or his representative and dispose of them at the proper place of collection of your local town council.

REGULATORY COMPLIANCE INFORMATION

› Advanced GPS Navigation

For regulatory information on motors that come factory installed with Advanced GPS Navigation, please refer to the Advanced GPS Navigation Owner's Manual online at minnkota.johnsonoutdoors.com.

FCC COMPLIANCE



FCC COMPLIANCE

This device complies with Part 15 of the FCC rules. **Operation is subject to the following two conditions:**

1. This device may not cause harmful interference.
2. This device must accept any interference that may be received, including interference that may cause undesired operation.

Changes or modifications not expressly approved by Johnson Outdoors Marine Electronics, Inc. could void the user's authority to operate this equipment.

NOTICE: This equipment has been tested and found to comply with the limits for a Class B digital device, pursuant to part 15 of the FCC Rules. These limits are designed to provide reasonable protection against harmful interference in a residential installation. This equipment generates, uses and can radiate radio frequency energy and, if not installed and used in accordance with the instructions, may cause harmful interference to radio communications. However, there is no guarantee that interference will not occur in a particular installation. **If this equipment does cause harmful interference to radio or television reception, which can be determined by turning the equipment off and on, the user is encouraged to try to correct the interference by one or more of the following measures:**

- Reorient or relocate the receiving antenna.
- Increase the separation between the equipment and receiver.
- Connect the equipment into an outlet on a circuit different from that to which the receiver is connected.
- Consult the dealer or an experienced radio/TV technician for help.

INDUSTRY CANADA COMPLIANCE

This product meets the applicable Industry Canada technical specifications. Operation is subject to the following two conditions: (1) this device may not cause interference, and (2) this device must accept any interference, including interference that may cause undesired operation of the device.

ENVIRONMENTAL RATINGS

Ambient operating temperature range: -10C to 50C

Ambient operating humidity range: 5% to 95%

Maximum operating altitude: 10,000 feet



PARTS DIAGRAM & PARTS LIST

ULTERRA QUEST - 90/115 THRUST - 24/36 VOLT - 45"/60"/72" SHAFT

The parts diagram and parts list provide Minn Kota® WEEE compliance disassembly instructions. For more information about where you should dispose of your waste equipment for recycling and recovery and/or your European Union member state requirements, please contact your dealer or distributor from which your product was purchased. Tools required, but not limited to: flat head screwdriver, Phillips screwdriver, socket set, pliers, wire cutters.

ULTERRA QUEST CONTROL HEAD >

> Control Head Parts Diagram

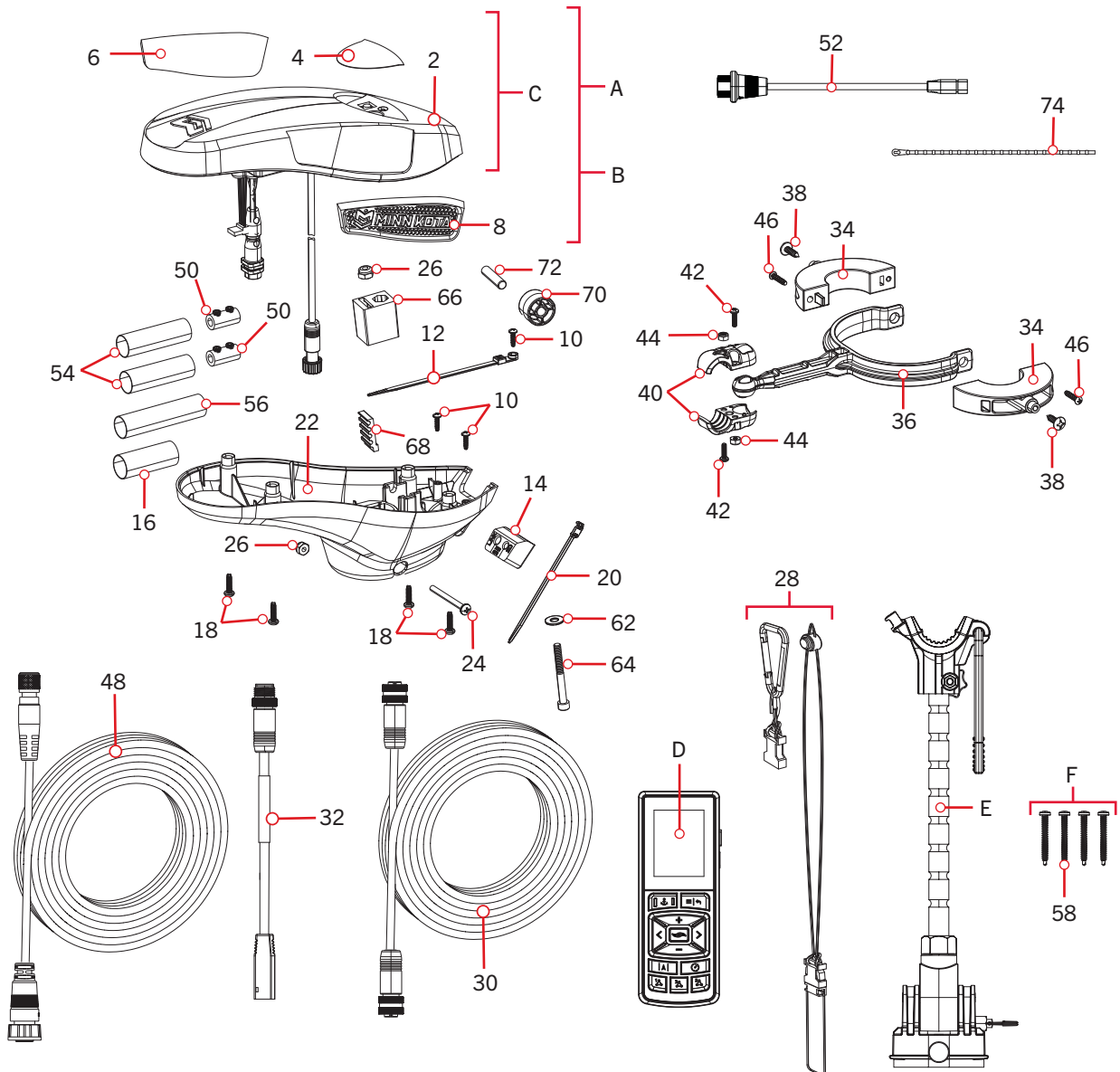

PARTS DIAGRAM & PARTS LIST

Control Head Parts List

Assembly	Part #	Description	Notes	Quantity
A	2774190	CONTROLLER KIT 4.0 QUEST FW	*DUAL SPECTRUM CHIRP*	1
B	2774191	CONTRLLR KT 4.0 QUEST FW w/GND	*MEGA SIDE IMAGING*	1
C	2770247	CTRL BOX COVER QUEST FW		1
D	411690-1	TROLLING MOTOR REMOTE		1
E	2992371	STABILIZER, BWMT ES TM ASM	*72**	1
F	2994955	BAG, ASM MKA-60 STABILIZER	*72**	1
Item	Part #	Description	Notes	Quantity
2	2200220	CONTROL BOX COVER, BLACK		1
4	2395560	DECAL,PUSH BTN,ULT FX,BLK		1
6	2205560	DECAL,CTRL BOX MK RIGHT FW		1
8	2205565	DECAL,CTRL BOX MK LEFT FW		1
10	2203441	SCREW-#6 X 1/2" THRD FORM,SSTL		3
12	2206302	TIE WRAP,SCREW MOUNT 6.3"		1
14	2206711	PLUG, RUBBER, 2D	*DUAL SPECTRUM CHIRP*	1
	2206710	PLUG, RUBBER, DI/SI	*MEGA SIDE IMAGING*	1
16	2205412	SHRINK TUBE-.75 ID X 2"		1
18	2372100	SCREW-#8-18 X 5/8 THD* (SS)		4
20	2206301	TIE WRAP, LOW PROFILE 8"		1
22	2202520	CONTROL BOX BASE, ULT/UTX FW		1
24	2263406	SCREW-#10-24 X 2" S/S PPH		1
26	2333101	NUT-HEX #10-24 UNC-2B NYL SS		2
28	2390802	LANYARD w/CARABINER IP RMT U2		1
30	490637-4	CABLE, ETH, M12-M12, BRAID,30'		1
32	490380-1	CABLE, ETHERNET PIGTAIL-700 HD		1
34	2201530	COLLAR HALF, COIL CORD	*72**	2
36	2201531	COLLAR ARM, COIL CORD	*72**	1
38	2203424	SCREW-#10-12 x.75 PTH SS	*72**	2
40	2200860	CLAMP-BALL,COIL CORD SLDR	*72**	2
42	830-064	SCREW-#6-32X1/2" TORX PH SS ND	*72**	2
44	2323110	NUT-HEX, 6-32 NYLOK SS	*72**	2
46	2203460	SCREW-#8 X 0.75 PPH HI-LO SS	*72**	2
48	490636-3	CABLE, ADPTR, 14P, BRAID, 110"	*DUAL SPECTRUM CHIRP*	1
	490635-1	CABLE, INT MSI, BRAID-INSTINCT	*MEGA SIDE IMAGING*	1
50	2375444	SPLICER, 6-10 AWG, TIN PLTD		2
52	2994961	BAG ASM, CABLE,ADPTR, 490537-2	*490537-2* *MKR-MI-1* *DUAL SPECTRUM CHIRP* *MEGA SIDE IMAGING*	1
54	2205413	SHRINK TUBE-3/4 X 2.25"		2
56	2205415	SHRINK TUBE-.472 ID X 5"		1
58	2383475	SCREW - #8-18 X 1 1/2 SELF DR SS	*72**	4

▲ Not shown on Parts Diagram.

* This part is included in an assembly and cannot be ordered individually.

PARTS DIAGRAM & PARTS LIST



Item	Part #	Description	Notes	Quantity
62	2201721	WASHER - #10 SAE.), SS		1
64	2203411	SCREW-#10-24,SHCS,SS, RIE 4606		1
66	2202800	BLOCK-BELT		1
68	2200800	BELT-RACK, LOWER		1
70	2202335	PULLEY, BELY TOP		1
72	2202635	PIN-DOWEL, 1/4" OD SS		1
74	2206304	TIE WRAP, REUSABLE RED, 6"		1
▲	2207124	MANUAL, ULTERRA		1
▲	2207125	MANUAL, INSTL GD, ULTERRA		1
▲	2297165	MANUAL-DISCLAIMER,DNLOAD INFO		1
▲	2294950	INSTRUCTIONS,OBV & REMOTE PAIR		1
▲	2397115	GUIDE-QUICK REFERENCE iP 4.0		1
▲	2397110	MANUAL, iPILOT 4.0		1
▲	2207130	BRUSHLESS QS SETUP GUIDE		1
▲	2207126	QK REF GUIDE,ULT Q/INST Q		1
▲	2395540	DECAL, COMPLIANCE, KIT 1.6, 3.0		1
▲	2377179	INSTR. SHEET, MKA-60 STABILIZER	*72**	1
▲	2206819	LABEL-CARTON "CAUTION HEAVY"		1

▲ Not shown on Parts Diagram.

* This part is included in an assembly and cannot be ordered individually.



PARTS DIAGRAM & PARTS LIST



ULTERRA QUEST MOTOR >

> 24/36 Volt 90/115 Thrust Motor Parts Diagram

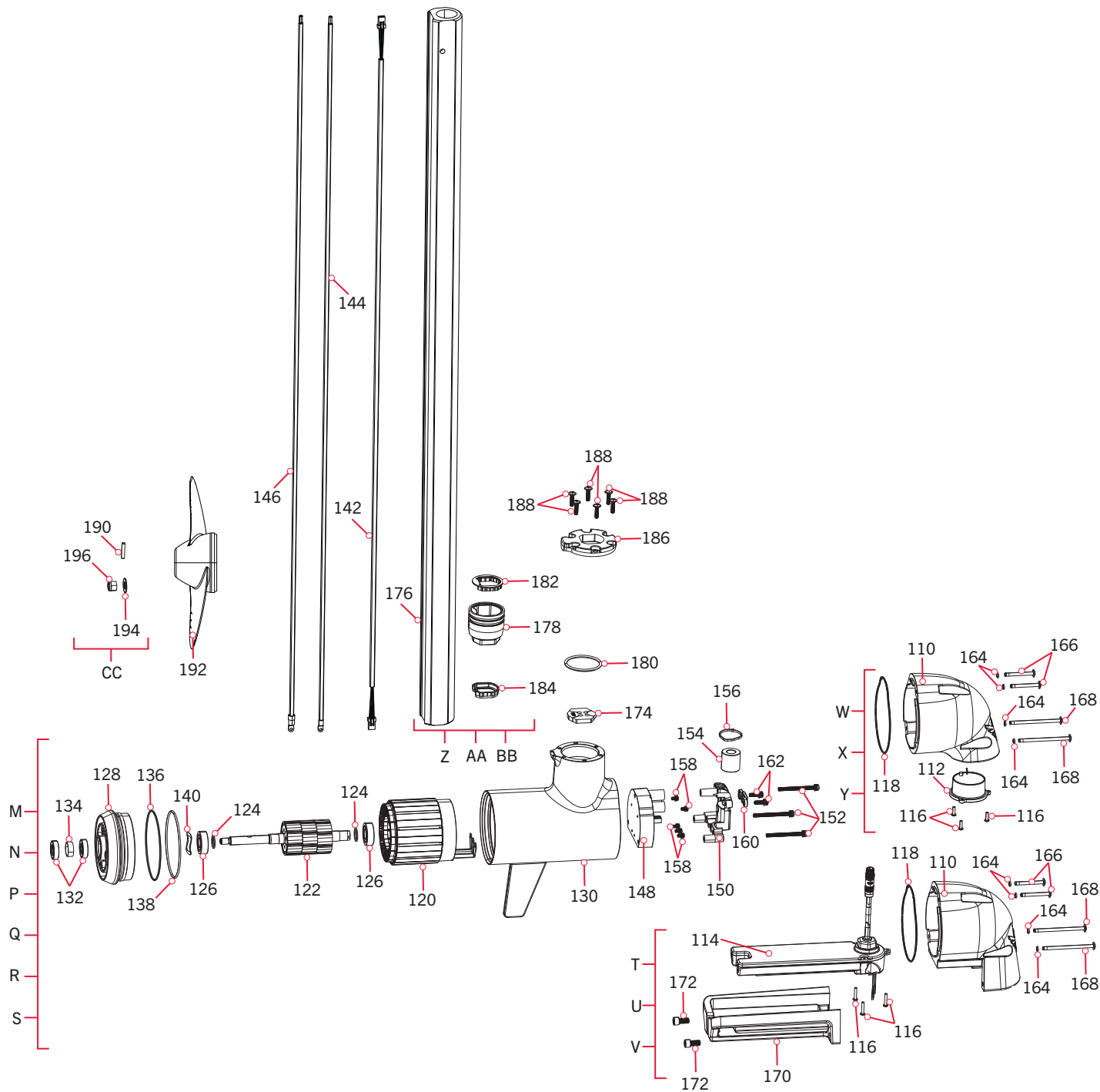

PARTS DIAGRAM & PARTS LIST

▶ 24/36 Volt 90/115lb Thrust Motor Parts List

Assembly	Part #	Description	Notes	Quantity
M	2441060	MTR ASY 85/115#DSC FW BLK	*45"* *DUAL SPECTRUM CHIRP*	1
N	2441062	MTR ASY 85/115#DSC FW BLK	*60"* *DUAL SPECTRUM CHIRP*	1
P	2441063	MTR ASY 90/115#DSC FW BLK	*72"* *DUAL SPECTRUM CHIRP*	1
Q	2441080	MTR ASY 85/115#MSI FW BLK	*45"* *MEGA SIDE IMAGING*	1
R	2441082	MTR ASY 85/115#MSI FW BLK	*60"* *MEGA SIDE IMAGING*	1
S	2441083	MTR ASY 90/115#MSI FW BLK	*72"* *MEGA SIDE IMAGING*	1
T	2773072	MSI FRONT END 45" QUEST	*45"* *MEGA SIDE IMAGING*	1
U	2773074	MSI FRONT END 60" QUEST	*60"* *MEGA SIDE IMAGING*	1
V	2773075	MSI FRONT END 72" QUEST	*72"* *MEGA SIDE IMAGING*	1
W	2773031	DSC FRONT END 45" QUEST	*45"* *DUAL SPECTRUM CHIRP*	1
X	2773033	DSC FRONT END 60" QUEST	*60"* *DUAL SPECTRUM CHIRP*	1
Y	2773035	DSC FRONT END 72" QUEST	*72"* *DUAL SPECTRUM CHIRP*	1
Z	2991064	BL ASM FW DSC/MSI 45"U2,T3	*SHAFT* *45"*	1
AA	2991065	BL SHAFT ASM 60" UTX,ULT,T3,RT	*SHAFT* *60"*	1
BB	2991066	BL SHAFT ASM 72" ULT, T3	*SHAFT* *72"*	1
CC	2992604	BAG ASSM, PROP HARDWARE		1
Item	Part #	Description	Notes	Quantity
110	✘	FRONT ENDBELL, US3, FW	*DUAL SPECTRUM CHIRP*	1
	✘	FRONT ENDBELL, MSI, FW	*MEGA SIDE IMAGING*	1
112	✘	DSC XDUCER ASSY 62" HW T	*DUAL SPECTRUM CHIRP* *45"*	1
	✘	DSC XDUCER ASSY 73" HW T	*DUAL SPECTRUM CHIRP* *60"*	1
	✘	DSC XDUCER ASSY 86" HW T	*DUAL SPECTRUM CHIRP* *72"*	1
114	✘	BI MSI 67 FOR U2-440494-2	*MEGA SIDE IMAGING* *45"*	1
	✘	BI MSI 79 FOR U2-440494-4	*MEGA SIDE IMAGING* *60"*	1
	✘	BI MSI 91 FOR U2-440494-5	*MEGA SIDE IMAGING* *72"*	1
116	✘	SCREW-#6-32X1/2" TORX PH SS ND		3
118	880-032	SEAL-FRONT, BL MOTORS		1
120	✘	STATOR ASSEMBLY		1
122	✘	ROTOR ASSEMBLY		1
124	✘	WASHER BEARING		2
126	✘	BALL BEARING		2
128	✘	REAR ENDBELL, FW PAINT		1
130	✘	CENTER HSG, FW PAINT		1
132	✘	SEAL		2
134	✘	PAPER TUBE - SEAL BORE		1
136	✘	O-RING		1
138	✘	O-RING		1
140	✘	WASHER-WAVE		1

▲ Not shown on Parts Diagram.

✘ This part is included in an assembly and cannot be ordered individually.

PARTS DIAGRAM & PARTS LIST



Item	Part #	Description	Notes	Quantity
142	195-030	CABLE-COM 22GA TWST PAIR 62.38	*45**	1
	195-032	CABLE-COM 22GA TWST PAIR 76.25	*60**	1
	195-033	CABLE-COM 22 GA TWST PAIRS	*72**	1
144	640-470	LEADWIRE RED 8 AWG 64.88"	*45**	1
	640-472	LEADWIRE RED 8 AWG 78.75"	*60**	1
	640-483	LEADWIRE RED 6 AWG 90.13"	*72**	1
146	640-420	LEADWIRE BLK 8 AWG 64.88	*45**	1
	640-422	LEADWIRE BLK 8 AWG 78.75"	*60**	1
	640-433	LEADWIRE BLK 6 AWG 90.13"	*72**	1
148	2994130	INVERTER ASM, 24/36V, BL		1
150	979-031	STRAIN RELIEF,BTM MACH WIRETAB		1
152	830-118	SCREW-DBL SEM M5X.8MMX60MM		3
154	2307318	FERRITE BEAD, BL	*DUAL SPECTRUM CHIRP*	1
	2307319	FERRITE BEAD, BRUSHLESS	*MEGA SIDE IMAGING*	1
156	9953310	TIE WRAP-8.5"		1
158	830-123	SCREW-M4 X .7X8MM HEX DBL SEMS		5
160	979-022	STRAIN RELIEF, TOP CAST		1
162	830-121	SCREW-M5 X .8X18 PPH ZPS		2
164	701-010	O-RING, SCREW		4
166	830-105	SCREW-FRONT, TOP, RAW, BL MTR		2
168	830-106	SCREW-FRONT, BTM RAW, BL MTR		2
170	792-030	GUARD-SONAR, MSI, FW PAINT	*MEGA SIDE IMAGING*	1
172	830-110	SCREW-5-16-18 X 5/8 SHCS SS	*MEGA SIDE IMAGING*	2
174	880-041	SEAL-WIRE, BL MTR, UNIV. CHIRP	*DUAL SPECTRUM CHIRP*	1
	880-040	SEAL-WIRE, BL MTR, MSI/MDI	*MEGA SIDE IMAGING*	1
176	✘	TUBE-1CM, BLK 45", 1.5 X .875	*45**	1
	✘	TUBE-1CM, BLK 60", 1.5 X .875	*60**	1
	✘	TUBE-3CM,BLK 72", 1.5X.875 CBOR	*72**	1
178	✘	PLUG, COMP SHAFT, PAINTED		1
180	2294630	O-RING, 226, 70 SHORE A		1
182	✘	SEAL-TOP SHAFT, BL, CLR		1
184	✘	SEAL-LWR SHAFT, BL, CLR		1
186	2206452	PLATE, CLAMP, PAINTED, BELT		1
188	830-013	SCREW-M5 X .8 FSHCS SS CTD		6
190	2262659	PIN-DRIVE 1" X 3/16" SS 17-4		1
192	2321170	PROP, POWER REAMED		1
194	2091701	WASHER-PROP (LARGE) MAX101		1
196	2093101	NUT-PROP,NYLOC,LG,MX101 3/8 SS		1
▲	2375404	SHRINK TUBE-24MM IDx1.25" ADHS	*MEGA SIDE IMAGING*	1
▲	2005764	DECAL,SERIAL NO., BRUSHLESS LU		1

▲ Not shown on Parts Diagram.

✘ This part is included in an assembly and cannot be ordered individually.



ULTRERA QUEST STEERING HOUSING >

> Steering Housing Parts Diagram

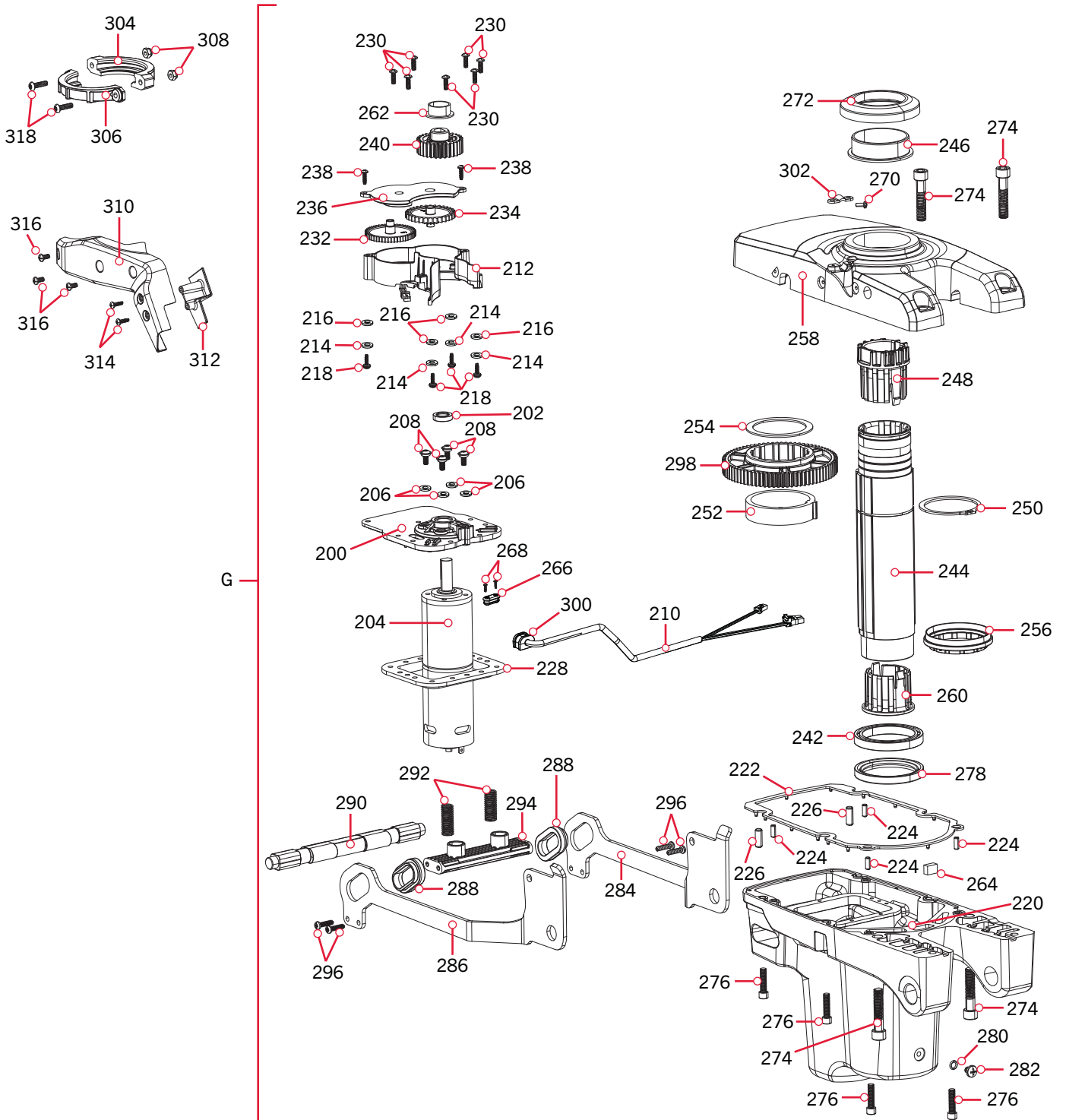

PARTS DIAGRAM & PARTS LIST

› Steering Housing Parts List

Assembly	Part #	Description	Notes	Quantity
G	2996530	ASM, STEERING, FW, BLK		1
Item	Part #	Description	Notes	Quantity
200	✘	PLATE, MOTOR MNT, STEERING		1
202	✘	SEAL,ID 12MM, OD 20MM, T 5MM		1
204	✘	MOTOR, 24 VDC, 1:130 GEARBOX		1
206	✘	O-RING, 3/16 ID X 3/8 OD		4
208	✘	SCREW-M5X.8X12,FLANGED BTN HD		4
210	✘	STEERING CORD ASM		1
212	✘	SENSOR,STEERING,ROTATIONAL,I/T		1
214	✘	SEALING WASHER, RUBBER		4
216	✘	WASHER-FLAT #6 S/S		4
218	✘	SCREW-#6 X 1/2" THRD FORM,SSTL		4
220	✘	HSG-BTM, STRING,SW,BLK TERR		1
222	✘	SEAL, STEERING HOUSING SPLIT		1
224	✘	PIN-DOWEL, 3/16 X 1/2, SS		4
226	✘	PIN-DOWEL, 1/4" X 5/8" SS		2
228	✘	GASKET, MOTOR HOUSING,STEERING		1
230	✘	SCREW-#8-32 X 9/16, PPH, SSTL		7
232	✘	GEAR-STEER SENSOR,51T,w/MAGNET		1
234	✘	GEAR-TRIM, 14T		1
236	✘	COVER, STEER SENSOR GEARS		1
238	✘	SCREW-#6 X 1/2" THRD FORM,SSTL		2
▲	✘	TIE WRAP-4" BLACK(#21041)		1
240	✘	GEAR, 30 TOOTH,PINION,STEERING		1
242	✘	BRG, 55 X 72 X 9MM, SSTL		1
244	✘	OUTPUT TUBE, ANDIZED		1
▲	✘	O-RING,-139,NOM ID 2.25,		1
246	✘	BUSHING, 55MM, JFM-5560-50		1
248	✘	BUSHING,OUTPUT TUBE, TOP,INSTNC		1
250	✘	RETAINING RING, 2 3/8"		1
252	✘	HUB, STEERING STOP, ANODIZED		1
254	✘	WASHER-THRUST, OUTPUT TUBE		1
256	✘	GREASE CAP BEARING		1
258	✘	HSG-TOP, STEERING,SW, BLK		1
260	✘	BUSHING, OUTPUT TUBE, LOWER		1
262	✘	BUSHING, JFM-2023-11		1

▲ Not shown on Parts Diagram.

✘ This part is included in an assembly and cannot be ordered individually.

PARTS DIAGRAM & PARTS LIST



Item	Part #	Description	Quantity
264	✘	VENT FILTER, STEERING HOUSING	1
266	✘	MNT, SENSOR, LATCH QRP	1
268	✘	SCREW-#4-24 X 1/4 PHCR SS TY B	2
270	✘	SCREW-#6-32 X .625 PPH SS	1
272	✘	SEAL, UMBRELLA	1
274	✘	SCREW-3/8-16 X 1.75 SHCS SSTL	4
276	✘	SCREW-1/4-20 X 1" SHCS SS	4
278	✘	SEAL, OUTPUT	1
280	✘	O-RING, SAE-010, BUNA-N	1
282	✘	SCREW-1/4-20 X .313 PLASTIC	1
284	2201925	BRACKET, LATCH RELEASE, RIGHT	1
286	2201926	BRACKET, LATCH RELEASE, LEFT	1
288	2207306	BUSHING, LATCH PIN	2
290	2202624	PIN-LATCH, OVERMOLDED	1
292	2202705	SPRING, COMPRESS, 1.25 L, 0.63 CMP	2
294	2207210	HANDLE, LATCH BRACKET	1
296	3393481	SCREW-#10X.75" PPH HI-LO (SUB)	4
298	✘	GEAR, 78 TOOTH, OUTPUT TUBE	1
300	✘	GROMMET, QRP SENSER HARNESS	1
302	✘	HARNESS, QRP SENSER, HALL EFF	1
304	2200845	CLAMP, TRIM-STEER, L, MACH	1
306	2200846	CLAMP, TRIM-STEER, R, MACH	1
308	2333101	NUT-HEX #10-24 UNC-2B NYL SS	2
310	2206412	COVER, CABLE, STEER HOUSING	1
312	2206413	BACKING, CABLE COVER	1
314	2203441	SCREW-#6 X 1/2" THRD FORM, SSTL	2
316	2332101	SCREW-#8-32 X 1/2 (SS)	3
318	2383469	SCREW-#10-24 X 3/4, SS, BHCS	2

▲ Not shown on Parts Diagram.

✘ This part is included in an assembly and cannot be ordered individually.



PARTS DIAGRAM & PARTS LIST



ULTRERA QUEST TRIM HOUSING

Trim Housing Parts Diagram

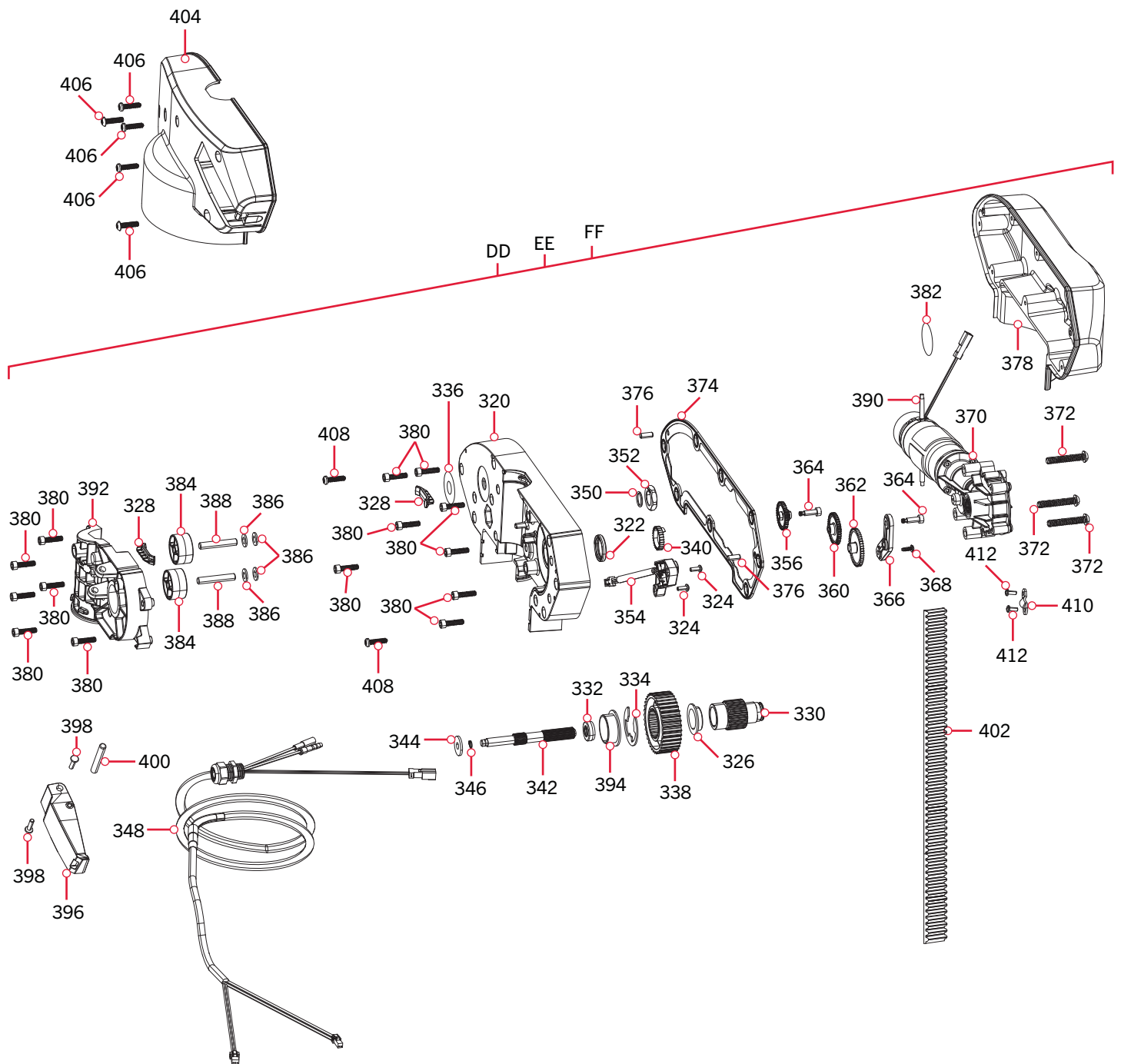

PARTS DIAGRAM & PARTS LIST

Trim Housing Parts List

Assembly	Part #	Description	Notes	Quantity
DD	2997851	ASM, TRIM MOD,FW, BLK,45"	*45"	1
EE	2997850	ASM, TRIM MOD,FW, BLK,60"	*60"	1
FF	2997852	ASM, TRIM MOD,FW, BLK,72"	*72"	1
Item	Part #	Description	Notes	Quantity
320	✘	HOUSING-MID,TRIM, SW, BLK		1
322	✘	SEAL,LIP,3/4 ID X 1 OD X 1/8 L		1
324	2073414	SCREW-#6-32 X .375 PPH SS(N/A)		2
326	✘	BUSHING, FLANGED, 3/4 SHAFT		1
328	2205126	BUMPER, WEAR, TRIM		2
330	✘	HUB, TRIM PULLEY, ANODIZE		1
332	✘	SEAL,LIP,5/16 ID X 3/4 ODX1/4L		1
334	2203030	RING, RETAIN, TRIM COUNT		1
336	2201727	WASHER, SLIP, TRIM		1
338	2202355	PULLEY, 38T, 1062-20 GROB IN		1
340	✘	GEAR, PINION, TRIM COUNT		1
342	✘	SPLINE SHAFT, PULLEY,TRIM		1
344	2201726	WASHER,ID .281, OD .75, T .075		1
346	2203032	RETAINING RING, 1/4"		1
348	✘	TRIM CORD ASM		1
350	✘	O-RING, HEYCO, 12X2MM, BUNA-N		1
352	✘	NUT, PG 9, STRAIN RELIEF		1
354	✘	SENSOR, TRIM, ROTATIONAL, I		1
356	✘	GEAR, 12T/35T		1
360	✘	GEAR, 13T/40T		1
362	✘	GEAR-TRIM SENSOR,48T, w/MAGNET		1
364	✘	BOLT-SHOULDER, #8-32 THD, SSTL		2
366	✘	CAP, TRIM MAGNET SENSOR GEAR		1
368	2372103	SCREW-#6 X .375 PLASTITE SS		1
370	✘	MOTOR, TRIM, 42MM, RIGHT ANGLE		1
372	✘	SCREW-1/4-20 X 1.50" BHCS SS		3
374	✘	GASKET, INSTINCT, TRIM		1
376	2202619	PIN-DOWEL, 3/16 X 1/2, SS		2
378	✘	HSG-MTR CVR, TRIM,SW, BLK		1
380	2203423	SCREW-#10-24 x .75, SHCS, SS		14
382	✘	VENT PATCH, YLW/BLK		1
384	2202352	PULLEY-IDLER, TRIM,REAMED		2

▲ Not shown on Parts Diagram.

✘ This part is included in an assembly and cannot be ordered individually.

PARTS DIAGRAM & PARTS LIST



Item	Part #	Description	Notes	Quantity
386	2201736	WASHER, PLASTIC,.265 ID, .5 OD		4
388	2202610	PIN, BELT PULLEY		2
390	2204635	SEAL, 1/16 O-RING CORD, SILICONE		1
392	2201521	COLLAR, OUTPUT TUBE, MACH		1
394	✘	BUSHING, FLANGED, 1.0 SHAFT		1
396	2200115	LEVER, TRIM RELEASE, MACH.		1
398	2202670	PIN, KNURL, HEAD, 4MM X 8MM		2
400	2202639	PIN-DOWEL, 1/4 X 1.75 LG		1
402	✘	BELT-LIFT 5MM HTD		1
404	2206524	TRIM HOUSING, OD COVER FW		1
406	2383469	SCREW-#10-24 X 3/4, SS, BHCS		5
408	3393481	SCREW-#10X.75" PPH HI-LO (SUB)		2
410	2200850	CLAMP, TRIM CABLE		1
412	2073414	SCREW-#6-32 X .375 PPH SS(N/A)		2

▲ Not shown on Parts Diagram.

✘ This part is included in an assembly and cannot be ordered individually.



ULTRERRA QUEST FOOT PEDAL

Foot Pedal Parts Diagram

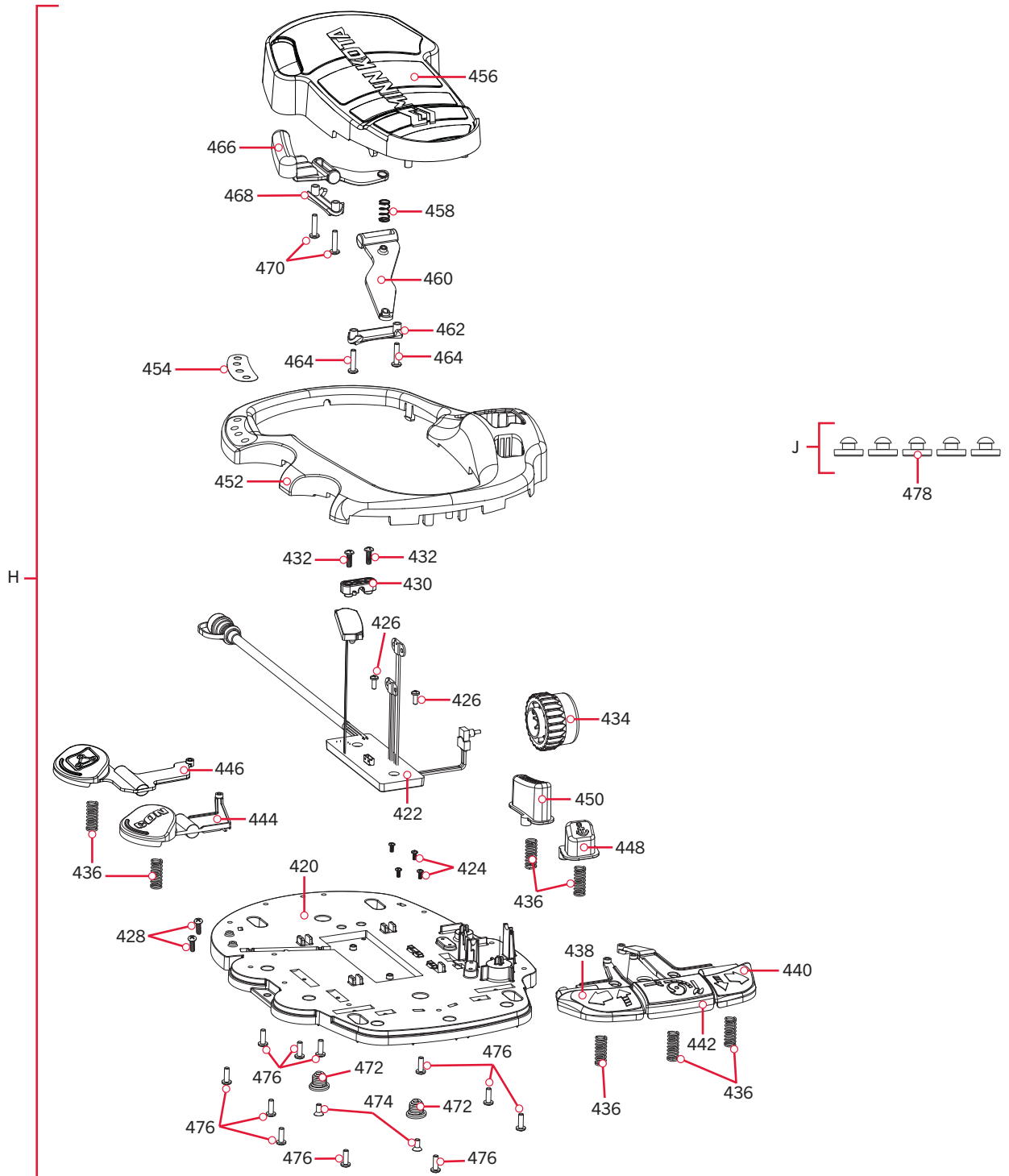

PARTS DIAGRAM & PARTS LIST

Foot Pedal Parts List

Assembly	Part #	Description	Quantity
H	2994742	FT PED ASM, ULTERRA QUEST	1
J	2994859	BAG ASY-TERROVA/V2,RUB.BUMPERS	1
Item	Part #	Description	Quantity
420	2204501	BASE PLATE, FOOT PEDAL	1
422	✘	PCB ASM, FT PED,ULTERRA	1
424	2373440	SCREW-#4-24 X 1/4 PHCR SS TY B	4
426	2372103	SCREW-#6-20 X 3/8 THD*(SS)	2
428	2302100	SCREW-#6-20 X 1/2 THD CUTS	2
430	2322900	STRAIN RELIEF, FOOT PEDAL	1
432	2372100	SCREW-#8-18 X 5/8 THD* (SS)	2
434	2320100	KNOB-SPEED, FOOT PEDAL	1
436	2322704	SPRING, LARGE SHORT SS	7
438	2203710	BUTTON,LFT STR w/TRIM UP ARROW	1
440	2203711	BUTTON,RGT STR w/TRIM UP ARROW	1
442	2203715	BUTTON, MOMENTARY/STOW-DEPLOY	1
444	2323715	BUTTON,MOM/CON,FT PEDAL	1
446	2203730	BUTTON, OBN, FOOT PEDAL	1
448	2203720	BUTTON, SPOT LOCK,ULTERRA/TRRV	1
450	2203725	BUTTON, MODE, ULTERRA	1
452	2200201	COVER,HEEL TOE FT PEDAL OBN	1
454	2205607	DECAL, 4 LED INDICATORS, FP	1
456	2324401	PEDAL,HEEL/TOE FOOT PEDAL	1
458	2322714	SPRING (LEE #LC-029E-4-S) SS	1
460	2328600	FLEX FINGER, FOOT PEDAL	1
462	2321300	CLAMP-LEFT, FT PEDAL	1
464	2223430	SCREW-#8x3/4 PPH,TYPE 25,SS	2
466	2323710	BUTTON,MOM LEFT,FT PEDAL	1
468	2321300	CLAMP-LEFT, FT PEDAL	1
470	2223430	SCREW-#8x3/4 PPH,TYPE 25,SS	2
472	2322706	SPRING-BARREL SS	2
474	2323421	SCREW-#8-18 X 1/2" PFH SS TY B	2
476	2301310	SCREW-#8-18 X 1/2 (SS)*	11
478	2325110	PAD, FOOTPEDAL	5

▲ Not shown on Parts Diagram.

✘ This part is included in an assembly and cannot be ordered individually.

PARTS DIAGRAM & PARTS LIST

Mount Parts List

Assembly	Part #	Description	Notes	Quantity
K	2994948	BAG, ASM, INSTINCT, T3 BL HDW		1
Item	Part #	Description	Notes	Quantity
490	2372103	SCREW-#6 X .375 PLASTITE SS		2
492	2201906	BASE, EXTRUSION, MACHINED FW		1
494	2205106	PAD, DEAD STOP, STOW		1
496	2373434	SCREW-1/4-20 X 3/4 SS PPMS		2
498	2205518	DECAL-INSTRUCTIONS, TRIM BYPASS		1
500	2323211	STOP-DEAD, DEPLOY		2
502	2383469	SCREW-#10-24 X 3/4,SS,BHCS		6
504	2202907	STANDOFF,.5 ODX.19 IDX.44 L,PL		1
506	2333101	NUT-HEX #10-24 UNC-2B NYL SS		1
508	2203426	SCREW-#10-24 x 1.5 SS BHCS		1
510	2200828	CLIP-CORD BACKUP MT PLATE		1
512	2200829	CLIP-CORD MT BRACKET		1
514	2991245	COIL CORD ASM 45" - 60"	*45"* *60"*	1
	2991246	COIL CORD ASM 72"	*72"*	1
516	✘	STRAIN RELIEF, MOUNT INSTINCT		1
518	2997925	CAM, LATCH, SENSOR w/MAGNET		1
520	2203510	BOLT-SHOULDER,POLYMER,CAM SNSR		1
522	2042711	SPRING-TORSION, SS		1
524	2997818	ASM, TILT ACTUATOR, FW BLK		1
526	2202326	SUPPORT, TILT SHAFT MID		1
528	2373440	SCREW-#4-24 X 1/4 PHCR SS TY B		3
530	2202930	SPACER, TILT LINKS		2
532	2993300	KNUCKLE,TILT 3/4-8 w/MAG		1
534	2204220	LINK-TILT, LEFT		1
536	2204225	LINK-TILT, RIGHT		1
538	2207331	BUSHING, E-PIN ECCENTRIC		1
540	2203410	SCREW-#10-32 X .5"		4
542	2202324	SUPPORT,TLT SHFT END,REAM		1
544	2207341	BUSHING, RFI-0810-10		1
546	2373481	SCREW-#10-32 X 1/2"SEMS PPH SS		3
548	2263452	SCREW-1/4-20 X 3/4 SHCS S/S		2
550	2073410	SCREW-1/4-20 X 1.125 SHCS SS		2
552	2203120	NUT-1/4-20 NYLOK, RIE COATED		2
554	2204030	CTRL BOARD ASM, MAIN ULTERRA 2		1

▲ Not shown on Parts Diagram.

✘ This part is included in an assembly and cannot be ordered individually.

PARTS DIAGRAM & PARTS LIST



Item	Part #	Description	Notes	Quantity
556	2373487	SCREW-#8-32 X 3/4" PPH MACH SS		4
558	2205412	SHRINK TUBE.75 ID x 2"		1
560	2202623	PIN,QCK REL. 5/16 x 3 1/2		1
562	2052510	CABLE CLAMP, 3/16", NYLON		8
564	2040721	CLAMP-CABLE 3/8"		2
566	2052511	CABLE CLAMP,1/4" VANTAGE		2
568	2073414	SCREW-#6-32 X .375 PPH SS(N/A)		12
570	2203440	SCREW-#4-40 X 1/4 PPH SS		4
572	2373440	SCREW-#4-24 X 1/4 PHCR SS TY B		2
574	2200625	LEADWIRE ASM,8AWG,ULT 2 (DPLX)		1
576	2202919	STRAIN RELIEF, POWER		1
578	2323405	SCREW-1/4-20 X 1/2" MCH SS		2
580	830-123	SCREW-M4 X .7X8MM HEX DBL SEMS		4
582	2294610	SEAL, PCBA TERMINAL GRAY .215		2
584	2294611	SEAL, PCBA TERMINAL BLACK .270		2
586	2203930	RAMP-MOTOR, RIGHT		1
588	2203935	RAMP-MOTOR, LEFT		1
590	2997907	RAMP/ACTUATOR ASM w/MAGNET		1
592	2263453	SCREW-1/4-20 X 1" SHCS S/S		4
594	2202708	SPRING-TORSION,RGT HND WIND,SS		1
596	2372100	SCREW-#8-18 X 5/8 THD* (SS)		1
598	2201723	WASHER-#6, .625 OD, SS		1
600	2203920	SIDEPLATE, RIGHT, BLACK		1
602	2203925	SIDEPLATE, LEFT, BLACK		1
604	2323405	SCREW-1/4-20 X 1/2" MCH SS		8
606	2205556	DECAL, SIDEPLATE RIGHT FW		1
608	2205557	DECAL, SIDEPLATE LEFT FW		1
610	2206515	HOUSING-CONTROL, BLACK		1
612	2205610	DECAL-PWR SWITCH, FW, BLK		1
614	2207311	BUSHING, STEER HOUSING PIVOT		2
616	2202650	SHAFT, SUPPORT, TILT		1
618	2373013	E-RING, EXTERNAL SS .625, HNDL		2
620	2383122	NUT 3/8-16 NYLON INST LOCKNUT		6
622	2378608	ANTI-SEIZE TUBE 4CC, TALON		1
624	2321710	WASHER, RUBBER MOUNT		6
626	2323440	SCREW-3/8-16X 2 1/2 HHCS SS		6
628	2371796	BACKUP BAR 3/16 X 1 X 2		6
630	2206576	RACK, BELT, TAPER, ANODIZED		1

▲ Not shown on Parts Diagram.

✳ This part is included in an assembly and cannot be ordered individually.



RECOMMENDED ACCESSORIES

› ON-BOARD & PORTABLE BATTERY CHARGERS

Stop buying new batteries and start taking care of the ones you've got. Many chargers can actually damage your battery over time – creating shorter run times and shorter overall life. Digitally controlled Minn Kota chargers are designed to provide the fastest charge that protect and extend battery life.



MK212PCL



MK210D



MK110PD

› TALON SHALLOW WATER ANCHOR

Talon is the only shallow water anchor with up to 15' of anchoring depth, multiple anchoring modes, and control from the bow, transom, console, remote or mobile device.



BUILT-IN WORK LIGHT

Lets you tie lines and work from the transom any time of day — or night. Includes both white and blue LED lights with three brightness settings.



BLUETOOTH® CONNECTIVITY

Lets you control Talon from your mobile device and easily update it. Also opens up communication to other control options.



UP TO 15' DEEP

Control more water and catch more fish with the first 15' shallow water anchor.



MORE CONTROL OPTIONS

- Control Panel
- Wireless Remote
- Mobile App
- Wireless Foot Switch
- Humminbird® Connectivity
- Advanced GPS Navigation System Remote



› MINN KOTA ACCESSORIES

We offer a wide variety of trolling motor accessories, including:

- 60-Amp Circuit Breaker
- Mounting Brackets
- Stabilizer Kits
- Boat Deck Reinforcement Kit
- Battery Connectors
- Battery Boxes
- Quick Connect Plugs



minnkota.johnsonoutdoors.com    

Part #2207124

Minn Kota Consumer & Technical Service
Johnson Outdoors Marine Electronics, Inc.
PO Box 8129
Mankato, MN 56001

121 Power Drive
Mankato, MN 56001
Phone (800) 227-6433
Fax (800) 527-4464



©2024 Johnson Outdoors Marine Electronics, Inc.
All rights reserved.

ECN 44630

Rev C

02/24